

## London Electronics Limited

Thorncote Road, Near Sandy, Bedfordshire SG19 1PU  
Tel +44(0)1767 626444 Fax +44(0)1767 626446  
www.london-electronics.com help@london-electronics.com

### Panel mounting Process display

# MAXI-INT4-P

## Installation & Operating Manual



- ✓ Easy setup
- ✓ Accepts 4-20mA, 0-10V, 1-5V etc
- ✓ Display = 3, 4, 5 or 6 digits (configurable)
- ✓ Optional Output 4-20mA / 0-10V isolated
- ✓ Optional Alarm output = 2 or 4 relays
- ✓ Optional Comms Output = RS232 or RS485
- ✓ 110-230V AC or 11-30V DC power

**Caution:** There is a risk of electrical shock if this instrument is not properly installed



**Caution:** Risk of danger: Read the whole manual before you install this meter



# Warranty

We warrant this product against defects in materials or workmanship for a period of three (3) years from the date of purchase.

In the event of a defect during the warranty period, the unit should be returned, freight (and all duties and taxes) prepaid by the Buyer to the authorised distributor from where the unit was purchased.

The Distributor, at its option, will repair or replace the defective unit. The unit will be returned to the Buyer with freight charges prepaid by the distributor.

## LIMITATION OF WARRANTY

The foregoing warranty shall not apply to defects resulting from:

1. Improper or inadequate maintenance by the buyer.
2. Unauthorised modification or misuse.
3. Operation outside the environmental specification of the product.
4. Mishandling or abuse.

The warranty set forth above is exclusive and no other warranty, whether written or oral is expressed or implied. We specifically disclaim the implied warranties of merchantability and fitness for a particular purpose.

## EXCLUSIVE REMEDIES

The remedies provided herein are the buyer's sole and exclusive remedies.

In no event shall we be liable for direct, indirect, incidental or consequential damages (including loss of profits) whether based on contract, tort or any other legal theory.

# Contents

Warranty	2
Warnings	4
Introduction	5
General Description	6
Panel mounting & Installation - Class II	7
Wiring Advice	8
Connections	9
Installation hints for best performance	10-11
Declaration of Conformity	12
Language Selection	13
Display Brightness	14
Display Calibration Modes	15
Direct Calibration	16-17
Linearisation with Direct Calibration	18-19
Theoretical Calibration	20-21
Linearisation with Theoretical Calibration	22-23
Sensor Drift correction	24
Logic Input functions	25
Logic Input connections & Front Buttons	26
Factory defaults	27
Calibration Audit number	27
Signal Filtering / Averaging	28-29
Last Digit rounding	30
Scale Factor adjustment	31
Offset Adjustment	32
Menu Timeout adjustment	33
Reverse / Mirror display setting	34
Bootup Routine choices	35
Multi Memory MEM option	36
Error Codes	37
Output Options - installing	38
WEEE	38
Equipment Specifications	40
Record of Revisions	41

## **Separate manuals for options**

Alarm option settings	See Alarm manual *
Analogue output option settings	See Analogue manual *
Serial output option settings	See Serial manual *
Real Time Clock setting	See Serial manual *

\* Need a manual urgently?

You can download manuals from our website

# Warnings

Please carefully read this manual and all warnings. Install the meter ONLY when you are sure that you've covered all aspects.



Where the product is intended for "UL" installations, removal or addition of option boards is not permitted.



Check that the model number and supply voltage suit your application before you install the meter.



Connect the meter according to current IEE regulations, IEC61010 & NFPA:70 National Electric Code in USA.



This meter is for Installation class II service only. This means it has exposed electrical and power terminals. You must install it in a suitable fire enclosure which will also protect users from electric shock



We designed this meter for Pollution-Degree 2 environments only.



Power supplies to this equipment must have anti-surge (T) fuses rated at 400mA for 230V supply, 400mA for 110V supply or 2A for DC supplies in the range 11-30VDC. Only Siba fuses in series 189500, cULus listed according to file #E167295 are accepted for this service under the terms of UL listing. A switch or circuit breaker, clearly marked as a disconnecting device, must be included close to the installation.



Don't touch any circuitry after you have connected the meter, because there may be lethal voltages on the circuit board.



Only adjust on-board switches or connections with the power turned off



Make sure all screw terminals are tight before you switch the meter on.



Only clean the meter's front with a soft damp cloth. Only lightly dampen with water. Do not use any other solvents. The behind-panel case may be cleaned with a dry cloth only, use no liquid or solvent on it.

**Safety First .....Don't assume anything..... Always double check.  
If in doubt, ask someone who is QUALIFIED to assist you in the subject.**

# Introduction

Please contact us if you need help, if you have a complaint, or if you have suggestions to help us improve our products or services.

If you contact us about a product you already have, please tell us the full model number and serial number, so that we can give you accurate and fast help.

This product has a 3 year warranty. We will put right or replace any meter which is faulty because of bad workmanship or materials. This warranty does not cover damage caused by misuse or accident.

If you return a unit for repair, please include a detailed description of the problem, and the name of a contact who we can refer to for any questions. Please mark for the attention of the QA Department.

## **IMPORTANT**

If this equipment is important to your process, you may want to buy a spare to cover possible failure or accidental damage in the future.

This is because during factory shutdown periods, you may have to wait several weeks for an equivalent replacement, or we may have no stock at the time you urgently need it.

You may also need to pay extra carriage charges if you want a fast, guaranteed courier service. Warranty repairs or replacements are usually returned with a standard courier service.

We do not offer compensation for losses caused by failure of this instrument.

If you do not agree with these conditions, please return this item in unused, condition, in its original packaging and we will refund the purchase price, excluding any carriage paid.

We thought you'd prefer to know about possible delays and extra charges now, rather than during a panic. A spare unit could help to avoid these issues.

We always try to improve our products and services, so these may change over time. You should keep this manual safely, because future manuals, for new designs, may not describe this product accurately.

We believe these instructions are accurate, and that we have competently designed and manufactured the product, but please let us know if you find any errors.

# General Description

This series of meters accepts industrial sensors to allow various physical measurements to be made, such as weight, temperature, pressure, humidity etc. Different models are available for different sensor types.

The main function of this series is to give a numeric readout of the variable being monitored. Most models include an excitation power output, to power the sensor directly.

Various optional output modules are also available to give alarm relay outputs, analogue output or digital communications, or any combination of these options.

Meters are programmed using front panel pushbuttons. The buttons may be locked with a rear switch.

Meters have two power supply options : 100-240 VAC or 11-30VDC

These meters are designed to mount into a protective enclosure which will protect users from contact with power and signal wiring.

These units must be installed fully assembled, and must be installed according to local electrical installation rules. When used with SPC4-M splashproof covers, they provide ingress protection to IP65 / NEMA4X from the front

## Safety



**Caution:** There is a risk of electrical shock if this instrument is not properly installed



**Caution:** Risk of danger: Read the whole manual before you install this meter

Obey all safety warnings in this manual, and install the meter according to local wiring and installation regulations. Failure to follow these guidelines may cause damage to the meter, connected equipment, or may be harmful to personnel.

Any moving mechanical device controlled by this equipment must have suitable access guards to prevent injury to personnel if the meter should fail.

# Panel Mounting and Installation - Class II

Install these meters in a suitable protective electrical control enclosure according to local wiring regulations. See specifications for maximum allowable temperature in enclosure. Allow adequate air circulation.

**Installing into front of panel**  
Remove the two screw clamp assemblies and safely store them for later fitting.

138mm +1mm -0mm  
67.5mm +1mm -0mm  
Panel cutout

Slide the meter, with gasket into the panel cutout

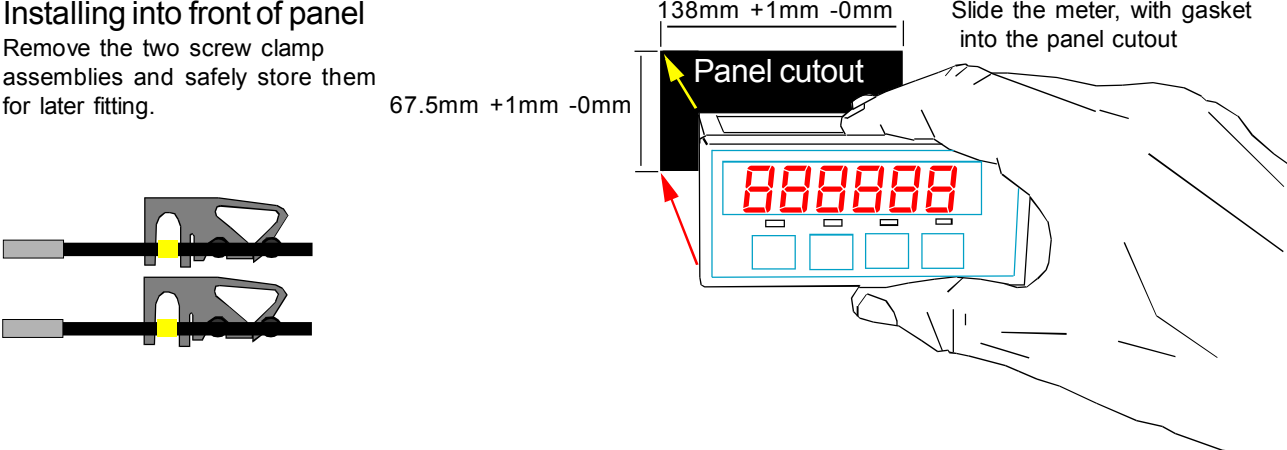

**Securing into the panel**  
Re-fit the screw clamp assemblies and tighten the screws to firmly clamp the meter in place.

**Ventilation**  
There should be sufficient ventilation in the enclosure to ensure that the meter's case is always kept to less than 60C.

**Meter Spacing.**  
Meters should be spaced apart sufficiently to allow a free flow of ventilation air around the meters, such that no part of the case will exceed 60C

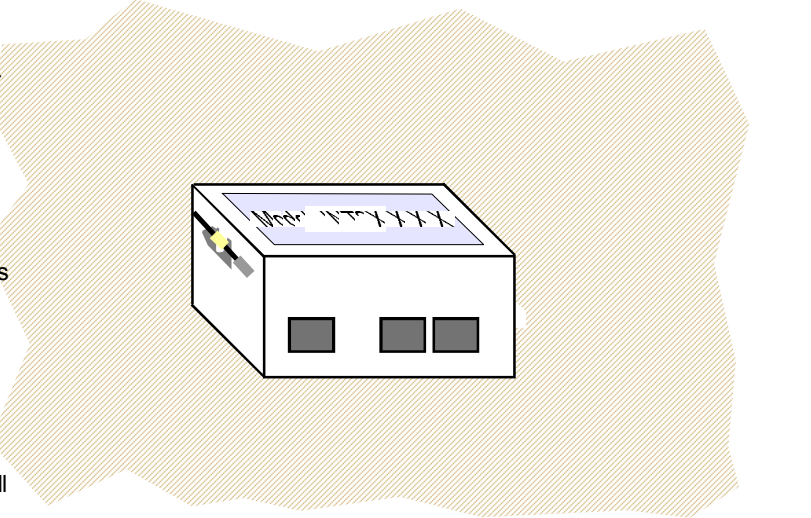

**Side view of meter installed in panel**

Connectors

Left side of meter case

Front surface of enclosure

Front surface of meter

Front surface of enclosure

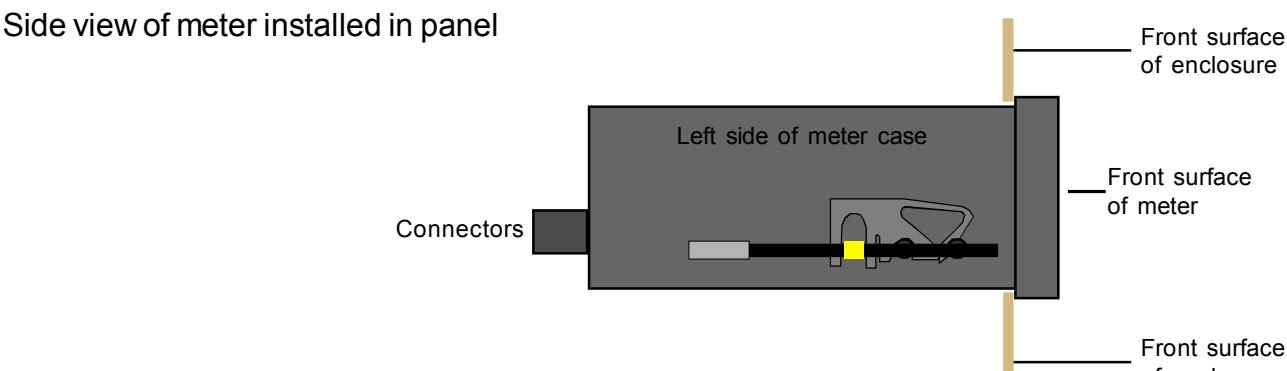

# Wiring Advice

This meter uses detachable screw terminal connectors. Refer to the wiring diagram on the following page for the correct positioning of each wire.

The conductors you use must be suitable for the meter's temperature, current and voltage rating, which is broadly described as follows:-

## Cable Temperature Rating

All cables must be rated for operation up to 90C continuous.

## Cable gauge and screw tightness

The connectors on this instrument can accept conductors up to 16 gauge AWG / 1.5mm<sup>2</sup> c.s.a. The minimum cross sectional area shall be 22 gauge AWG / 0.5mm<sup>2</sup>. Tighten screw terminals to 7.0 lb/in torque / 0.8 Nm torque.

## Cable insulation voltage rating

Cables shall have an insulation voltage rating of at least 380V continuous.

Wire preparation:

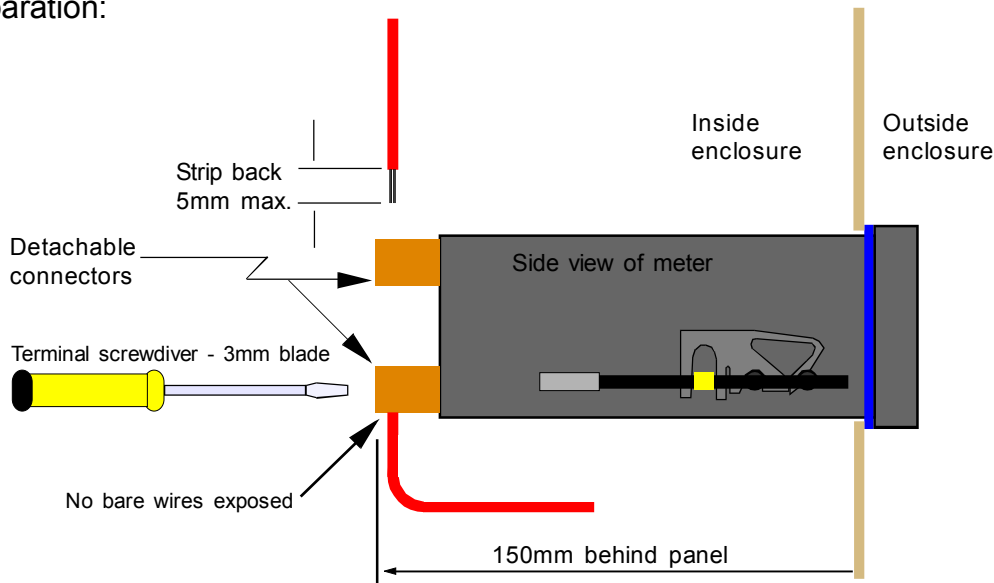

We recommend multi-strand wire, because it withstands vibration better than single strand cable. Pull the wire firmly after you make the connection to confirm it is tight.

Use screened cable for all signal and control wiring and connect the screen to earth at the destination end only. Route signal cabling away from power cabling and relay switching cabling, to avoid electrical noise interference.



# Connections

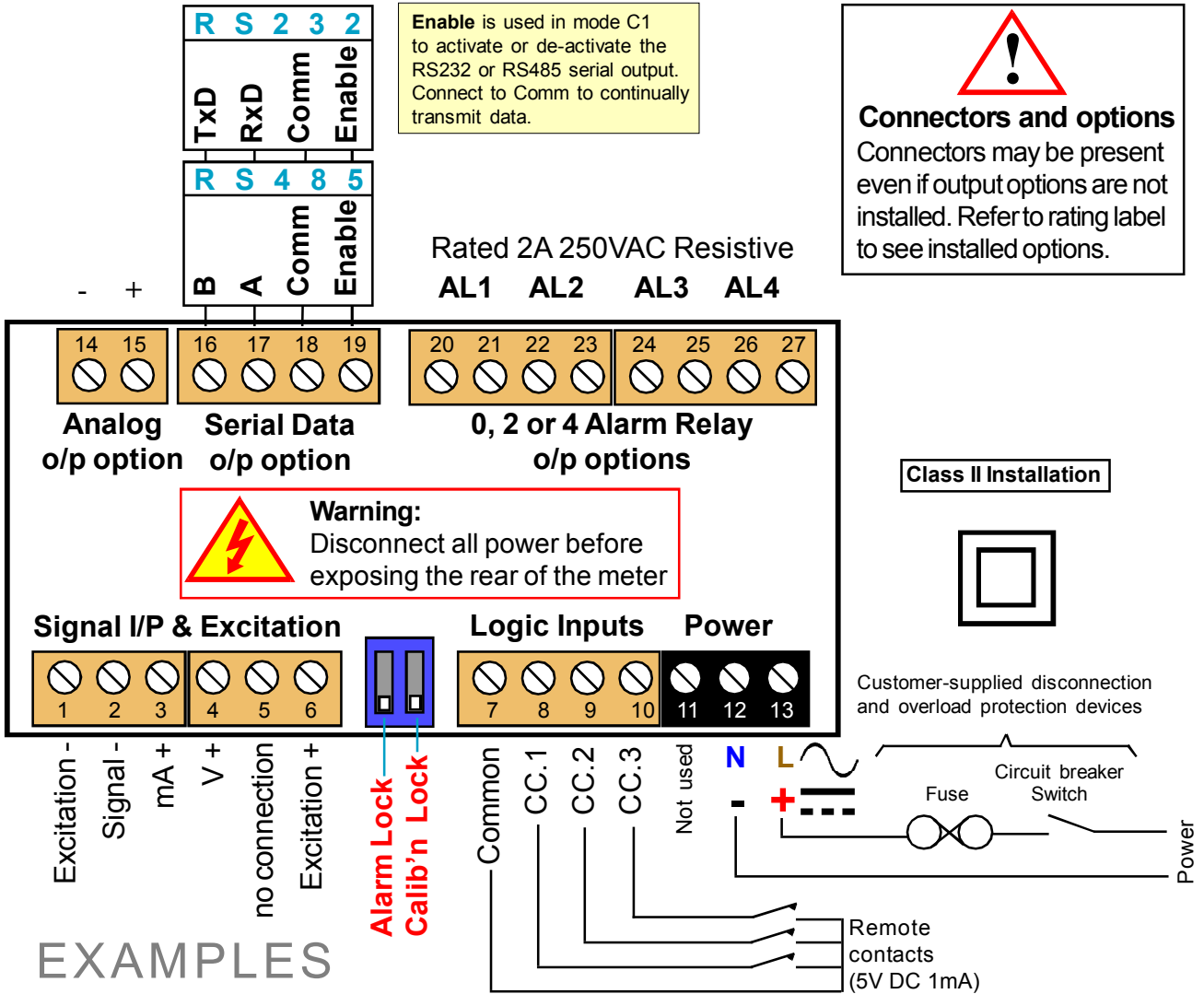

## EXAMPLES

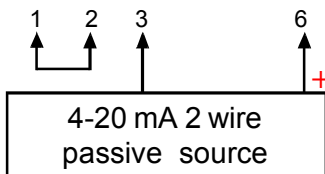
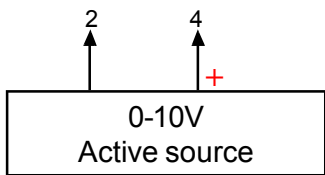
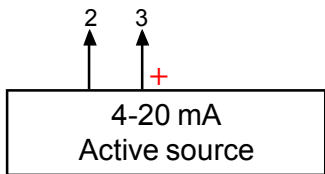

Note that terminals 1 and 2 must be linked.

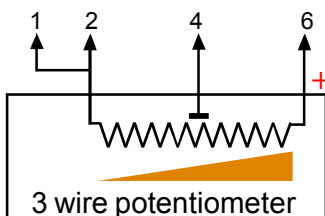

Only possible if you have -POT option installed, which provides 10V regulated excitation output.

# Installation hints for best performance

This section offers several suggestions which will help you get the best performance from your measurement system.

Some sensors generate comparatively small signals which can easily be corrupted by the potentially high level of electrical noise which can be created by electrical machinery such as motors, welding systems, discharge lighting, AC power inverters and solenoids. These steps will ensure you get the best possible performance from your system.

1. Use good quality screened signal cable, with twisted pairs. Belden 8777NH, Belden 9503 and AlphaWire 6010C are good choices, available from many electrical distributors.
2. If you are using multi-pair twisted cable, each pair should be dedicated to a single display as shown opposite, for maximum noise immunity. This will ensure that any electrical noise induced in the cable is properly cancelled. Mixing destinations carelessly amongst the twisted pairs can actually worsen noise performance.
3. The cable should be routed away from noisy wiring and devices such as power feeds from inverters, discharge-lighting cables, welder cabling etc, and should preferably be routed in a dedicated low voltage signalling/instrumentation conduit or cable tray.
4. Screened cable should be earthed at the display end only.
5. All wires and screens coming out of the screened cable should be kept as short as possible to minimise pickup of noise.
6. If you are using barriers, you should earth your screen as shown below, paying particular care that you do not earth both ends of any run of of cable.

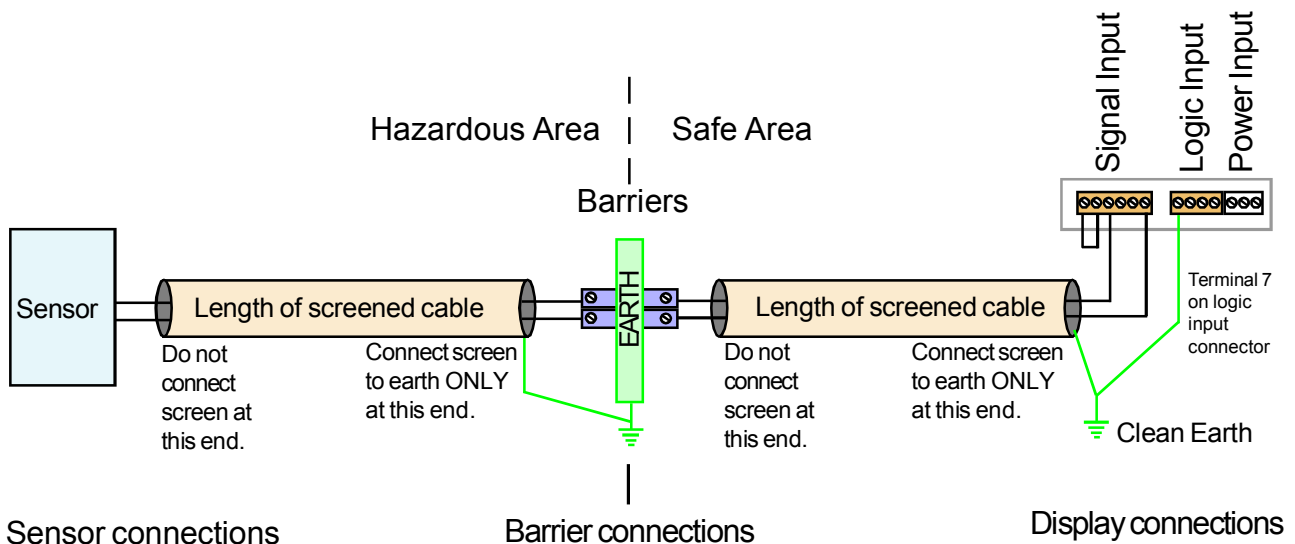

When using multi-core screened cable to connect several displays to several sensors, please be sure to use one twisted pair for each display and sensor.

Do NOT use a wire from one pair for signal positive and a wire from another pair for signal negative, as this will prevent the twisted cables from cancelling any induced electrical noise.

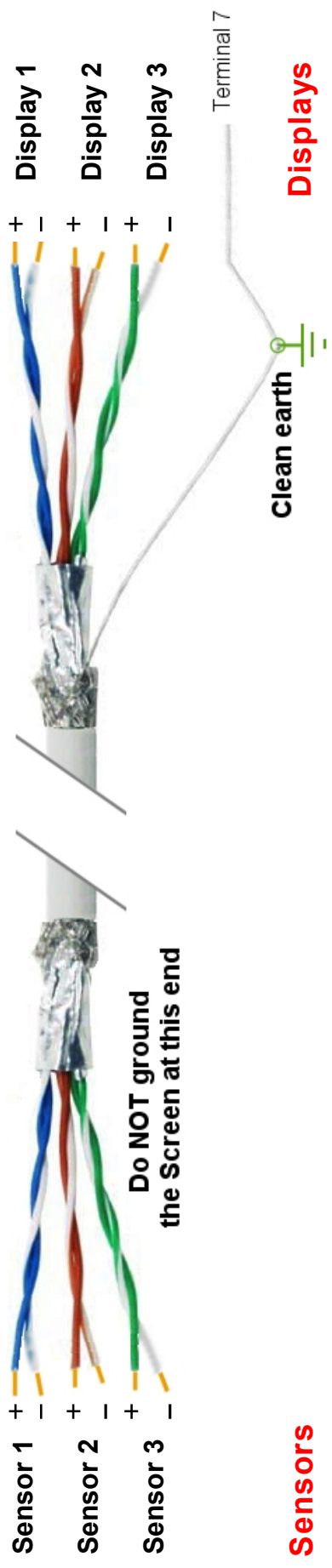

# Declaration of UK & CE Conformity



Declaration Reference : INTUITIVE Mk4  
Issue Date : 20 September 2022  
Products Covered : INTUITIVE Mk4 series  
Title : DOC-INTUITIVE4

We hereby self-certify that the design and manufacture of this product conforms with the UKCA and CE standards, by complying with the directives and standards below.

Electrical Equipment (Safety) Regulations, 2016 and amendments  
Low Voltage Directive 2014/35/EU  
BS EN 61010-1 : 2010 + A1 : 2019

Electromagnetic Compatibility Regulations, 2016 and amendments  
EMC Directive 2014/30/EU  
EN 61326-1 : 2013

Immunity for equipment intended to be used in an industrial electromagnetic environment.

Maximum errors of 1% of dynamic range are permitted.  
Instrument must recover automatically from disturbance.

Restriction of the Use of Certain Hazardous Substances in Electrical and Electronic Equipment Regulations, 2012 and amendments  
RoHS2 directive incorporating RoHS3 Amendment 2015/863/EU  
EN IEC 63000 : 2018

## Conditions

The meters are permitted a worst case error of 1% of A/D range during electro-magnetic disturbance, and must recover automatically when disturbance ceases without the need for human intervention, such as resetting, power-down etc.

The meters covered by this certificate must be installed in adherence to the following conditions :-

Signal cabling shall be routed separately to power carrying cabling (includes relay output wiring)

All signal cabling shall be screened. The screen shall only be terminated to the power earth terminal at the meter end of the cable.

Declared as true and correct, for and on behalf of London Electronics Ltd.

J.R.Lees Director

# Language Selection for user interface

You can select English or French menu prompts.

**1**

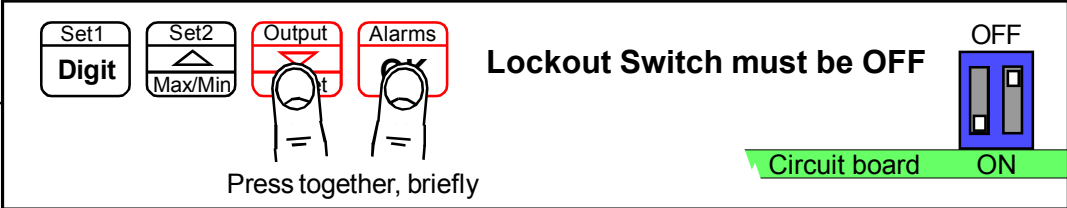

Set1 Digit Set2 Max/Min Output Alarms

Lockout Switch must be OFF

Circuit board ON

Press together, briefly

**2**

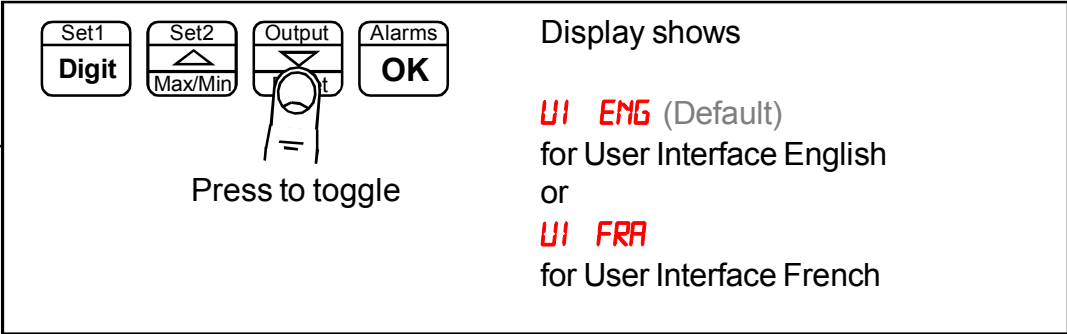

Set1 Digit Set2 Max/Min Output Alarms OK

Display shows

UI ENG (Default)  
for User Interface English  
or  
UI FRA  
for User Interface French

Press to toggle

**3**

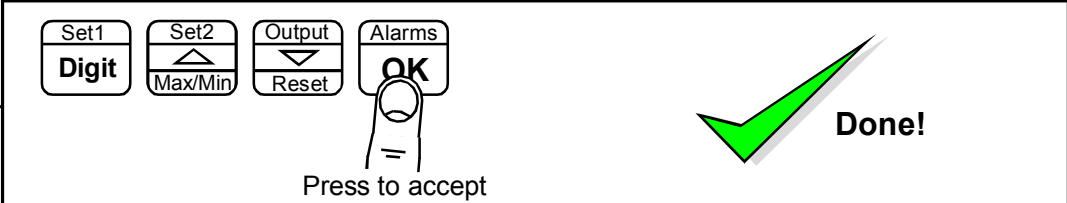

Set1 Digit Set2 Max/Min Output Reset Alarms OK

Done!

Press to accept

# Display Brightness

You can adjust the display brightness at any time, provided the display is locked.

**1**

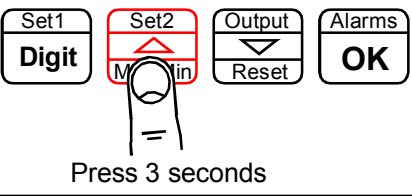

Set1 Digit Set2 Max/Min Output Reset Alarms OK

Lockout Switch must be ON

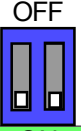

Circuit board ON

Press 3 seconds

**2**

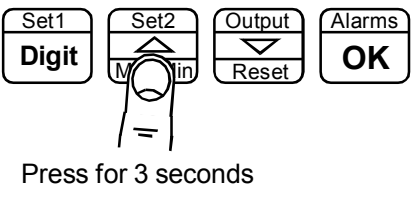

Set1 Digit Set2 Max/Min Output Reset Alarms OK

Display shows **BRIGHT**

Each press of the UP button will select a new brightness level. There are 7 brightness levels to choose from. (Default = Full brightness)

Press for 3 seconds

**3**

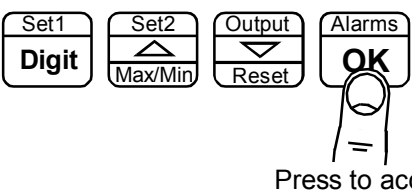

Set1 Digit Set2 Max/Min Output Reset Alarms OK

Done!

Press to accept



Did you know, we make this display in two brightness versions? Standard brightness for use inside, and Daylight Viewing for use outside in direct sunlight. The Daylight Viewing version has suffix -DLV in its part number.

# Meter Calibration Modes

You can choose from two main calibration methods.

**1. Direct Calibration** - this is when you connect the meter to your system and make the meter read what you want it to, at 2 different points. *This is the preferred calibration method, because it allows you to calibrate the system as a whole.*

**2. Theoretical Calibration** - this is when you type in the sensor's theoretical signal level at the bottom and top of its range and then type in the value the display should show, for each signal level.

How to choose a calibration method:-

**1**

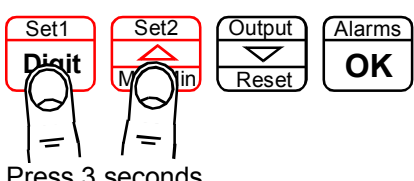

Set1 Digit Set2 Max/Min Output Reset Alarms OK

Press 3 seconds

Lockout Switch must be OFF



Circuit board ON

**2**

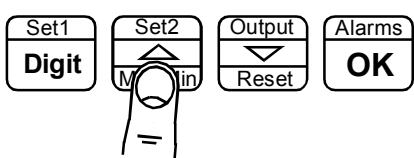

Set1 Digit Set2 Max/Min Output Reset Alarms OK

Press to select dirECT or thEor

Display shows **CAL SRC** then **DIRECT** or **THEOR** (Default)

**3**

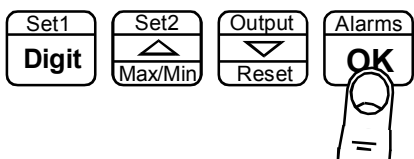

Set1 Digit Set2 Max/Min Output Reset Alarms OK

Press to accept

If you chose Theoretical, you will now be asked whether your input signal will be DC Current or DC voltage ... the display will show **INPUT** followed by **DC A** or **DC V**

**4**

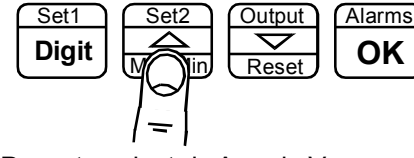

Set1 Digit Set2 Max/Min Output Reset Alarms OK

Press to select dc A or dc V

Display shows **INPUT** then **DC A** for current or **DC V** for voltage (Default)

**5**

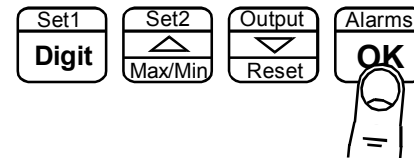

Set1 Digit Set2 Max/Min Output Reset Alarms OK

Press to accept



Done!

# Direct Calibration - Full Scale Setting

This is when you connect the meter to your system and make the meter read what you want it to, at 2 different points. *This is the preferred calibration method, because it allows you to calibrate the system as a whole.*

How to do direct calibration:-

If you have not done so before, please select Direct Calibration mode from the previous page.

First we recommend you set the **FULL SCALE** calibration ...

- 1**

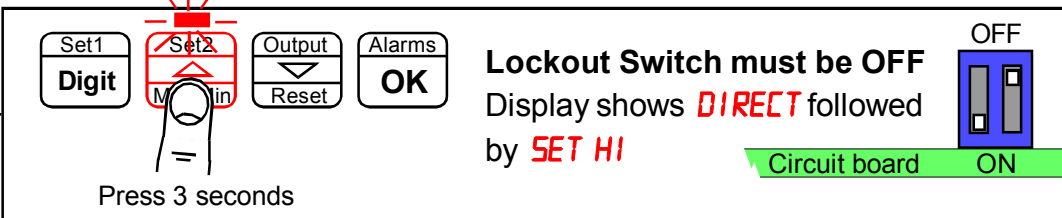

Press 3 seconds

Lockout Switch must be OFF  
Display shows **DIRECT** followed by **SET HI**

Circuit board ON
- 2**

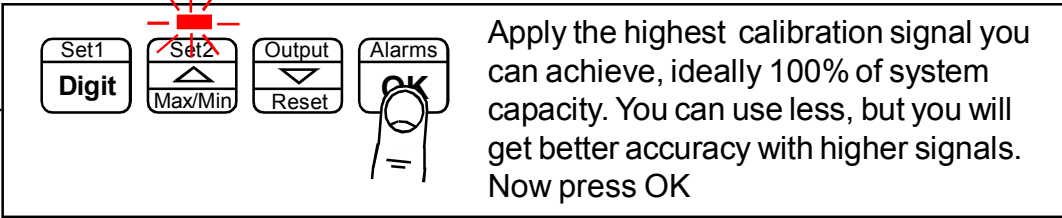

Apply the highest calibration signal you can achieve, ideally 100% of system capacity. You can use less, but you will get better accuracy with higher signals. Now press OK
- 3**

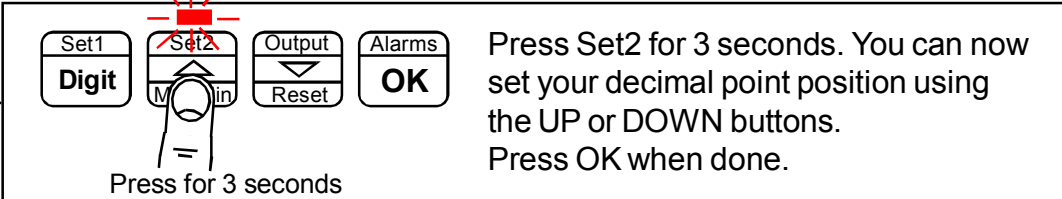

Press for 3 seconds

Press Set2 for 3 seconds. You can now set your decimal point position using the UP or DOWN buttons. Press OK when done.
- 4**

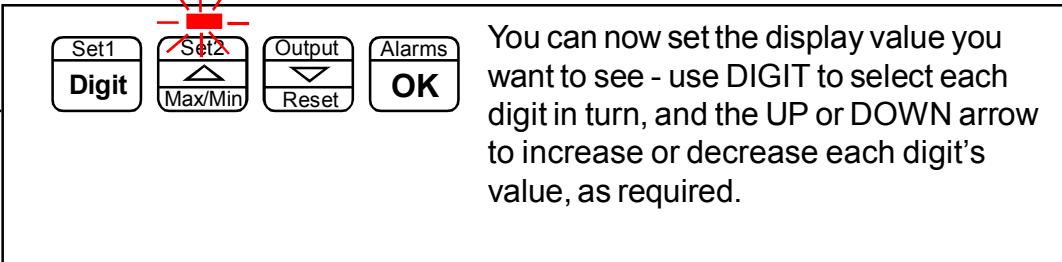

You can now set the display value you want to see - use DIGIT to select each digit in turn, and the UP or DOWN arrow to increase or decrease each digit's value, as required.
- 5**

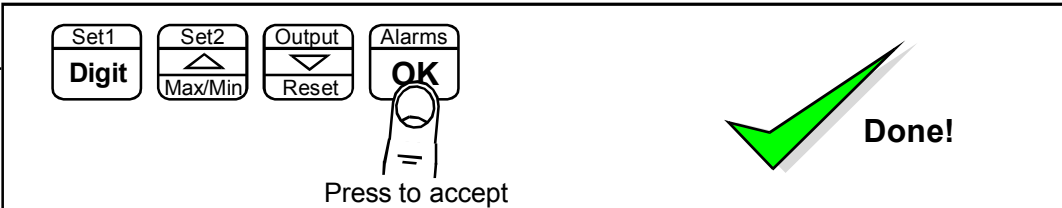

Press to accept

**Done!**



# Direct Calibration - Zero Setting

How to calibrate the **ZERO** point.

- 1**

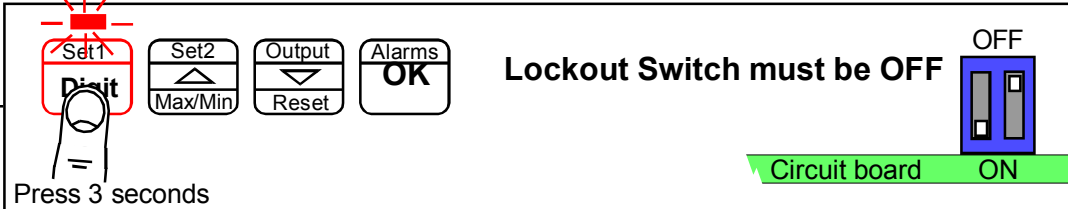

Press 3 seconds

Lockout Switch must be **OFF**

Circuit board **ON**
- 2**

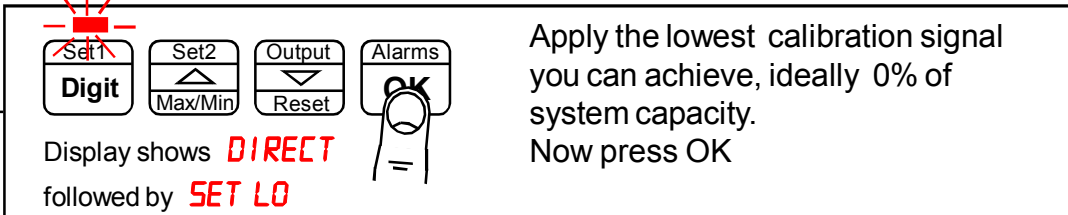

Display shows **DIRECT** followed by **SET LO**

Apply the lowest calibration signal you can achieve, ideally 0% of system capacity. Now press OK
- 3**

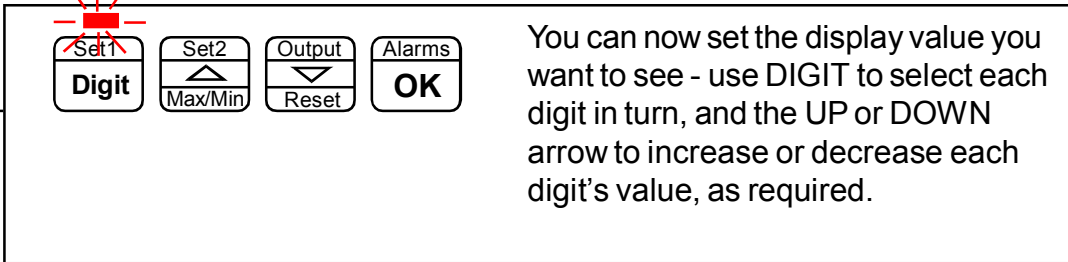

You can now set the display value you want to see - use DIGIT to select each digit in turn, and the UP or DOWN arrow to increase or decrease each digit's value, as required.
- 4**

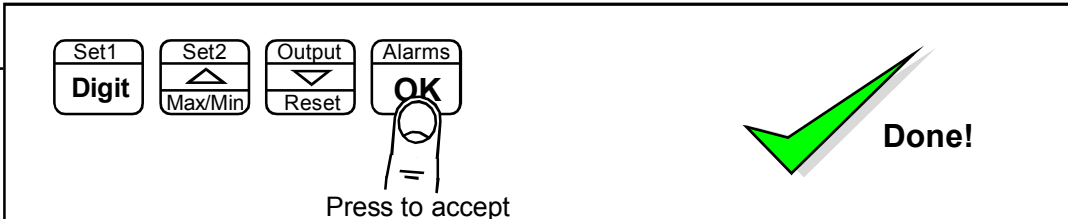

Press to accept

**Done!**

You can set Zero first, if you prefer, but you will not be able to change the decimal point position in the ZERO calibration step.

This will not be an issue if your zero calibration reading is 0, but may become confusing otherwise.

When you have finished your calibration, please remember to put the calibration lockout switch in its ON position, to protect your settings.

# Linearisation with Direct Calibration

If your system is non linear, you can calibrate the meter and correct for this with the lineariser function.

You will need to apply a series of known loads, starting at 0 and working up to full scale. You will then tell the meter what it should read for each applied load. You can use up to 10 points.

First, you must select Direct Calibration Mode (see page on calibration Modes)  
Then, proceed as shown below...

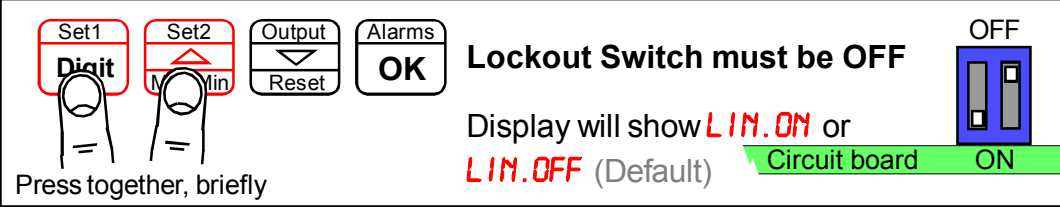
- 

**1** Press together, briefly

**Lockout Switch must be OFF**

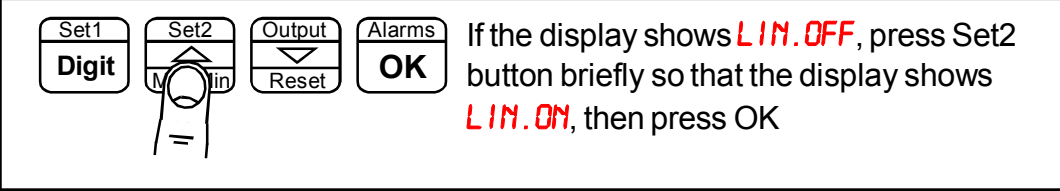
Display will show **LIN.ON** or **LIN.OFF** (Default)
- 

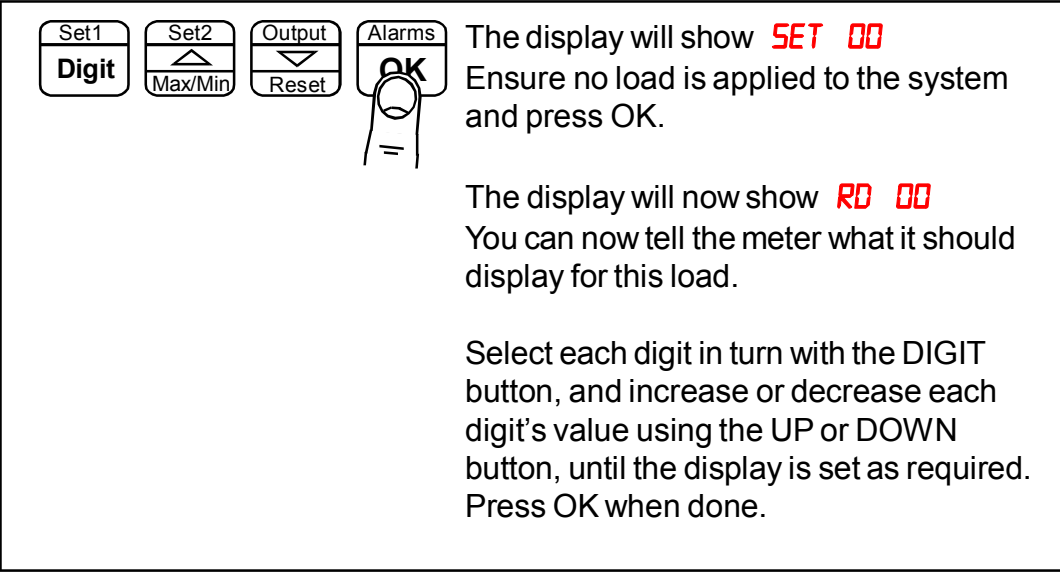
**2** If the display shows **LIN.OFF**, press Set2 button briefly so that the display shows **LIN.ON**, then press OK
- 

**3** The display will show **SET 00**  
Ensure no load is applied to the system and press OK.

The display will now show **RD 00**  
You can now tell the meter what it should display for this load.

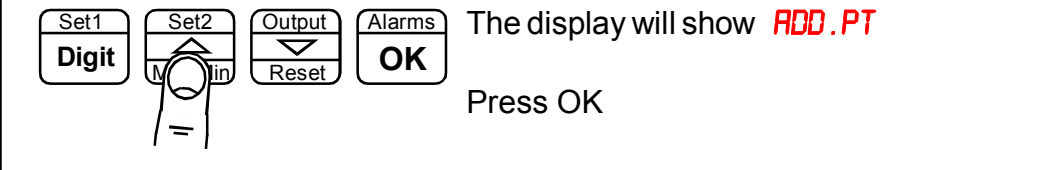
Select each digit in turn with the DIGIT button, and increase or decrease each digit's value using the UP or DOWN button, until the display is set as required. Press OK when done.
- 

**4** The display will show **ADD.PT**  
Press OK

Continued ...

# Linearisation with Direct Calibration - cont'd.



5

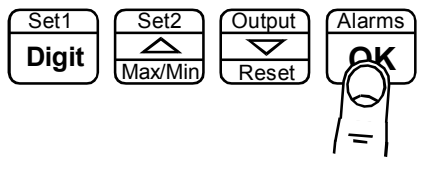

The display will show **SET 01**  
Apply your 1st known load to the system and press OK.

The display will now show **RD 01**  
You can now tell the meter what it should display for this load.

Select each digit in turn with the DIGIT button, and increase or decrease each digit's value using the UP or DOWN button, until the display is set as required. Press OK when done.

6

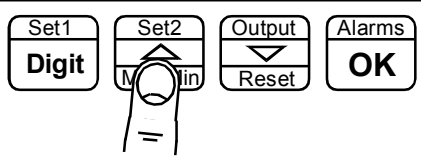

The display will show **ADD.PT**

Press OK if you want to Add another calibration point, you will repeat the previous steps, each time incrementing "Set XX" and "rd XX" up to Set 09 and rd 09 which are the last available points.

If you want to finish adding points, press Set2 until the display shows **SAVE**, and then confirm by pressing OK

If you want to abort the setup, press Set2 until the display shows **QUIT** and then press OK

7

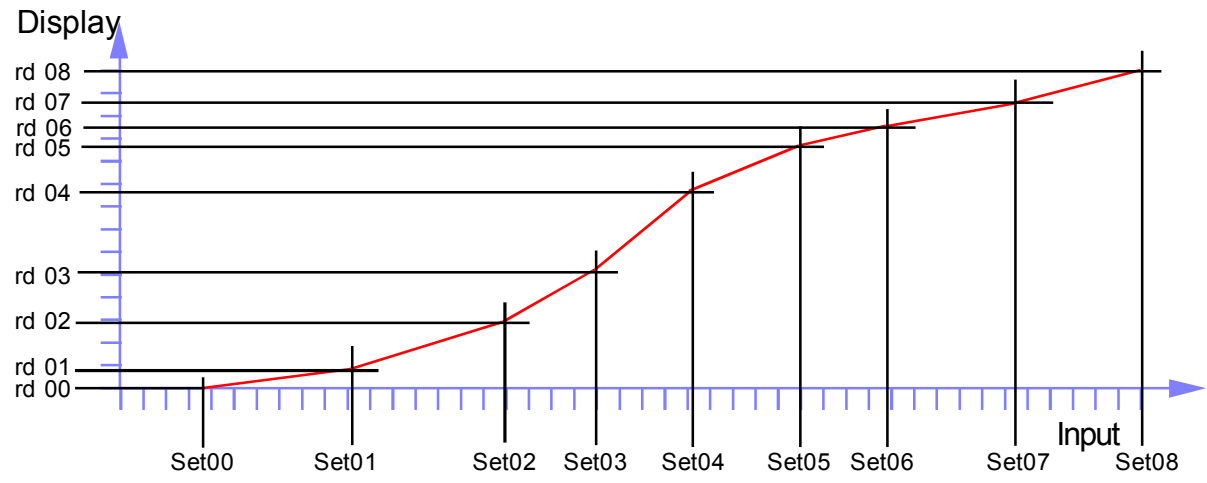
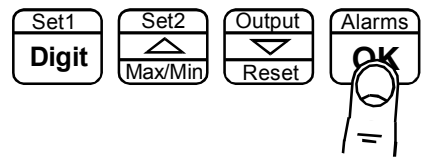

# Theoretical Cal. - Decimal Point & Full Scale

This is when you type in the sensor's theoretical signal level at the top and bottom of its range and the value to display, for each signal level.



If you have not done so before, please select Theoretical Calibration mode from the **Meter Calibration** page AND choose whether your input is current or voltage.

First we recommend you set the **FULL SCALE** calibration ...

1	<p>Press 3 seconds</p>	<p><b>Lockout Switch must be OFF</b></p> <p style="text-align: right;">Circuit board ON</p>
2		<p>Display shows <b>THEOR</b> followed by <b>DC A</b> or <b>DC V</b>, depending on whether you have chosen current or voltage input, then <b>IN HI</b></p>
3	<p>Press to accept</p>	<p>You can now specify the maximum input signal. Use DIGIT to select each digit in turn, and the UP or DOWN arrow to increase or decrease each digit's value, as required. eg set <b>20.0000</b> if your input is 4-20mA</p>
4		<p>Display now shows <b>RD HI</b> briefly. You can now specify the maximum reading and decimal point position. Press Set2 button for 3 seconds to set decimal point position. Use up and down arrows to move the decimal point and press OK when done. Then, use DIGIT to select each digit in turn, and the UP or DOWN arrow to increase or decrease each digit's value, as required. eg set 100.000 if your display range is 0 to 100.000</p> <p>Defaults are              4-20mA = 0-100.00 for dCA              and              0-10V = 0-100.00 for dC V</p>
5	<p>Press to accept</p>	<p><b>Done!</b></p>

# Theoretical Calibration - Low end calibration

This is when you type in the sensor's theoretical signal level at the top and bottom of its range and the value to display, for each signal level.

If you have not done so before, please select Theoretical Calibration mode from the **Meter Calibration** page.

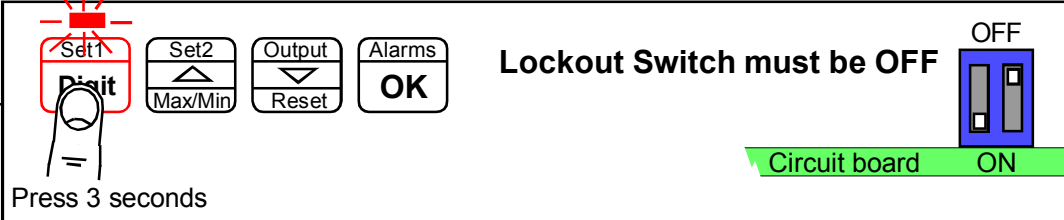
- 

1 — Press 3 seconds

Lockout Switch must be OFF

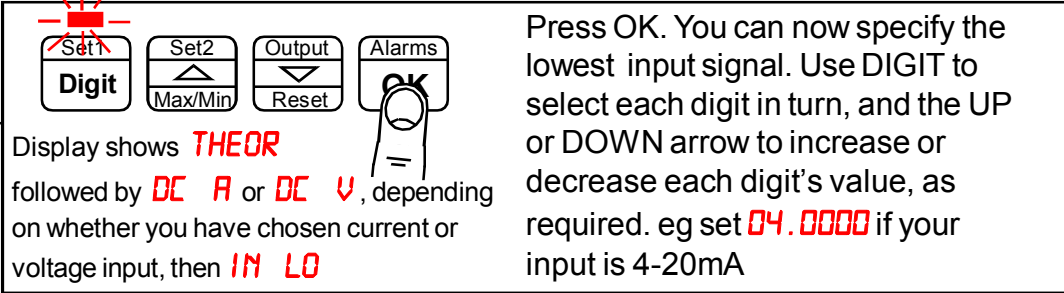
Circuit board ON
- 

2 — Display shows **THEOR** followed by **DC A** or **DC V**, depending on whether you have chosen current or voltage input, then **IN LO**

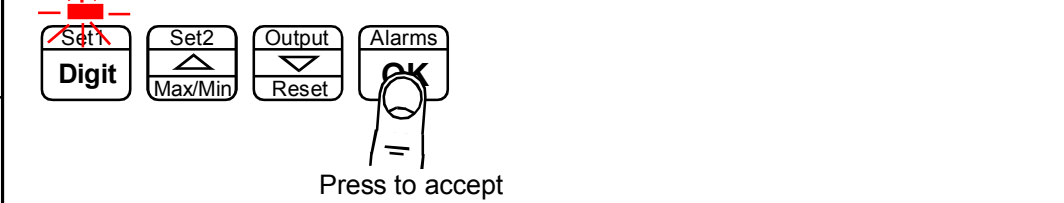
Press OK. You can now specify the lowest input signal. Use DIGIT to select each digit in turn, and the UP or DOWN arrow to increase or decrease each digit's value, as required. eg set **04.0000** if your input is 4-20mA
- 

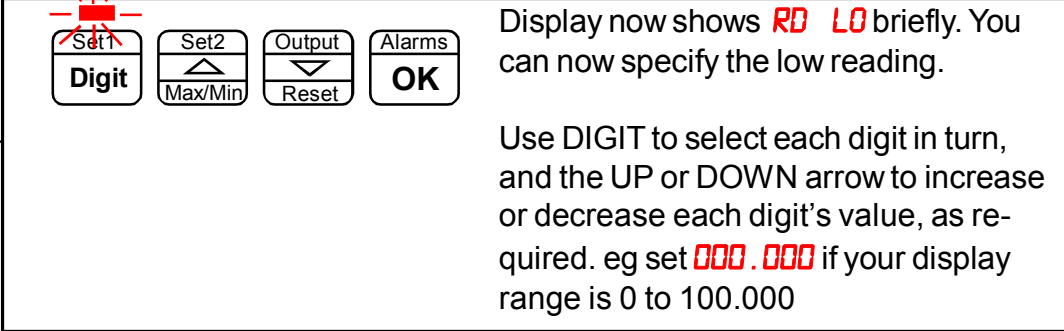
3 — Press to accept
- 

4 — Display now shows **RD LO** briefly. You can now specify the low reading.

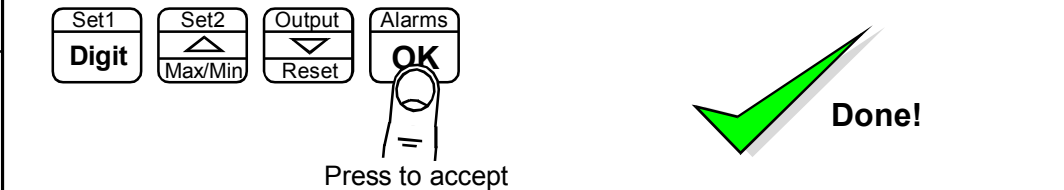
Use DIGIT to select each digit in turn, and the UP or DOWN arrow to increase or decrease each digit's value, as required. eg set **000.000** if your display range is 0 to 100.000
- 

5 — Press to accept

Done!

You can set Zero first, if you prefer, but you will not be able to change the decimal point position in the ZERO calibration step. This will not be an issue if your zero calibration reading is 0, but may become confusing otherwise.

# Linearisation with Theoretical Cal.

If your system is non linear, you can calibrate the meter and correct for this with the lineariser function.

With this method, you can enter theoretical values for input signal and display values, without having to connect a sensor.

First, you must select Theoretical Calibration Mode (see page on calibration Modes) Then, proceed as shown below...

- 1**

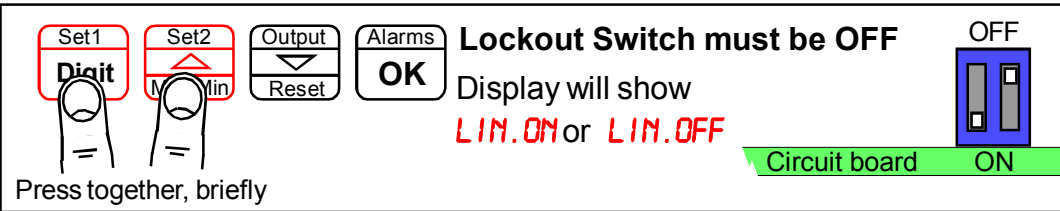

Press together, briefly

**Lockout Switch must be OFF**

Display will show **LIN.ON** or **LIN.OFF**

Circuit board **ON**
- 2**

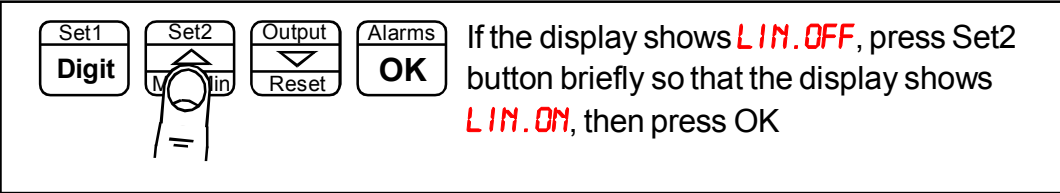

If the display shows **LIN.OFF**, press Set2 button briefly so that the display shows **LIN.ON**, then press OK
- 3**

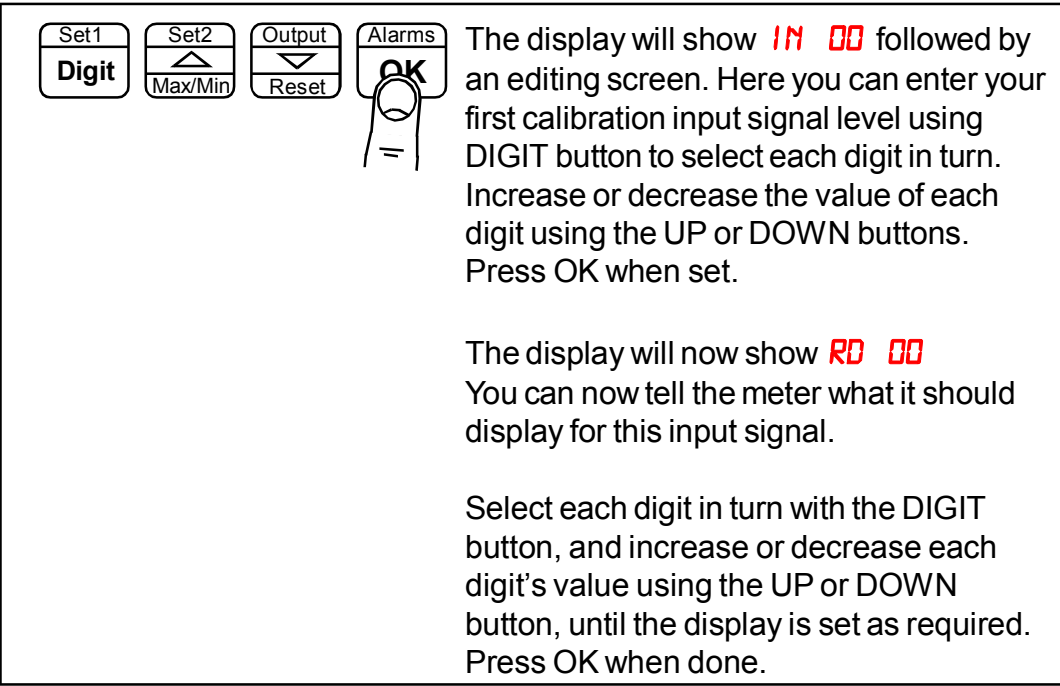

The display will show **IN 00** followed by an editing screen. Here you can enter your first calibration input signal level using DIGIT button to select each digit in turn. Increase or decrease the value of each digit using the UP or DOWN buttons. Press OK when set.

The display will now show **RD 00**  
You can now tell the meter what it should display for this input signal.

Select each digit in turn with the DIGIT button, and increase or decrease each digit's value using the UP or DOWN button, until the display is set as required. Press OK when done.
- 4**



Display will show **ADD.PT**

Press OK

Continued ...

# Linearisation with Theoretical Cal. - cont'd.

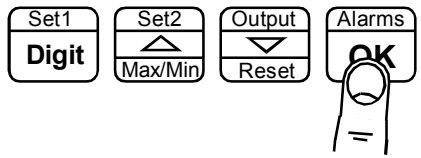

The display will show **IN 01** followed by an editing screen. Here you can enter your next calibration input signal level using DIGIT button to select each digit in turn. Increase or decrease the value of each digit using the UP or DOWN buttons. Press OK when set.

The display will now show **RD 01**  
You can now tell the meter what it should display for this input signal.

Select each digit in turn with the DIGIT button, and increase or decrease each digit's value using the UP or DOWN button, until the display is set as required. Press OK when done.

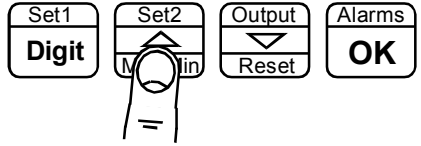
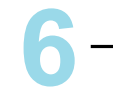

The display will show **ADD.PT**  
Press OK if you want to Add another calibration point, you will repeat the previous steps, each time incrementing **In XX** and **rd XX** up to In 09 and rd 09 which are the last available points.

If you want to finish adding points, press Set2 until the display shows **SAVE**, and then confirm by pressing OK

If you want to abort the setup, press Set2 until the display shows **QUIT** and then press OK

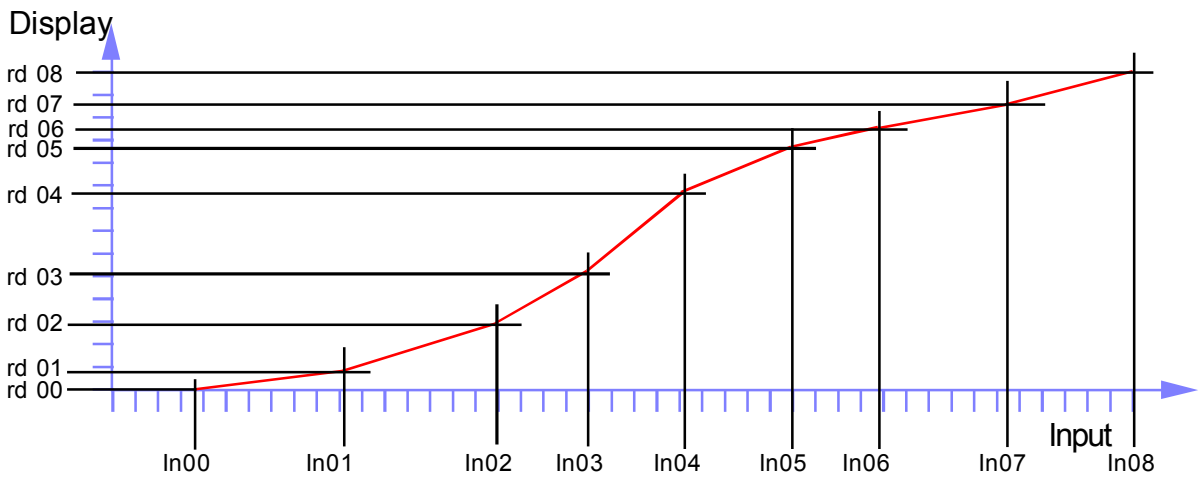
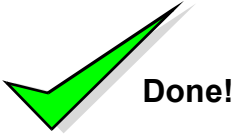

# Sensor Drift correction

If your system is normally reading 0, for example as is typical with platform scales or a torque meter, you may find a small amount of sensor drift caused by changes in temperature, ageing etc.

We can automatically correct for slow, long term drift, by comparing your signal to 0 every 30 seconds, and re-calibrating to remove any detected movement.

This does not affect the sensitivity of your system, and is only applied for readings less than 8 least-significant counts.

The corrected value is stored in non-volatile memory, so that any drift trend will be re-applied after you have switched off the meter.

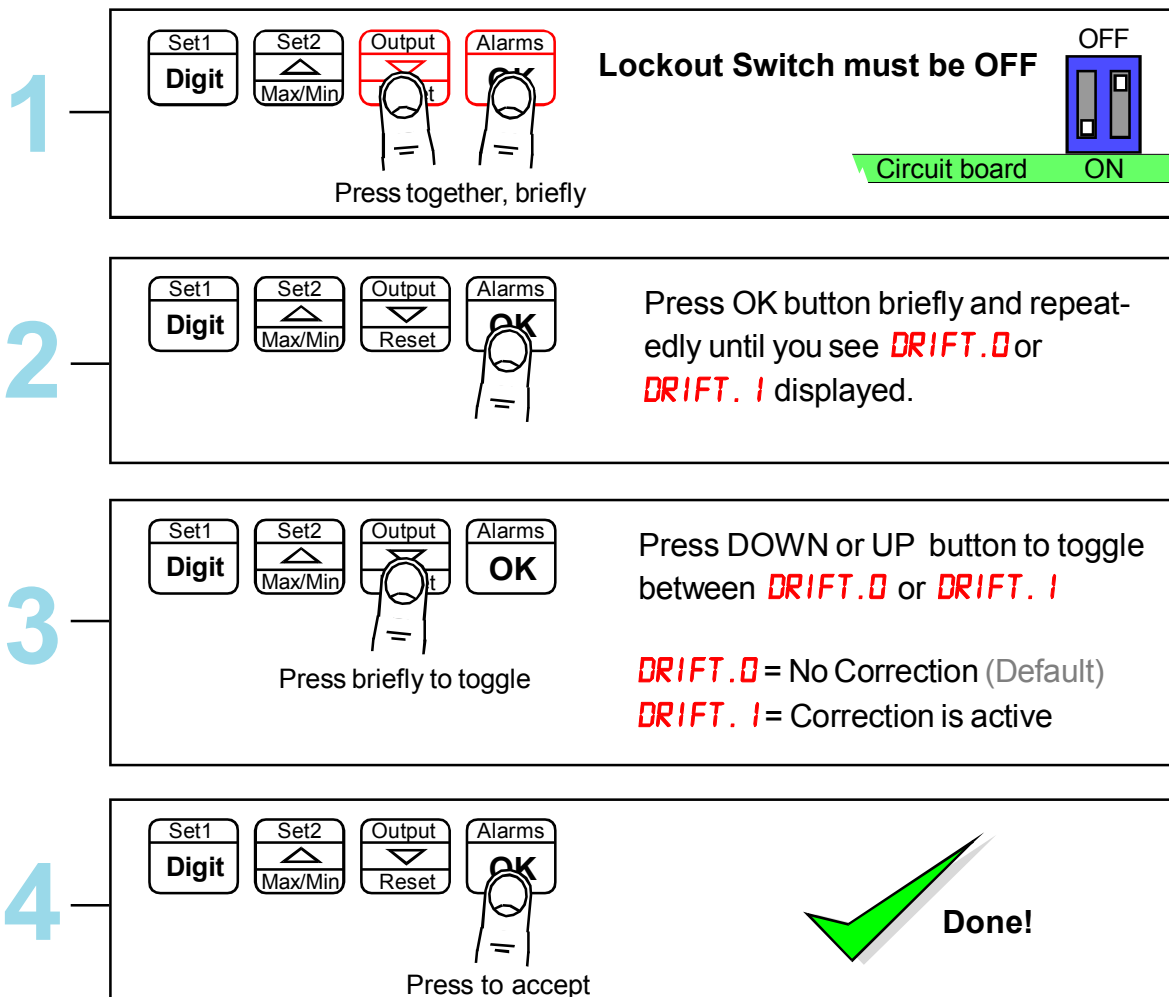



# Logic input functions

The three contact closure inputs on the rear of the meter have default functions which are:-

- Contact closure 1 = Tare
- Contact closure 2 = Peak/Valley display
- Contact closure 3 = Reset

You can re-assign these to include :HOLD, Nett/Gross value display, Memory page address 1,2 or 4 (only if Multi-memory MEM option is installed)

**1**

Set1  
Digit

Set2  
Max/Min

Output  
↓

Alarms  
OK

**Lockout Switch must be OFF**



OFF

Press 3 seconds

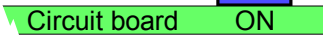

Circuit board ON

**2**

Set1  
Digit

Set2  
Max/Min

Output  
Reset

Alarms  
OK

Press repeatedly until you see **CC. 1**, followed by the existing function for Contact Closure 1.

After you have set **CC. 1**, you will get the prompt **CC. 2** to allow you to set Contact Closure 2 function and when you have set CC.2 you will get the prompt **CC. 3** to allow you to set Contact Closure 3 function

**3**

Set1  
Digit

Set2  
Max/Min

Output  
Reset

Alarms  
OK

Use UP or DOWN buttons to select from these available functions...

Defaults are:-

<b>CC. 1 = TARE</b>	<b>TARE</b> = Tare display to 0
<b>CC. 2 = PV</b>	<b>PV</b> = Peak/Valley toggle
<b>CC. 3 = RST</b>	<b>RST</b> = Reset
	<b>HOLD</b> = Freeze display
	<b>NET.GRO</b> = Nett / Gross display
	<b>PA. 1</b> = Page Address 1*
	<b>PA. 2</b> = Page Address 2*
	<b>PA. 4</b> = Page Address 4*

**4**

Set1  
Digit

Set2  
Max/Min

Output  
Reset

Alarms  
OK



**Done!**

Press to accept

\* Only available if the Multi-memory MEM option is installed

# Logic input connections and front buttons

The previous page explained how to select the functions of the 3 logic inputs. You can connect remote contact closures or open NPN collectors to activate these logic inputs.

The logic input provides a 5V DC signal. When you connect this to common, a current of 1mA will flow. Because this is a small signal, we recommend you use switches with gold plated contacts, or self cleaning contacts, for best long term reliability.

The logic inputs are not galvanically isolated from the input signal.

The logic inputs are only activated when the lockout switch is ON

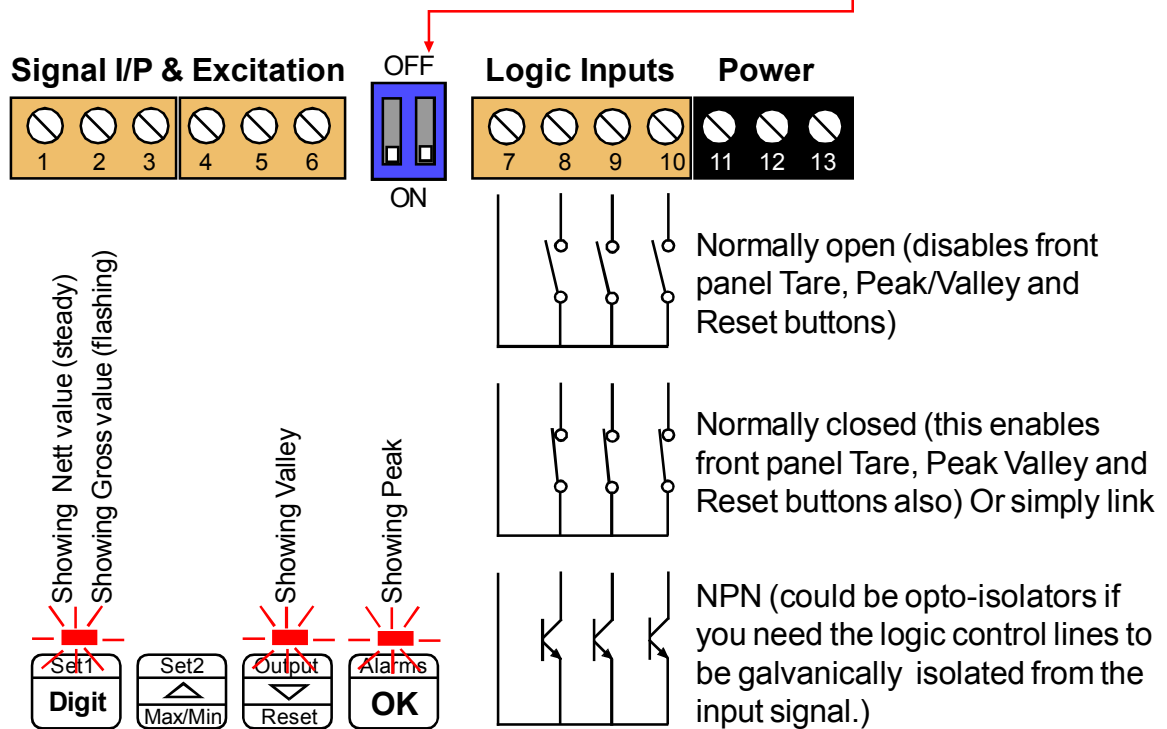

**TARE** = Tares display to 0. Often used in weighing systems to zero a display prior to making a measurement. Net weight is shown once tared. When a display has been tared the small LED above the Set1 button will be illuminated.

**PV** = Peak/Valley toggle. Allows you to view the maximum and minimum values which have been displayed since last reset. 0% LED illuminates when showing valley, 100% LED illuminates when showing peak.

**RST** = Reset. This clears any tare, peak, valley, alarm latch

**HOLD** = Freezes the displayed value for as long as the Hold input is closed

**NET.GRO** = Allows you to toggle between Nett and Gross values on the display

**PA. 1 .. 4** = Page Addresses, if MEM option is installed.

# Factory Defaults

You can return the display to its factory default conditions whenever you wish. If you do so, you will permanently lose all your settings and will need to start from the beginning again.

The calibration Audit Counter will NOT be reset, there is no way provided to reset this value, as it is intended as a secure record to indicate whether changes have been made to the display since it was last calibrated..

**1**

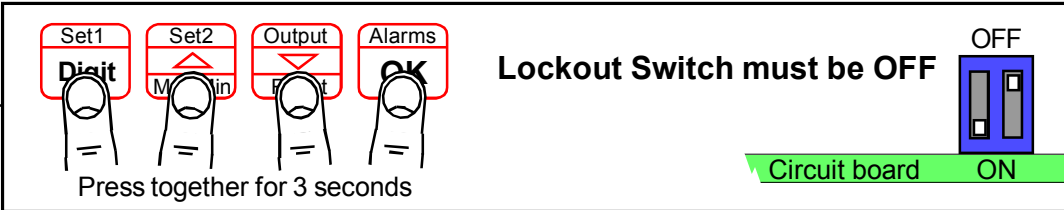

Set1 Digit Set2 Max/Min Output Reset Alarms OK

Press together for 3 seconds

Lockout Switch must be OFF

Circuit board ON

**2**

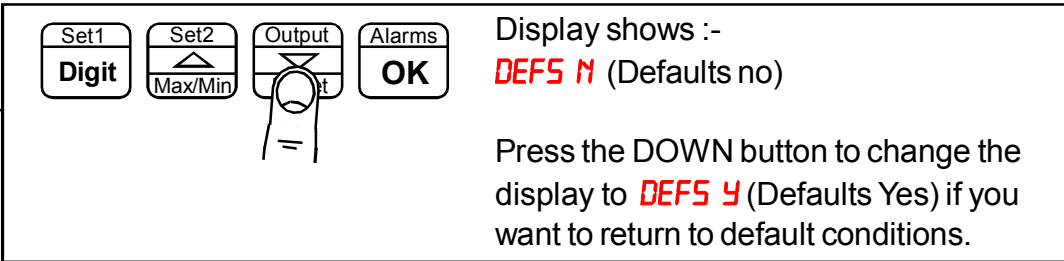

Set1 Digit Set2 Max/Min Output Reset Alarms OK

Display shows :-  
**DEFS N** (Defaults no)

Press the DOWN button to change the display to **DEFS Y** (Defaults Yes) if you want to return to default conditions.

**3**

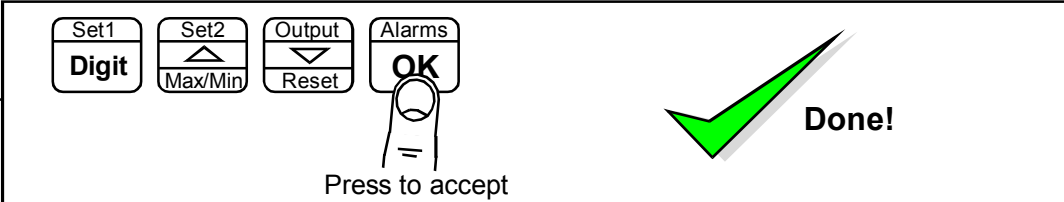

Set1 Digit Set2 Max/Min Output Reset Alarms OK

Press to accept

Done!

## Calibration audit number

Your display includes a non-resettable counter which increments each time you make a change to the display's calibration. This is useful if you want to check whether a display has been altered since it was last calibrated.

The Calibration audit number starts at **CAL 01** up to **CAL FF** allowing up to 255 alterations to be recorded. Whenever you want to check the calibration audit number, press and hold the 2 outer buttons (Set1 + Alarms) for more than 3 seconds.

**1**

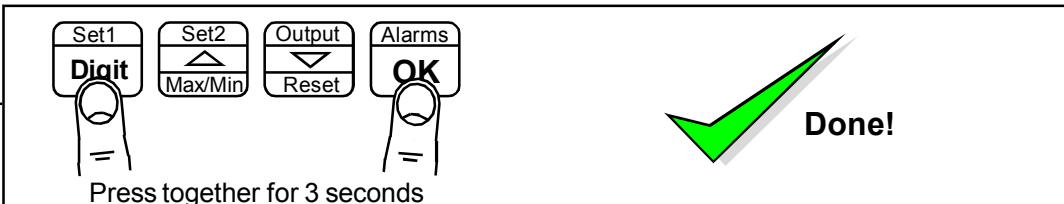

Set1 Digit Set2 Max/Min Output Reset Alarms OK

Press together for 3 seconds

Done!

# Signal Filtering / Averaging

You can adjust the filtering time constant to reduce the effect of noise or instability on your input signal.

A larger FIL value will give a more stable display, but the response to signal changes will be slower.

Because your output options, such as analogue output, alarm relays and serial output are all derived from the displayed value, they will respond at the same rate as the filtered display.

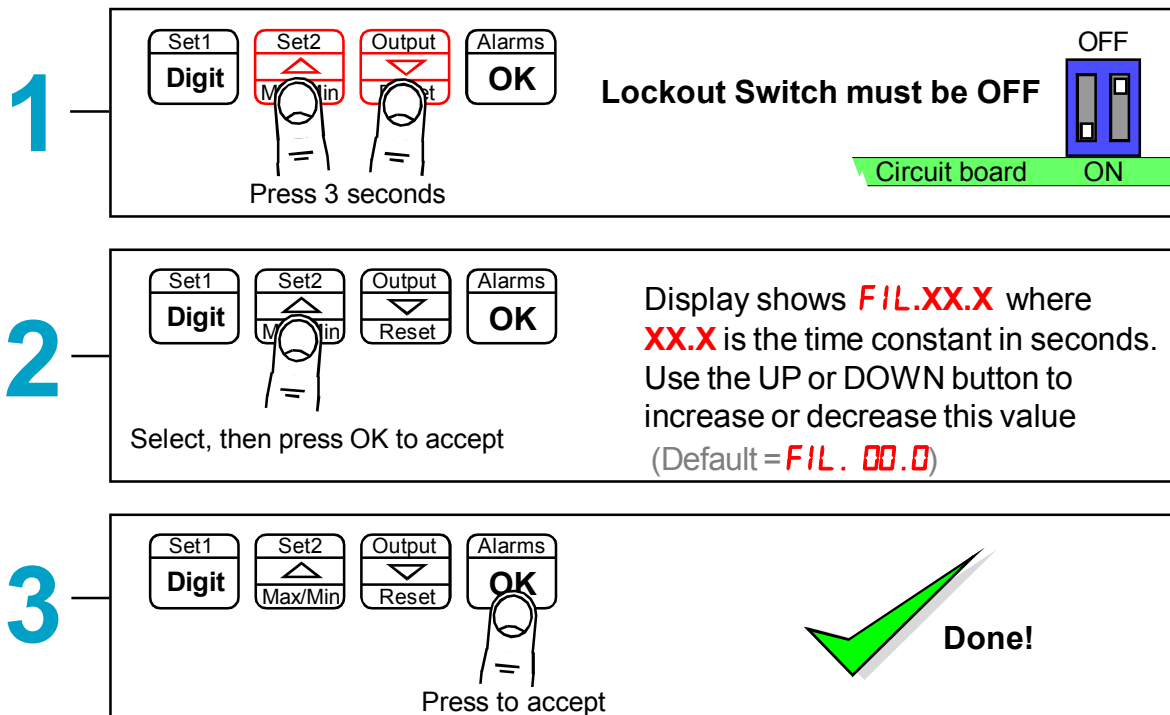

See also Filter Jump setting if your signal is particularly noisy and you cannot get sufficient smoothing with this filter.

This meter also includes an active filter for removing the effects of vibration. It is shipped with the filter enabled for maximum stability. You can move a push-on jumper switch to change the filter response to maximum speed if you wish. See below.

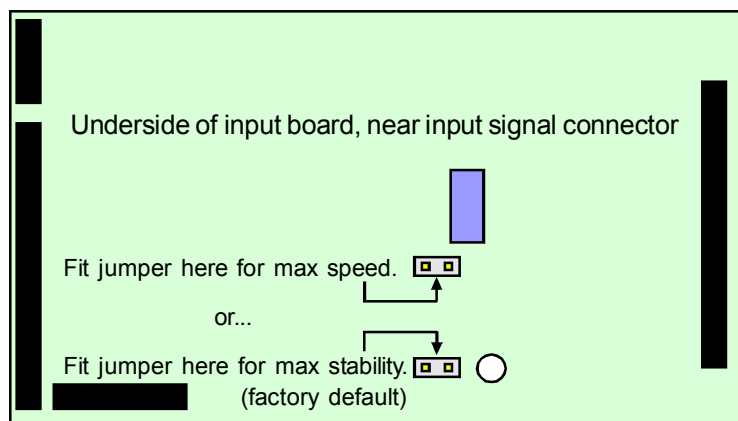

# Filter Jump value

See the Easy/Advanced mode selection page near the beginning of this manual, and choose advanced mode.

The Filter Jump value allows you to decide how the display will respond to a process step change. It does this by overriding the filtering, if the input signal moves by more than a chosen amount in one conversion. The Filter Jump default value is 10%.

This means that for noise amplitude which has a peak value of less than 10% of the input range, filtering will be applied. Any signal movement greater than 10% of the input range will cause the display to jump immediately to that value, without filtering. After that jump, normal filtering will be re-applied, provided signal movement thereafter is less than 10% per conversion.

## Guidance:

For noisy systems, increase the Filter Jump value up to a maximum of 99. Choose a value which gives a good compromise between filtering and response speed.

For reasonably clean signals, a Filter Jump value of around 10 or less will give a good compromise between filtering and response speed to step change inputs.

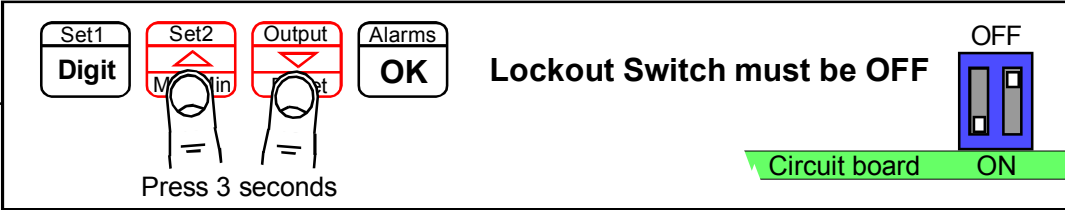
- 

1

Set1 Digit Set2 Max/Min Output Reset Alarms OK

Press 3 seconds

Lockout Switch must be OFF

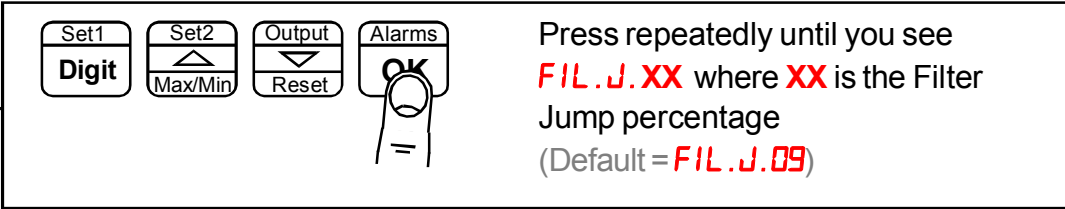
Circuit board ON
- 

2

Set1 Digit Set2 Max/Min Output Reset Alarms OK

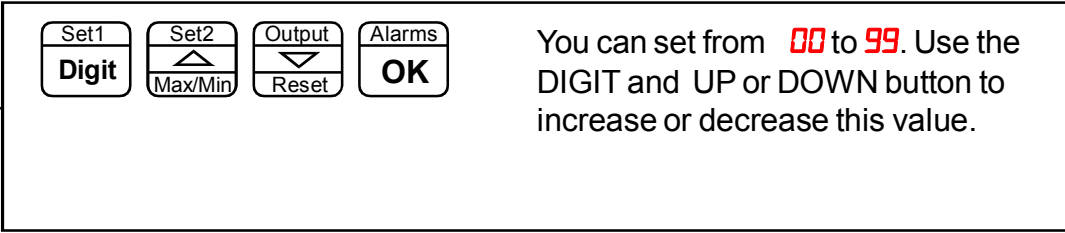
Press repeatedly until you see **FIL.J.XX** where **XX** is the Filter Jump percentage (Default = **FIL.J.09**)
- 

3

Set1 Digit Set2 Max/Min Output Reset Alarms OK

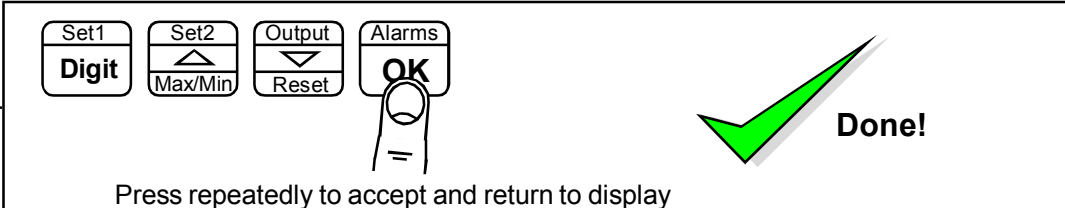
You can set from **00** to **99**. Use the DIGIT and UP or DOWN button to increase or decrease this value.
- 

4

Set1 Digit Set2 Max/Min Output Reset Alarms OK

Press repeatedly to accept and return to display

Done!

# Last Digit rounding up by 1, 2, 5, 10, 20 or 50

You can adjust the way the display rounds up, which is useful if you want to display a very large number, but do not want jitter on the last digit.

The display can be set to round up to the nearest 1 (no rounding) 2, 5, 10, 20 or 50

**1**

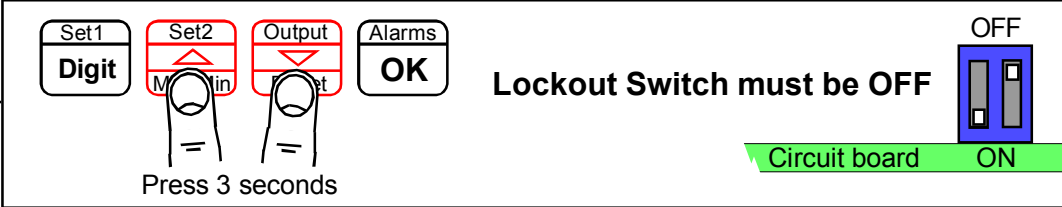

Set1 Digit Set2 Max/Min Output Reset Alarms OK

Press 3 seconds

Lockout Switch must be OFF

Circuit board ON

**2**

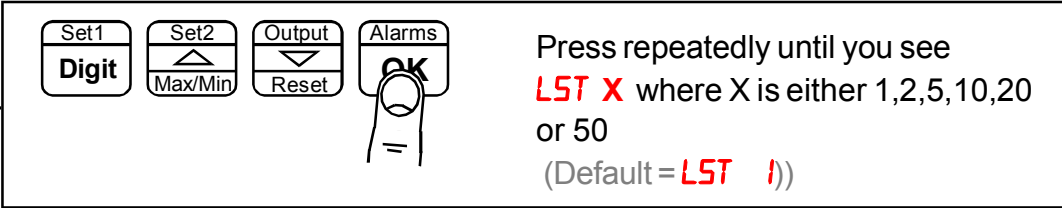

Set1 Digit Set2 Max/Min Output Reset Alarms OK

Press repeatedly until you see **LST X** where X is either 1,2,5,10,20 or 50  
(Default = **LST 1**)

**3**

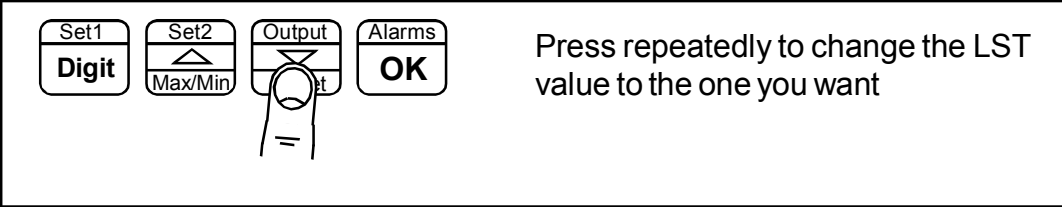

Set1 Digit Set2 Max/Min Output Reset Alarms OK

Press repeatedly to change the LST value to the one you want

**4**

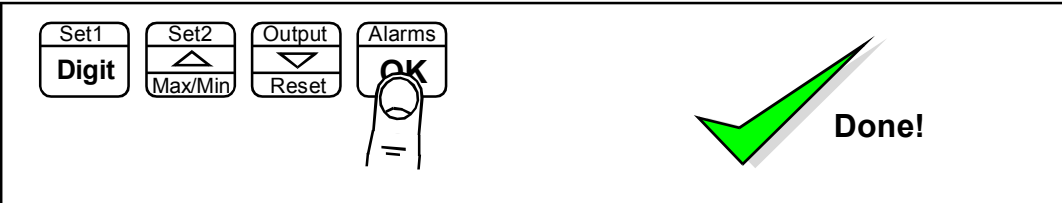

Set1 Digit Set2 Max/Min Output Reset Alarms OK

Done!

# Scale Factor adjustment

After you have calibrated your meter, you can use the SCALE feature to make fine adjustments to calibration, without affecting the calibration itself.

## Examples

### 1. Changing weight units of measure from kg to pounds

You could also use the SCALE to convert your readout from kg to pounds, without affecting the calibration. Simply set SCALE = 2.205 and your meter which was calibrated in kg will now read in pounds.

### 2. Correcting for gravitational variance

Your weighing system was calibrated where gravitational acceleration =  $9.812\text{m/s}^2$  (London) You then move the system to Bangkok where gravitational acceleration is reduced to  $9.782\text{m/s}^2$

You can correct for this difference by setting Scale =  $9.812 / 9.782 = 1.003$ , so that a given mass in Bangkok will show the same weight as it did in London. Set Offset = 0.0000

See [http://en.wikipedia.org/wiki/Earth%27s\\_gravity](http://en.wikipedia.org/wiki/Earth%27s_gravity)

- 1

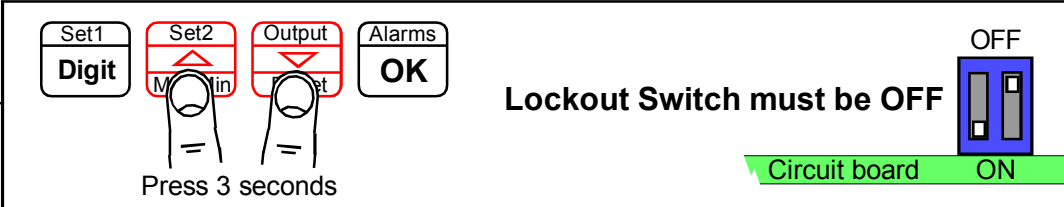

Set1 Digit Set2 Max/Min Output Reset Alarms OK

Press 3 seconds

Lockout Switch must be OFF

Circuit board ON
- 2

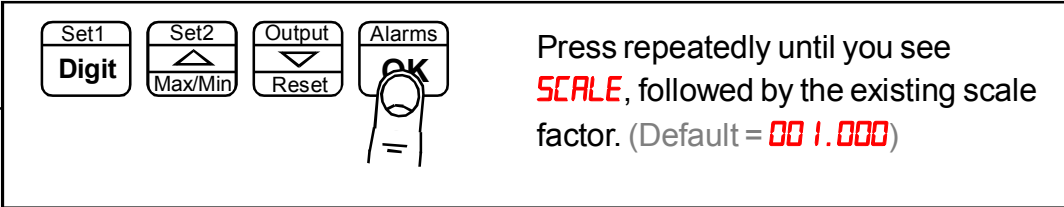

Set1 Digit Set2 Max/Min Output Reset Alarms OK

Press repeatedly until you see **SCALE**, followed by the existing scale factor. (Default = **001.000**)
- 3

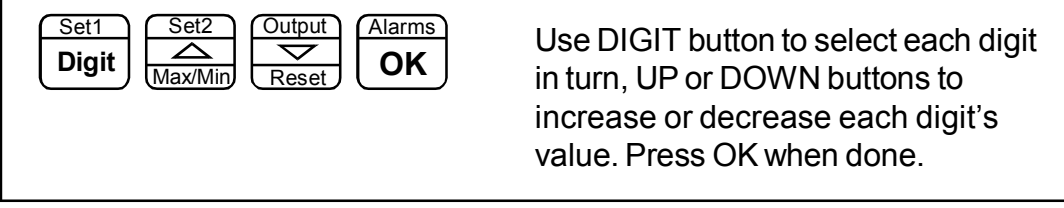

Set1 Digit Set2 Max/Min Output Reset Alarms OK

Use DIGIT button to select each digit in turn, UP or DOWN buttons to increase or decrease each digit's value. Press OK when done.
- 4

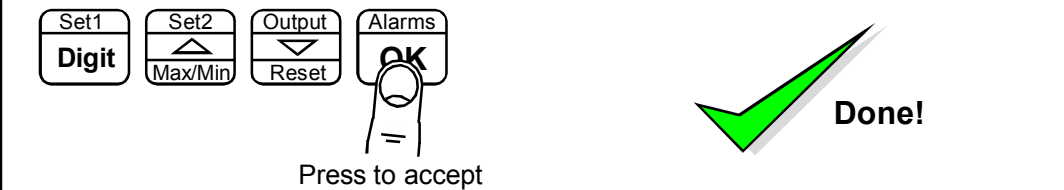

Set1 Digit Set2 Max/Min Output Reset Alarms OK

Press to accept

Done!

You may want to adjust an offset value also, see separate OFFSET page for this feature.

# Offset adjustment

After you have calibrated your meter, you can use the **OFFSET** feature to make fine additions or subtractions to the reading, without affecting the calibration itself.

For example if your weighing structure is altered after calibration and you want to subtract the effect of 37kg of extra metalwork which was welded to the hopper, you can easily do this by entering a value of -37 in the offset value.

**1**

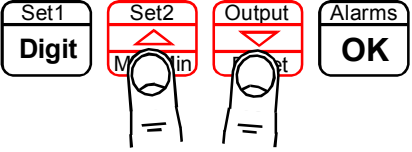

Set1 Digit Set2 Max/Min Output Reset Alarms OK

Press 3 seconds

Lockout Switch must be OFF

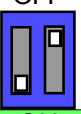

Circuit board ON

**2**

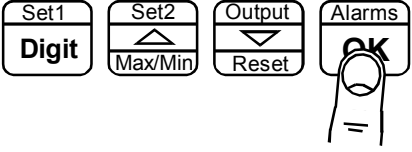

Set1 Digit Set2 Max/Min Output Reset Alarms OK

Press repeatedly until you see **OFFSET**, followed by the existing offset value. (Default is **000.000**)

**3**

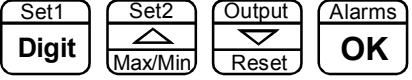

Set1 Digit Set2 Max/Min Output Reset Alarms OK

Use DIGIT button to select each digit in turn, UP or DOWN buttons to increase or decrease each digit's value. If you want to set a negative value, use DIGIT to select the left hand digit, and press the down button to go below 0 to activate the - sign. Press OK when done.

**4**



Set1 Digit Set2 Max/Min Output Reset Alarms OK

Press to accept



Done!

You may want to adjust a SCALE FACTOR value also, without affecting calibration. See the separate SCALE page for this feature.



# Menu timeout adjustment

The display has a default timeout of 60 seconds, to allow you sufficient time to refer to the manual between key operations.

You can make this period shorter, if you wish, once you become more familiar with the setup method.

**1**

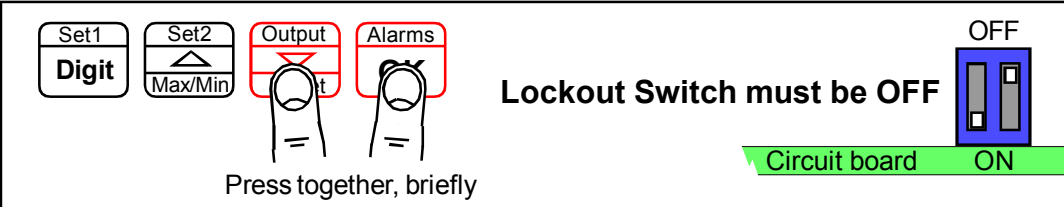

Set1 Digit Set2 Max/Min Output Alarms

Press together, briefly

Lockout Switch must be OFF

Circuit board ON

**2**

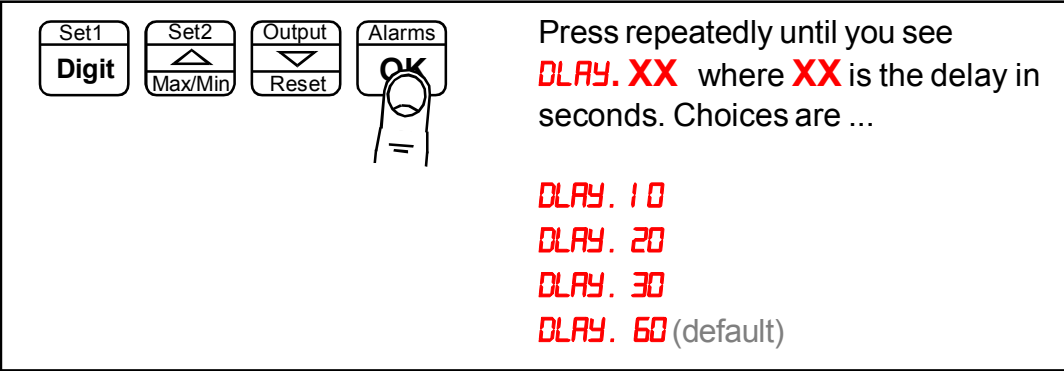

Set1 Digit Set2 Max/Min Output Reset Alarms OK

Press repeatedly until you see **DLAY. XX** where **XX** is the delay in seconds. Choices are ...

**DLAY. 10**  
**DLAY. 20**  
**DLAY. 30**  
**DLAY. 60** (default)

**3**

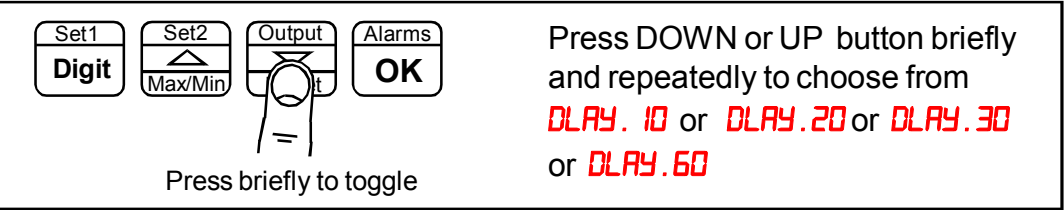

Set1 Digit Set2 Max/Min Output Reset Alarms OK

Press DOWN or UP button briefly and repeatedly to choose from **DLAY. 10** or **DLAY. 20** or **DLAY. 30** or **DLAY. 60**

Press briefly to toggle

**4**

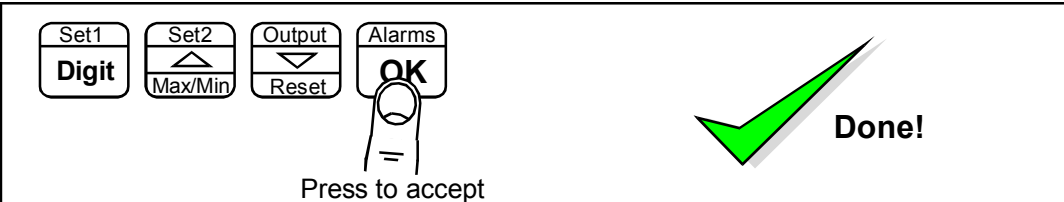

Set1 Digit Set2 Max/Min Output Reset Alarms OK

Press to accept

Done!

# Reverse Display function (mirror image)

If you need to be able to see a reflection of the display in a mirror or other reflective surface, for example in a simple heads-up system, or for drivers reversing into a bay, using mirrors only, you can set the display to show as a mirror image.

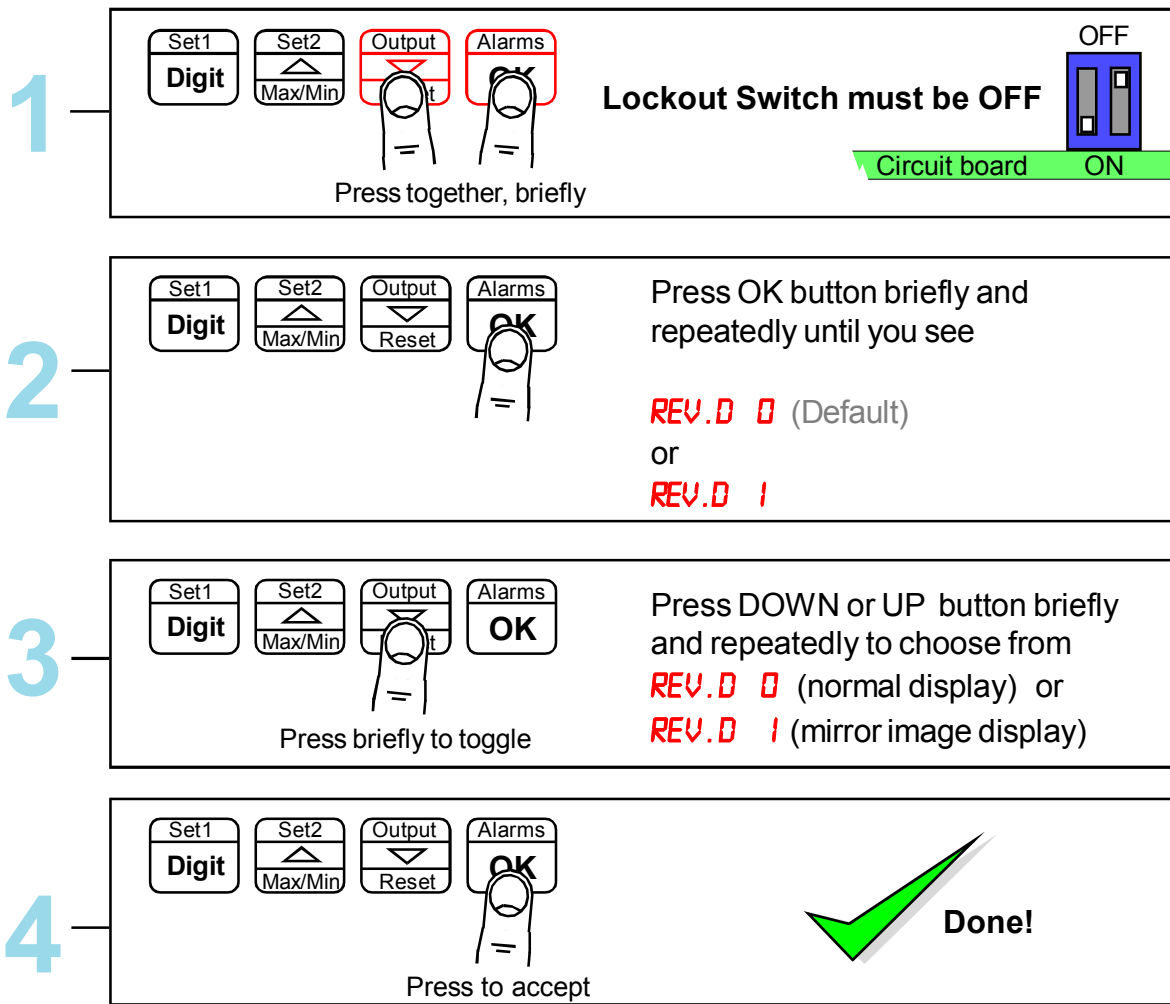

REV.D 0



Example of normal display format displaying the number 876543

REV.D 1



Example of Mirror Reverse display format displaying the number 876543

# Bootup routine choices

When you switch on your meter, it can be set to power up with 3 possible summary message combinations.

The choices are:-

- BOOT 0** = Segment test, followed by a full summary of software revision, calibration audit number, model number, installed options.
- BOOT 1** = Segment test followed by model number (Default)
- BOOT 2** = No summary, meter displays the measurement value immediately power is applied.
- BOOT 3** = Segment test remains permanently active until a button is pressed.

**1**

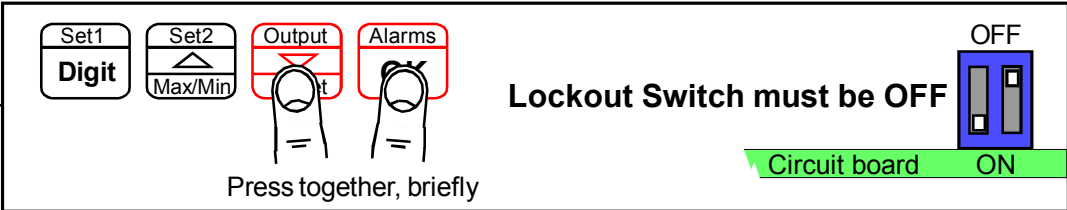

Set1 Digit   Set2 Max/Min   Output   Alarms OK

Press together, briefly

Lockout Switch must be OFF

Circuit board ON OFF

**2**

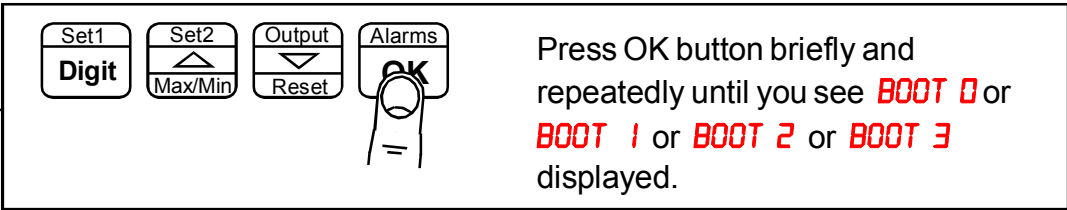

Set1 Digit   Set2 Max/Min   Output Reset   Alarms OK

Press OK button briefly and repeatedly until you see **BOOT 0** or **BOOT 1** or **BOOT 2** or **BOOT 3** displayed.

**3**

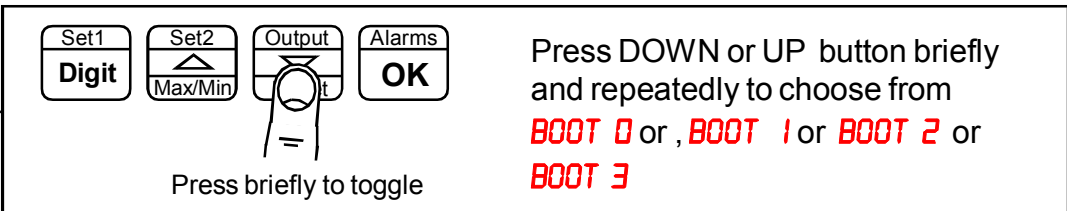

Set1 Digit   Set2 Max/Min   Output   Alarms OK

Press briefly to toggle

Press DOWN or UP button briefly and repeatedly to choose from **BOOT 0** or **BOOT 1** or **BOOT 2** or **BOOT 3**

**4**

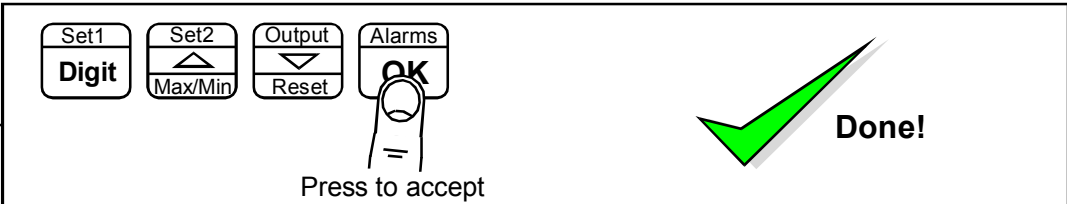

Set1 Digit   Set2 Max/Min   Output Reset   Alarms OK

Press to accept

Done!



You can trigger the full summary message whenever you want, without having to power the meter off, by pressing and holding the 2 outer buttons (Set1 + Alarms) for more than 3 seconds.

# Multi-Program Memory option MEM

The three contact closure inputs on the rear of the meter may be used to call up between 1 to 7 additional meter setup memories (pages), if the MEM option has been installed. This allows you to save up to 8 complete sets of independent calibrations, alarm settings, analogue output settings and serial comms settings.

First decide how many memory pages you want, as this will determine how many logic inputs you will need to use for the addressing. Logic inputs not required for Page Addressing can be used for other functions such as Tare, Reset, Display Hold, Peak/Valley display.

If you have used all 3 logic inputs for Page Addressing, you can still use the meter's front panel buttons to perform Tare, Reset and peak/Valley view.

**See "Contact Closure Input Functions" page for CC.1, CC.2, CC.3 and COP settings**

Total number of pages	Logic Inputs required for addressing
1	none, standard single page meter
2	1 Set CC.1 = PA.1
3 or 4	2 Set CC.1 = PA.1, Set CC.2 = PA.2
5 to 8	3 Set CC.1 = PA.1, Set CC.2 = PA.2, Set CC.3 = PA.4

1. Set lockout switches OFF, and set page address to 0 or unplug the logic connector.
2. Set the copy instruction to **COP. 1** in page address 0 ( found after you set CC3) .
3. Press all 4 buttons together, display shows **DEFS. N**
4. Press the Up arrow to change display to **DEFS. 4** and press OK.
5. If you want all channels to share a common setting, eg calibration, do that setting now.
6. When you want to do separate settings for each channel, set COP.0

## Programming and recalling individual pages

Plug the logic input connector back in, if you removed it earlier. Select a page address using the switch combinations shown below, wired to the Logic Input connector ...

Page address 0	All logic inputs open
Page address 1	CC.1 closed to Common
Page address 2	CC.2 closed to Common
Page address 3	CC.1 and CC.2 closed to Common
Page address 4	CC.4 closed to Common
Page address 5	CC.1 and CC.3 closed to Common
Page address 6	CC.2 and CC.3 closed to Common
Page address 7	All logic inputs closed to Common

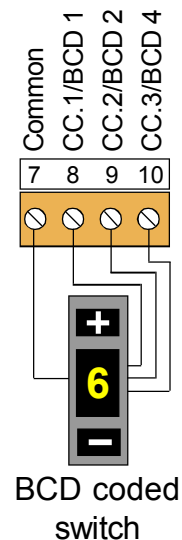

Perform the settings you require, according to the pages in this manual. Do this for all page addresses required. Then put the lockout switch in its ON position. Now, if you select a page address, the meter will briefly confirm the chosen page address on screen, and will then function according to the settings you programmed for that address.

Suitable BCD coded switches are available from many electrical supply stores. For example consider Kraus & Naimer part A540-600 E24 or Apem part number IRBC10N1248 or London Electronics part number SW2P-8W-BCD, which also provides separate 2 pole 8 way signal selection function.

# Error codes and fault finding



1. Under Range. The meter is being asked to display a value which is more negative than its limit of -199999



2. Over Range. The meter is being asked to display a value which is higher than its limit of 999999

These fault codes could be displayed because the signal is too negative, too positive, or because there is a wiring error, or because the display's scaling has been adjusted to give excessive sensitivity, or because there is a fault in the display.

a. If you are connecting a 4-20mA signal to the display, please measure the DC millivolt signal between terminals 2(-) and 3(+) Ideally, you will measure 132mV at 4mA and 660mV at 20mA.

If the voltage is much higher, there may be a problem with the 33 Ohm input shunt resistor.

You can verify this as follows...

Remove the input signal and power connectors to the meter, and measure the resistance between terminals 2 and 3. This should be 33 Ohms. If it is more than this, the resistor has probably been overloaded and burned by having a voltage connected across it. Please check your field wiring to ensure that no more than 30mA or 1V can be applied to the current input terminals.

Sometimes excessive current can feed to the current input of the display if your 2 wire 4-20mA transmitter is faulty or is wired incorrectly, because we rely on the transmitter to regulate the loop current between 4 and 20mA. The excitation power supply for the loop may have a much higher capacity than 20mA.

b. If the measurements above were satisfactory, the problem may be caused by the scaling being too sensitive.

If you are happy to do so, it is a simple matter to reset the display's scaling to the factory default conditions. Put the lockout switch off and press all 4 buttons together for around 3 seconds until the display shows "dEFS n". Then press the UP button once so the display shows "dEFS Y". Now press the OK button and the display will be reset to factory defaults.

If still no success, please return the display to us for the attention of our QA Manager, with a report of what you found, for repair.

# How to install option boards



Where the product is intended for "UL" installations removal or addition of option boards is not permitted.



**Warning:** Disconnect power before you expose the rear of the meter

If you want to open your meter to install or modify option boards, follow these steps...

- 1) Switch off power to the meter and unplug all connectors.
- 2) Remove the 4 small screws shown in the diagram.
- 4) Slide the electronic boards out through the rear of the case. The upper option board plugs into a female socket on the main board. It is held securely in place with two option supports, which have a grooved slot, into which the board sits.

To add or remove an option board, you must release the screws holding the option supports, so that the option board can be plugged into the socket. Then tighten the option supports to clamp the option board firmly in place.

The board assemblies will look something like this...

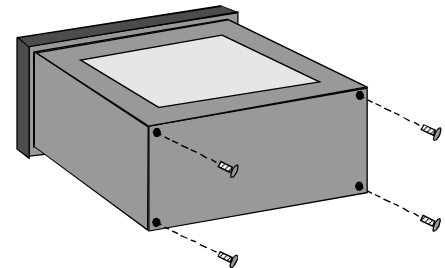
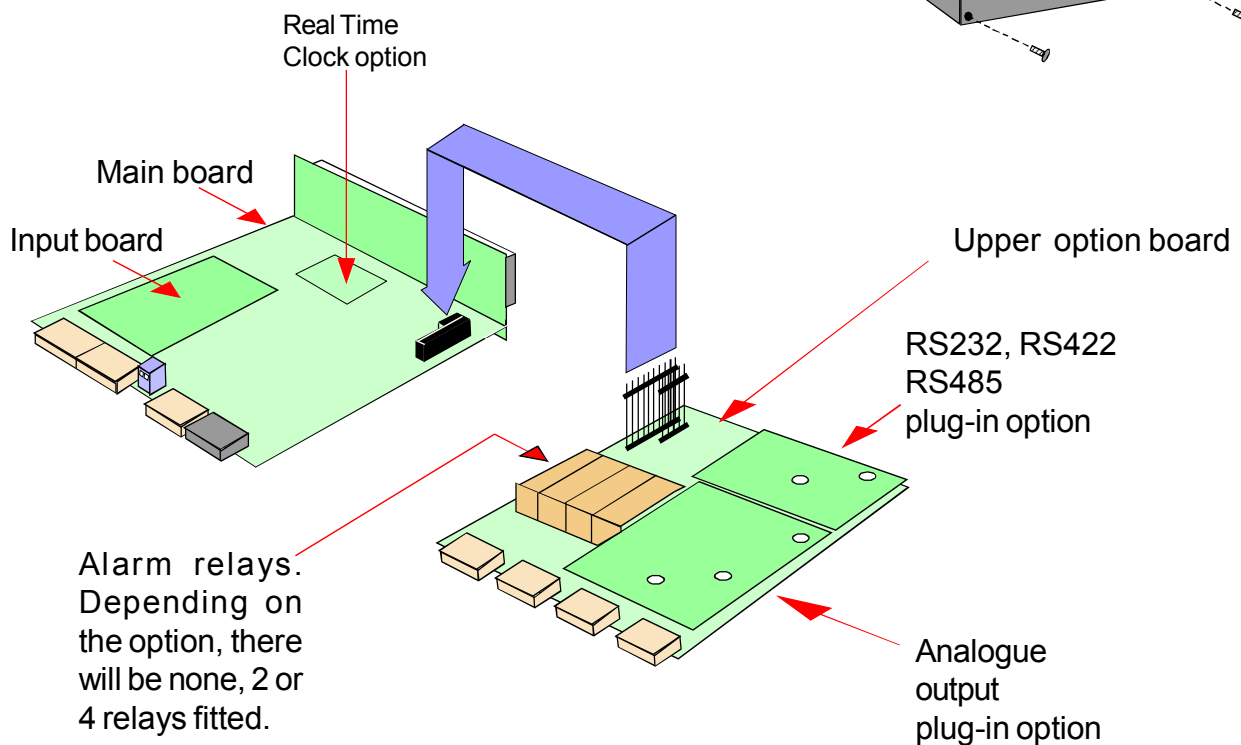

The analogue output and RS232 or RS422 plug-in option boards are fixed to the upper option board with white plastic pillars. You must apply a firm force when fitting or removing these options.

Always be careful to connect the pins to sockets accurately.

# Waste Electrical Electronic Equipment (WEEE)

In Europe, this equipment must be disposed of in accordance with European Parliamentary Directive 2002/96/EC

This directive encourages recycling and the reduction of waste materials in the environment.

This means it must be sent to an approved recycling plant if you want to dispose of it.

It must not be thrown away with general rubbish.



# WEEE Waste Recycling

If you are unable to dispose of this item locally, you may send it to us for recycling.

## Conditions:

1. We will only accept items of our manufacture.
2. You must pay for the transport of the goods to us.
3. We will only accept items if they include a signed declaration by an authorised person in your organisation, stating that :-
  - i. The item is safe to handle and has no contaminants which may be harmful to health.
  - ii. You wish us to dispose of or destroy the item(s)

# Equipment Specifications

<b>Bezel size</b>	72mm high by 144 mm wide
<b>Panel Cutout</b>	67.5 mm high by 138 mm wide
<b>Case Depth</b>	150 mm including connectors
<b>Weight</b>	450 grammes
<b>Case Material</b>	Black polycarbonate
<b>Connectors</b>	Detachable Screw Terminal connectors
<b>Environmental</b>	Storage Temperature range -20 to +70C, non condensing Operating temperature range 0 to 50C, non condensing Front sealed IP65 if SPC4-M cover fitted. Please allow 30 minutes for unit to achieve thermal equilibrium.
<b>Power Burden</b>	100-240 VAC, 45 to 60Hz or 11-30 VDC optional 10VA maximum
<b>Input Signals (bipolar)</b>	0-10V, 0-5V, 1-5V, 0-10mA, 0-20mA, 4-20mA
<b>Input Resistance</b>	1 Megohm for voltage, 33 Ohms for current inputs
<b>Accuracy</b>	+/-0.05% of range
<b>Span tempco</b>	25 ppm/Degree Celsius
<b>Zero Tempco</b>	30 ppm/Degree Celsius
<b>24V Excitation voltage</b>	24VDC nominal rated at 60mA
<b>10V Excitation voltage</b>	10VDC nominal rated at 20mA
<b>Filtering / smoothing</b>	Selectable time constants of 0 to 25 seconds.
<b>A/D conversion</b>	Sigma-Delta 10 conversions per second, 50/60Hz rejection Resolution 1 in 400 000 max. over full range
<b>Display update rate</b>	10 readings per second.
<b>Display Range (max)</b>	-199999 to +999999, depending on available signal level.
<b>Plug-In Output Options</b>	
<b>Analogue O/P</b>	
<b>Alarm Relay O/P</b>	
<b>ASCII Data O/P</b>	
<b>Calendar/Clock option</b>	Manuals Available from our website



# Record of Revisions

6 September 2010	Version F00.18 Software released. Manual format revised to improve clarity and segregate easy from advanced menu functions. Optional outputs now described in their own dedicated manuals. DIN Rail mounting option added. Cabling guidance added.
17 November 2010	Version F00.19 Software released. Intended for use with 9122-2470 input board, having switched capacitor input filter feature. Code will auto detect this board. If a previous version board is installed, the meter will skip switched capacitor filter section of menu.  The newly released 9122-2470 input board allows selection of 5V or 10V excitation.
26 November 2010	Version F00.20 Software released. Allows serial data output to be derived from Net or Gross measurement.
14 February 2011	Version F00.21 software released. Corrected bug to 100mS display update in totalise mode. Corrected bug to MEM option when picking up alarm values on page load. Added bootup mode to illuminate all segments and clear on next button press.
28 February 2011	Warranty increased to 3 years and terms added.
16 May 2017	F.04 software version released
20 September 2022	UKCA certification added

# Notes



We design and manufacture a wide range of standard and custom monitoring and control equipment.

All our UK manufactured products have a 3 year warranty.

**Real-Time Production-Line Displays**

**Large Digital Displays sealed IP65**



**Digital Panel Meters**

**Power Monitors**

**Bargraph Displays**



**Message Displays sealed IP65**

**Signal Transmitters / Isolators**

