

London Electronics Limited

Thorncote Road, Near Sandy, Bedfordshire SG19 1PU
Tel +44(0)1767 626444 Fax +44(0)1767 626446
www.london-electronics.com help@london-electronics.com

Large digit clock / timer Fusion-H 6 digit version

Connection details, scaling and general information

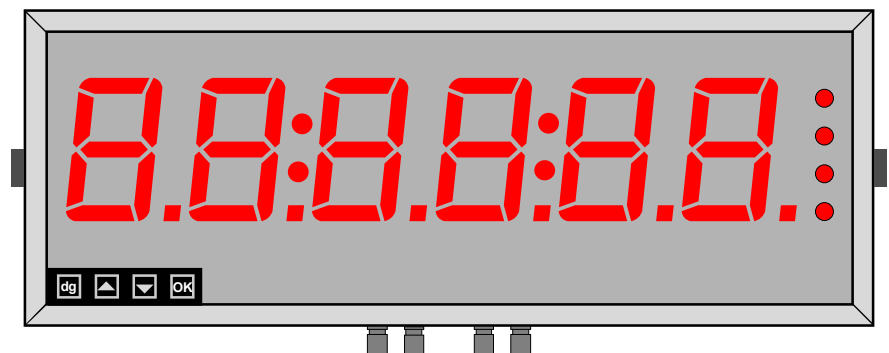

Caution: There is a risk of electrical shock if this instrument is not properly installed



Caution: Risk of danger: Read the whole manual before you install this display

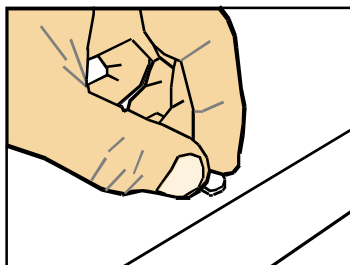

Rear case screws - please note

The rear panel is held in place with finger-screws, which only need to be gently tightened.

Do not use tools to tighten or loosen the screws, as this could cause damage to the internal threads.

Software version H00.33

Document Ref:pm65\manuals\ Revision:23 Dated: 6 August 2021

Warranty

We warrant our products against defects in materials or workmanship for a period of three (3) years from the date of purchase.

In the event of a defect during the warranty period, the unit should be returned, freight (and all duties and taxes) prepaid by the Buyer to the authorised distributor from where the unit was purchased.

The Distributor, at its option, will repair or replace the defective unit. The unit will be returned to the Buyer with freight charges prepaid by the distributor.

LIMITATION OF WARRANTY

The foregoing warranty shall not apply to defects resulting from:

1. Improper or inadequate maintenance by the buyer.
2. Unauthorised modification or misuse.
3. Operation outside the environmental specification of the product.
4. Mishandling or abuse.

The warranty set forth above is exclusive and no other warranty, whether written or oral is expressed or implied. We specifically disclaim the implied warranties of merchantability and fitness for a particular purpose.

EXCLUSIVE REMEDIES

The remedies provided herein are the buyer's sole and exclusive remedies.

In no event shall we be liable for direct, indirect, incidental or consequential damages (including loss of profits) whether based on contract, tort or any other legal theory.

Contents

Warranty	2
Warnings	4
Introduction	5
General Description	6
Suspension Mounting	7
Wall Mounting	8
Panel Mounting	9
Connections	10-11
Installation hints for best performance	12-13
Easy/Advanced menu mode	14
Display Brightness	15
Mode Setting	16
Clock Mode settings	17
Timer Mode settings	18
RTC setup method	19
Factory defaults	20
Calibration audit number	20
Logic input functions	21
Logic Input connections and front buttons	22
Menu Timeout adjustment	23
Reverse / Mirror display setting	24
Bootup Routine choices	25
Language selection for user interface	26
Error Codes	27
Output Options - installing	28
WEEE	29
Equipment Specifications	30
Record of Revisions	31
Declaration of Conformity	32

Separate manuals for options

Alarm option settings	See Alarm manual *
Analogue output option settings	See Analogue manual *
Serial output option settings	See Serial manual *
Real Time Clock setting	See Serial manual *

* Need a manual urgently?

You can download manuals from our website.

Warnings

Please carefully read this manual and all warnings. Install the display ONLY when you are sure that you've covered all aspects.



Where the product is intended for "UL" installations, removal or addition of option boards is not permitted.



Check that the model number and supply voltage suit your application before you install the display.



Connect the display according to current IEE regulations, IEC61010 & NFPA:70 National Electric Code in USA.



Power supplies to this equipment must have anti-surge (T) fuses rated at 1A for 230V supply, 2A for 110V supply, 5A for 48VAC supply or 10A for 11-30VDC.



Don't touch any circuitry after you have connected the display, because there may be lethal voltages on the circuit board.



Do not apply power to the display if its case is open.



Only adjust on-board switches or connections with the power turned off



Make sure all screw terminals are tight before you switch the meter on.



Only clean the display's case and window with a soft damp cloth. Only lightly dampen with water. Do not use any other solvents.

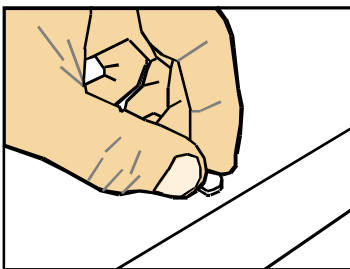

Rear case screws - please note

The rear panel is held in place with finger-screws, which only need to be gently tightened.

Do not use tools to tighten or loosen the screws, as this could cause damage to the internal threads.

**Safety FirstDon't assume anything..... Always double check.
If in doubt, ask someone who is QUALIFIED to assist you in the subject.**

Introduction

Please contact us if you need help, if you have a complaint, or if you have suggestions to help us improve our products or services.

If you contact us about a product you already have, please tell us the full model number and serial number, so that we can give you accurate and fast help.

This product has a 3 year warranty. We will put right or replace any display which is faulty because of bad workmanship or materials. This warranty does not cover damage caused by misuse or accident.

If you return a unit for repair, please include a detailed description of the problem, and the name of a contact who we can refer to for any questions. Please mark for the attention of the QA Department.

IMPORTANT

If this equipment is important to your process, you may want to buy a spare to cover possible failure or accidental damage in the future.

This is because during factory shutdown periods, you may have to wait several weeks for an equivalent replacement, or we may have no stock at the time you urgently need it.

You may also need to pay extra carriage charges if you want a fast, guaranteed courier service. Warranty repairs or replacements are usually returned with a standard courier service.

We do not offer compensation for losses caused by failure of this instrument.

If you do not agree with these conditions, please return this item in unused condition, in its original packaging and we will refund the purchase price, excluding any carriage paid.

We thought you'd prefer to know about possible delays and extra charges now, rather than during a panic. A spare unit could help to avoid these issues.

We always try to improve our products and services, so these may change over time. You should keep this manual safely, because future manuals, for new designs, may not describe this product accurately.

We believe these instructions are accurate, and that we have competently designed and manufactured the product, but please let us know if you find any errors.

General Description

This series of displays accepts industrial sensors to allow various physical measurements to be made, such as weight, temperature, pressure, humidity etc. Different models are available for different sensor types.

The main function of this series is to give a clear numeric readout of the variable being monitored. Most models include an excitation power output, to power the sensor directly.

Various digit heights are available, to suit the maximum viewing distance required in each installation. For every 10 metres of viewing distance required, use 1" of digit height.

Various optional output modules are also available to give alarm relay outputs, analogue output or digital communications, or any combination of these options.

Displays are programmed using front panel pushbuttons. The front panel buttons can be disabled. In addition, you can connect 4 remote wired pushbuttons to the display, so that you can make adjustments while the display is mounted in an inaccessible location.

Power supply options : 100-240 VAC, 48 VAC or 11-30VDC

These displays must be installed fully assembled, and must be installed according to local electrical installation rules.

When properly installed, and provided they have been ordered with cable glands exiting the lower surface of the case, they provide ingress protection to IP65 / NEMA4X from all directions.

Safety



Caution: There is a risk of electrical shock if this display is not properly installed



Caution: Risk of danger: Read the whole manual before you install this display

Obey all safety warnings in this manual, and install the display according to local wiring and installation regulations. Failure to follow these guidelines may cause damage to the display, connected equipment, or may be harmful to personnel.

Any moving mechanical device controlled by this equipment must have suitable access guards to prevent injury to personnel if the display should fail.

Suspension Mounting dimensions

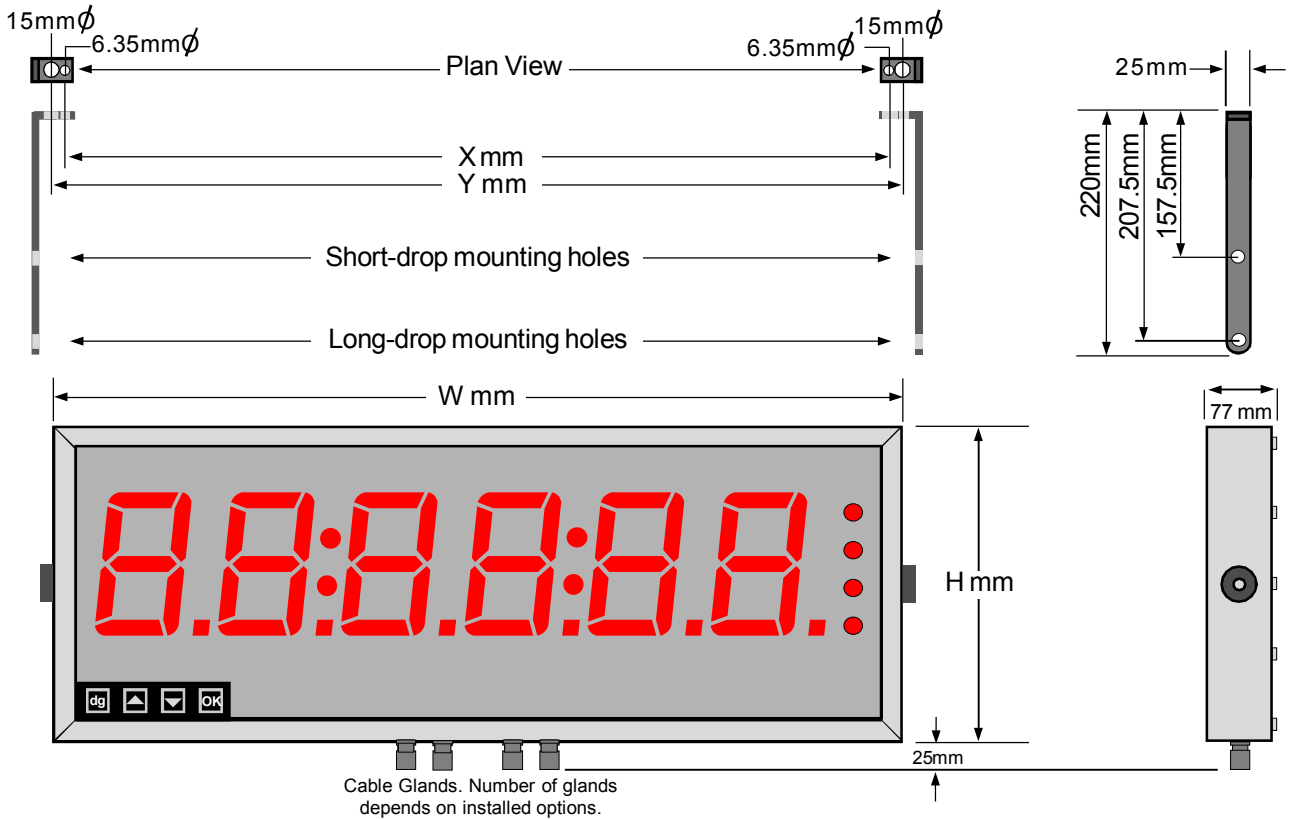

Detail showing bracket hardware fitting sequence

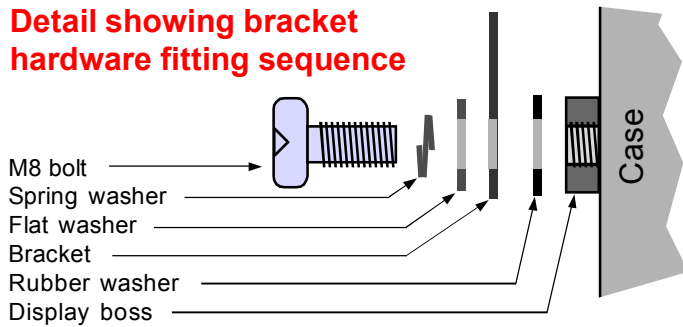

You can order these displays with the cable glands in the bottom surface (as shown) the rear, or top.

Rear glands allow you to mount the display on top of a cubicle, using the brackets shown.

Display Format	X mm	H mm	W mm	Y mm
2" 4 digit clock	245	154.5	291	275
2" 4 digit numeric	233.5	154.5	279.5	263.5
2" 6 digit clock	354	154.5	400	384
2" 6 digit numeric	330	154.5	376	360
4" 4 digit clock	407	195.5	453	437
4" 4 digit numeric	388	195.5	434	418
4" 6 digit clock	607	195.5	653	637
4" 6 digit numeric	570	195.5	616	600
6" 4 digit	534	246	580	564
6" 6 digit	774	246	820	804
8" 4 digit	704	290	750	734
8" 6 digit	1026	290	1072	1056
12" 4 digit	1004	408	1050	1034
12" 6 digit	1494	408	1540	1524
16" 4 digit	1322	515	1368	1352
16" 6 digit	1974	515	2020	2004

Wall Mounting dimensions

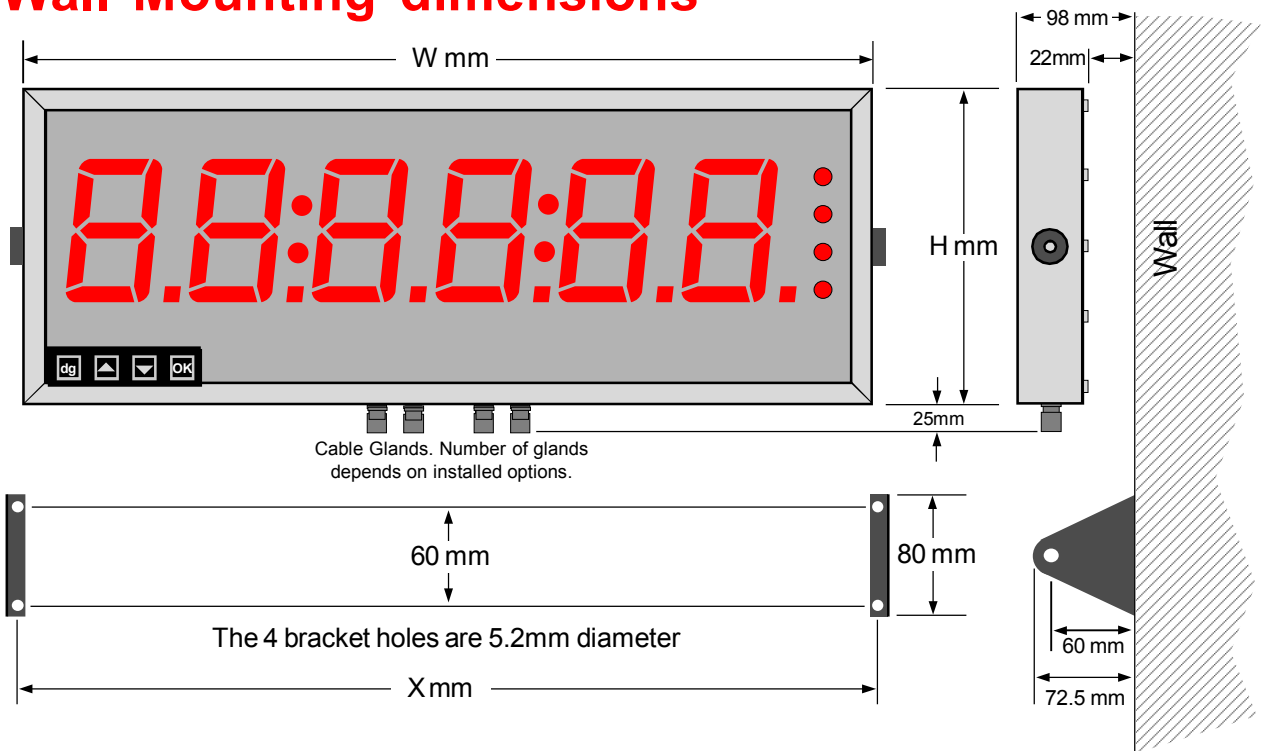

Detail showing bracket hardware fitting sequence

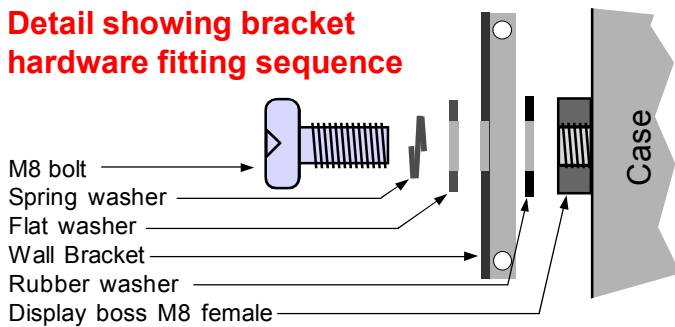

The side holes in the two brackets are 8.5mm dia. to accept M8 bolts.

Display Format	X mm	H mm	W mm
2" 4 digit clock	292	154.5	291
2" 4 digit numeric	280.5	154.5	279.5
2" 6 digit clock	401	154.5	400
2" 6 digit numeric	377	154.5	376
4" 4 digit clock	454	195.5	453
4" 4 digit numeric	435	195.5	434
4" 6 digit clock	654	195.5	653
4" 6 digit numeric	617	195.5	616
6" 4 digit	581	246	580
6" 6 digit	821	246	820
8" 4 digit	751	290	750
8" 6 digit	1073	290	1072
12" 4 digit	1051	408	1050
12" 6 digit	1541	408	1540
16" 4 digit	1369	515	1368
16" 6 digit	2021	515	2020

Panel mounting dimensions

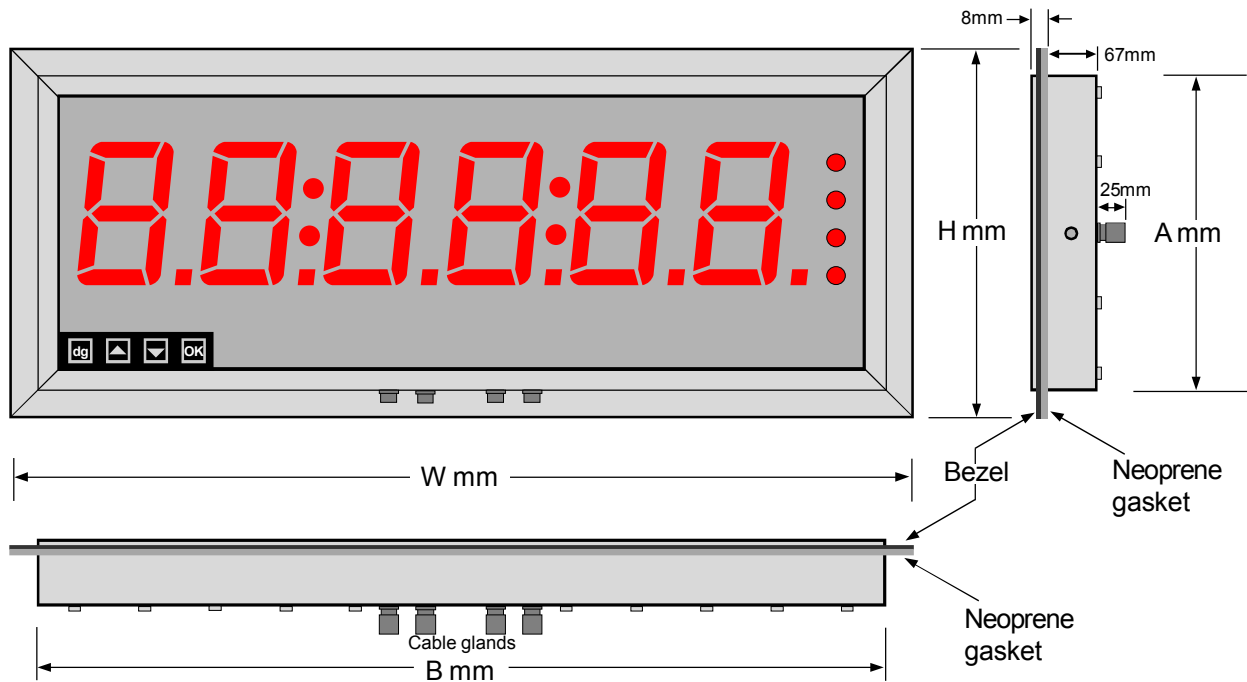

Detail showing bracket hardware fitting sequence

Panel cutout dimensions
 $A+3\text{mm}(h) \times B+3\text{mm}(w)$

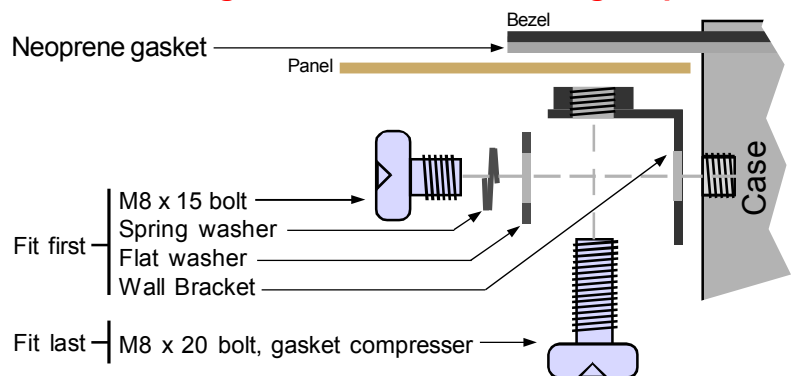

Display Format	H mm	A mm	B mm	Wmm
2" 4 digit clock	172.5	154.5	291	309
2" 4 digit numeric	172.5	154.5	279.5	297.5
2" 6 digit clock	172.5	154.5	400	418
2" 6 digit numeric	172.5	154.5	376	394
4" 4 digit clock	213.5	195.5	453	471
4" 4 digit numeric	213.5	195.5	434	452
4" 6 digit clock	213.5	195.5	653	671
4" 6 digit numeric	213.5	195.5	616	634
6" 4 digit	264	246	580	598
6" 6 digit	264	246	820	838
8" 4 digit	308	290	750	768
8" 6 digit	308	290	1072	1090
12" 4 digit	426	408	1050	1068
12" 6 digit	426	408	1540	1558
16" 4 digit	533	515	1368	1386
16" 6 digit	533	515	2020	2038

Connections



Warning:
Disconnect all power before removing the rear of the display

There is a wide range of possible locations for the input board, output board and power supply board/s. Their locations depend on the height of digits, number of digits, brightness of digits and any installed options. Because the permutation of possible locations is large, we will not describe the location of boards within the display, but simply identify the connectors and their functions on each board, below ...

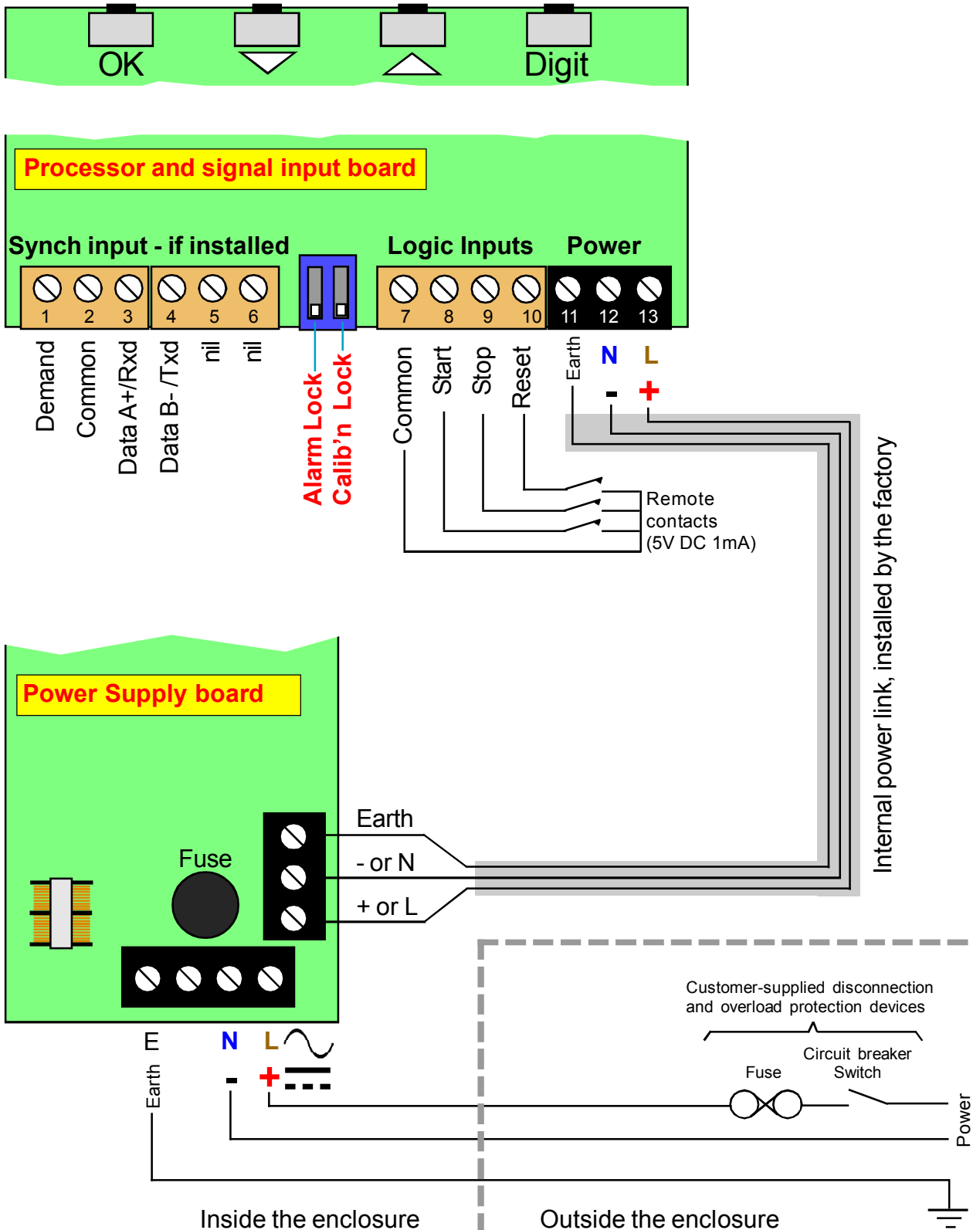

Connections

Warning:
Disconnect all power before removing the rear of the display

Connectors and options
Connectors may be present even if output options are not installed. Refer to rating label to see installed options.

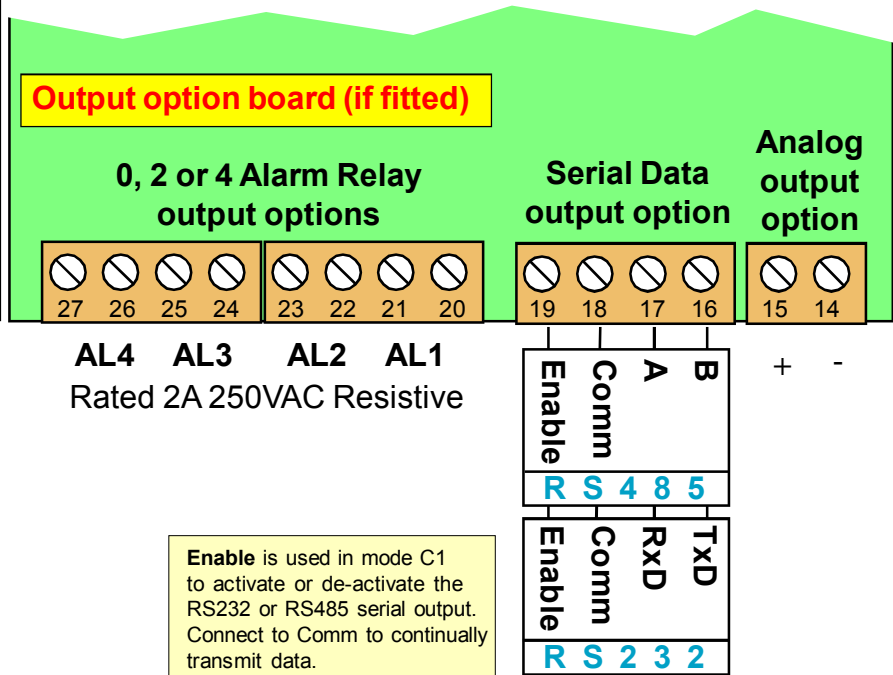

Remote programming button connector

On one of the display boards, you will find a 7 way connector, to which you can wire remote programming buttons, to allow adjustment of the display's settings when the display is inaccessible.

You can also enable or disable the display's front panel buttons, either by a remote contact closure, or by an on-board push-on jumper switch, which is located near to the remote button connector. When the contact is closed, or the push-on switch fitted, the front buttons are enabled.

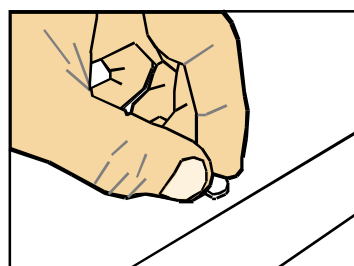
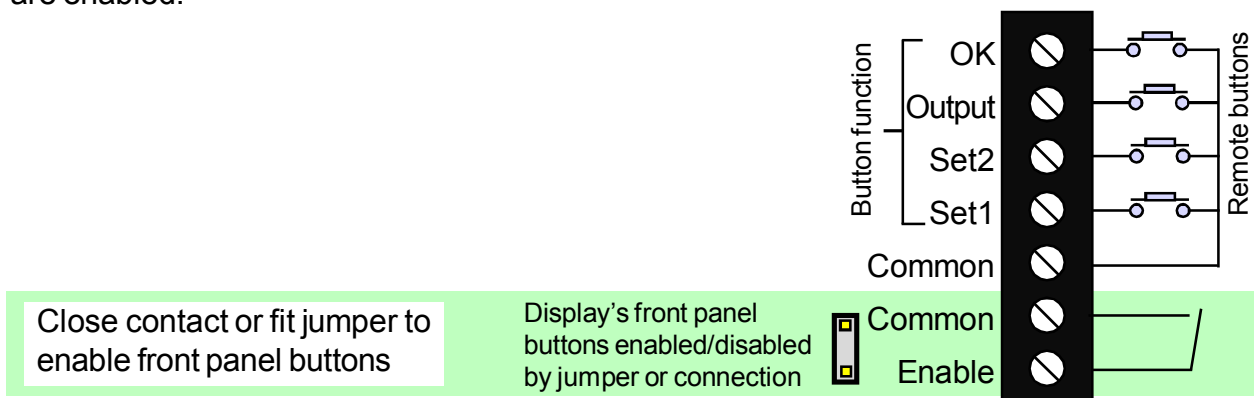

Rear case screws - please note

The rear panel is held in place with finger-screws, which only need to be gently tightened.

Do not use tools to tighten or loosen the screws, as this could cause damage to the internal threads.

Installation hints for best performance

This section offers several suggestions which will help you get the best performance from your measurement system.

The logic input signals are comparatively small and can easily be corrupted by the comparatively high level of electrical noise which can be created by electrical machinery such as motors, welding systems, discharge lighting, AC power inverters and solenoids. These steps will ensure you get the best possible performance from your system.

1. Use good quality screened signal cable, with twisted pairs. Belden 8777NH, Belden 9503 and AlphaWire 6010C are good choices, available from many electrical distributors.
2. If you are using multi-pair twisted cable, each pair should be dedicated to a single display as shown opposite, for maximum noise immunity. This will ensure that any electrical noise induced in the cable is properly cancelled. Mixing destinations carelessly amongst the twisted pairs can actually worsen noise performance.
3. The cable should be routed away from noisy wiring and devices such as power feeds from inverters, discharge-lighting cables, welder cabling etc, and should preferably be routed in a dedicated low voltage signalling/instrumentation conduit or cable tray.
4. Screened cable should be earthed at the display end only.
5. All wires and screens coming out of the screened cable should be kept as short as possible to minimise pickup of noise.
6. If you are using barriers, you should earth your screen as shown below, paying particular care that you do not earth both ends of any run of of cable.

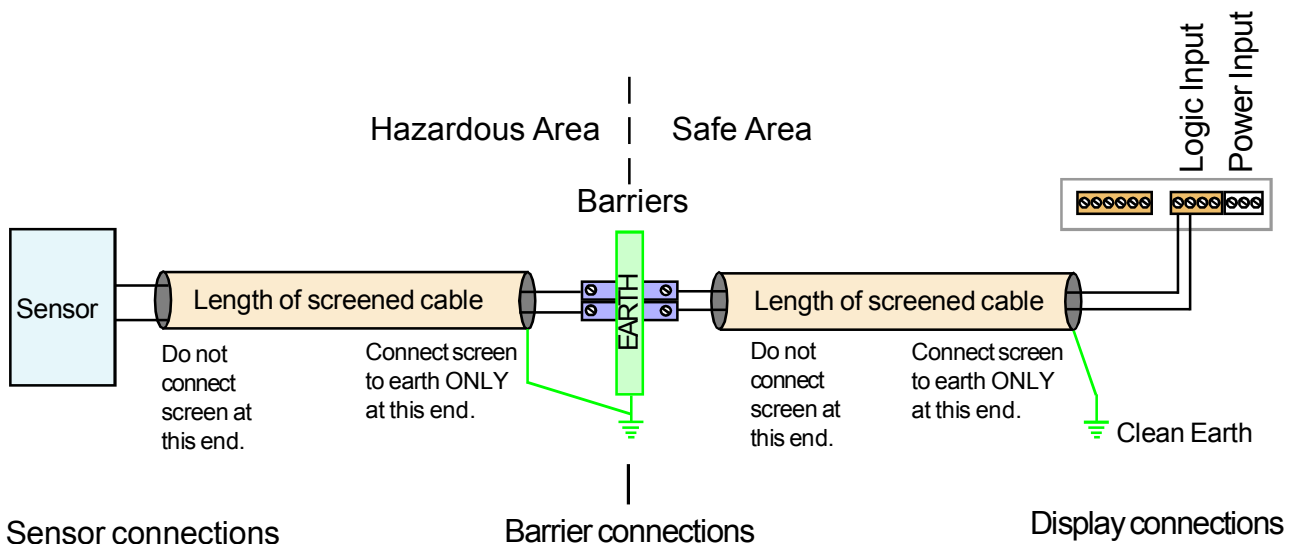

When using multi-core screened cable to connect several displays to several sensors, please be sure to use one twisted pair for each display and sensor.

Do NOT use a wire from one pair for signal positive and a wire from another pair for signal negative, as this will prevent the twisted cables from cancelling any induced electrical noise, and can couple noise from one channel to another.

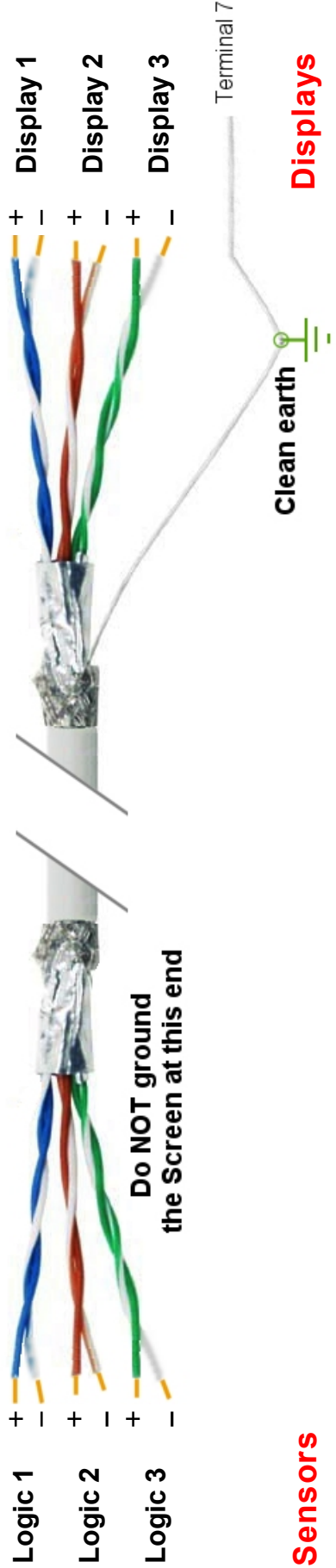

Easy or Advanced menu mode

You can choose from two menu modes.

1. Easy Mode - This limits the menu to the most commonly required features, in order to make it less complex and easier to navigate. This is the default level.

2. Advanced Mode - This gives you access to all available menu features.



Each menu feature in this manual has a heading note to tell you whether it is available in Easy or Advanced mode.

How to choose menu mode:-

This feature is available in Easy and Advanced Modes

- Lockout Switch must be OFF
Circuit board ON

Press together briefly
- Press OK a few times, until you see **Adv.** or **EASY**

Press briefly
- Each press of the DOWN arrow, or UP arrow will alternate between showing **Adv.** or **EASY**

Press to toggle
- Press OK to select your choice.

Press to accept Done!

Display Brightness

You can adjust the display brightness at any time, provided the display is locked.

This feature is available in Easy and Advanced Modes

1

Set1 Digit Set2  Output Alarms OK

Lockout Switch must be ON

OFF ON

Circuit board

Press 3 seconds

2

Set1 Digit Set2  Output Alarms OK

Display shows **br 1**

Each press of the UP button will select a new brightness level. There are 7 brightness levels to choose from. (Default = Full brightness)

Press for 3 seconds

3

Set1 Digit Set2  Output Alarms OK

Max/Min

Reset

Press to accept

Done!



Did you know, we make this display in two brightness versions? Standard brightness for use inside, and Daylight Viewing for use outside in direct sunlight. The Daylight Viewing version has suffix -DLV in its part number.

Mode Setting

The display's calendar and internal clock will need to be set whenever the battery is renewed, and the clock may need to be set from time to time, if it is not synchronised to a master timesource, such as our ASR-GPS

This feature is available in Easy and Advanced Modes

1

Set1
Digit

Set2
▲
Max/Min

Output
▼
Reset

Alarms
OK

Lockout Switch must be OFF



Circuit board ON

Press together for 3 seconds

2

Set1
Digit

Set2
▲
Max/Min

Output
▼
Reset

Alarms
OK

Display shows the available modes



CL.	Clock Mode
dd.MM.yy	Calendar Mode - dd:MM:yy
MM.dd.yy	Calendar Mode - MM:dd:yy
dAY.Cnt	Timer Mode - Days (eg days since last accident)
HH.MM	Timer Mode - HH:MM
MM.SS	Timer Mode - MM:SS
SSSS	Timer Mode - SSSS
SSSSS.t	Timer Mode - SSSSS.t
MMMM	Timer Mode - MMMM
HH.MM.SS	Timer Mode - HH:MM:SS

3

Set1
Digit

Set2
▲
Max/Min

Output
▼
Reset

Alarms
OK



Press to accept



Done!

16

Basic clock configuration

If the display is being used in **Clock Mode**, the following basic configurations will be available

This feature is available in Easy and Advanced Modes

1

Set1
Digit



Set2
Max/Min



Output
Reset

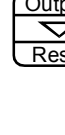

Alarms
OK



Press 3 seconds

Lockout Switch must be OFF

OFF



ON

Circuit board

2

Set1
Digit



Set2
Max/Min



Output
Reset



Alarms
OK



Press to scroll through the available mode choices and press OK to select.

Display shows input channel choices...

Display format...

24h (leading zeros 9am shows 09:00)
12h (no leading zeros 9am shows 9:00)

Daylight saving time modes...

dSt	OFF	US	EU
	None	USA	Europe

Display sequencing dwell times...

C 00.0 Clock visibility time (seconds)
t 00.0 Temperature visibility time (seconds)
H 00.0 Humidity visibility time (seconds)

NB. All three are normally set to 0.00 and are only altered if you connect a remote ASR-GPS master clock to the display, with Temperature and Humidity sensors installed.

3

Set1
Digit



Set2
Max/Min



Output
Reset

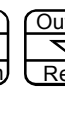

Alarms
OK



Press to accept

Done!

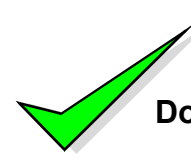

See the following page if you chose Day Counter or Elapsed timer modes...

Timer Mode settings

If the display is being used in Timer Mode, the following basic configurations will be available

This feature is available in Easy and Advanced Modes

1

Set1
Digit

Set2
M in

Output
Reset

Alarms
OK

Lockout Switch must be OFF

Circuit board ON

Press 3 seconds

2

Set1
Digit

Set2
M in

Output
Reset

Alarms
OK

Display shows input channel choices...

Counting direction...

UP Up counting, normally from zero

dn Down counting, normally from preset

Down Count, action on reaching 0

nE9.y Display will go below 0 on down count

nE9.n Display will stop at 0 on down count

The display will flash if negative

Offset adjustments

PrESEt

Display goes to this value whenever it is reset, and the display will normally count down from this value to 0

Pr.LoAd

If a period has already elapsed, when the display is installed (For example you are installing the display to show Days since last Accident and so far there have been 349 days without accident, you would set Pr.Load to 349) you can enter this value here. When the display is reset, the display will go to 0

Press to scroll through the available mode choices and press OK to select.

3

Set1
Digit

Set2
M in
Max/Min

Output
Reset

Alarms
OK

Done!

Press to accept

See the previous page if you chose Clock mode...

RTC setup method

The display's calendar and internal clock will need to be set whenever the battery is renewed, and the clock may need to be set from time to time, if it is not synchronised to a master timesource, such as our ASR-GPS

This feature is available in Easy and Advanced Modes

1

Set1
Digit



Set2
Max/Min

Output
Reset

Alarms
OK

Lockout Switch must be OFF



Press together for 3 seconds

Circuit board ON

2

Set1
Digit

Set2
Max/Min

Output
Reset

Alarms
OK

Display shows each of the parameters and you can move on to the next one with the OK button.
Edit settings with the DIGIT, UP and DOWN buttons, OK to accept. Let us assume it is March 24, 2011. If the time will soon be 14:59 you will set ...

yr. 11	Set the last 2 digits of the year
m 03	Set the month. 1=Jan, 12 = Dec
dt.24	Set the date 1=1st , 31=31st
1459	Set the hour (must be GMT or UTC)*
1459	Set the minutes
1459 	The time will brighten and the 4 leds to the right of the display will flash. At exactly 14:59, press the OK button. No menu timeout.

3

Set1
Digit

Set2
Max/Min

Output
Reset

Alarms
OK



Press to accept



Done!



* For precise GMT / UTC time, please see the blue clock at : <https://www.london-electronics.com/factory-clock-large-display.php>

Factory Defaults

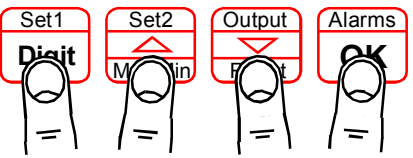

You can return the display to its factory default conditions whenever you wish. If you do so, you will permanently lose all your settings and will need to start from the beginning again.

The calibration Audit Counter will NOT be reset, there is no way provided to reset this value, as it is intended as a secure record to indicate whether changes have been made to the display since it was last calibrated..

This feature is available in Easy and Advanced Modes

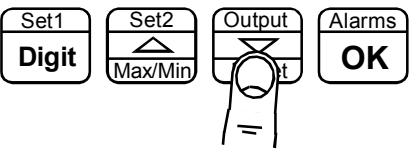
1 —  **Lockout Switch must be OFF** 
Press together for 3 seconds Circuit board ON

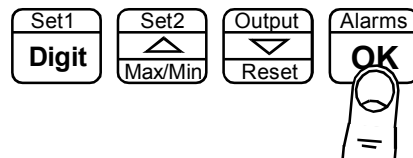

2 —  Display shows :- **dEfn** (Defaults no)
Press the DOWN button to change the display to **dEFY** (Defaults Yes) if you want to return to default conditions.

3 —   **Done!**
Press to accept

Calibration audit number

Your display includes a non-resettable counter which increments each time you make a change to the display's calibration. This is useful if you want to check whether a display has been altered since it was last calibrated.

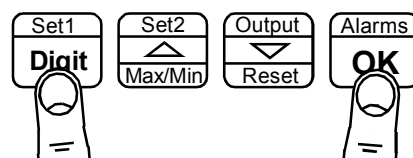
The Calibration audit number starts at **CL01** up to **CLFF** allowing up to 255 alterations to be recorded. Whenever you want to check the calibration audit number, press and hold the 2 outer buttons (Set1 + Alarms) for more than 3 seconds.

1 —   **Done!**
Press together for 3 seconds

Logic input functions

The three contact closure inputs on the rear of the meter have default functions which are:-

Contact closure 1 = Start (starts timing period, clears display to 0 or preset)

Contact closure 2 = Stop

Contact closure 3 = Reset

Note:

You cannot reset or restart the timer if it has not been stopped.

You can tie reset to start to simultaneously reset and start.

You can tie reset to stop to simultaneously reset and stop.

!! This feature is available in Advanced Mode only !!

1

Set1 Digit Set2 Max/Min Output **Start** Alarms **OK** **Lockout Switch must be OFF** OFF

Press 3 seconds

Circuit board ON

2

Set1 Digit Set2 Max/Min Output **Reset** Alarms **OK**

Press repeatedly until you see **CC. 1**, followed by the existing function for Contact Closure 1.

After you have set **CC. 1**, you will get the prompt **CC. 2** to allow you to set Contact Closure 2 function and when you have set CC.2 you will get the prompt **CC. 3** to allow you to set Contact Closure 3 function

3

Set1 Digit Set2 Max/Min Output **Reset** Alarms **OK**

Use UP or DOWN buttons to select from these available functions...

Defaults are:-

CC. 1 = Start

CC. 2 = Stop

CC. 3 = Reset

4

Set1 Digit Set2 Max/Min Output **Reset** Alarms **OK**

Press to accept

Done!

Logic input connections and front buttons

The logic input provides a 5V DC signal. When you connect this to common, a current of 1mA will flow.

Because this is a small signal, we recommend you use switches with gold plated contacts, or self cleaning contacts, for best long term reliability.

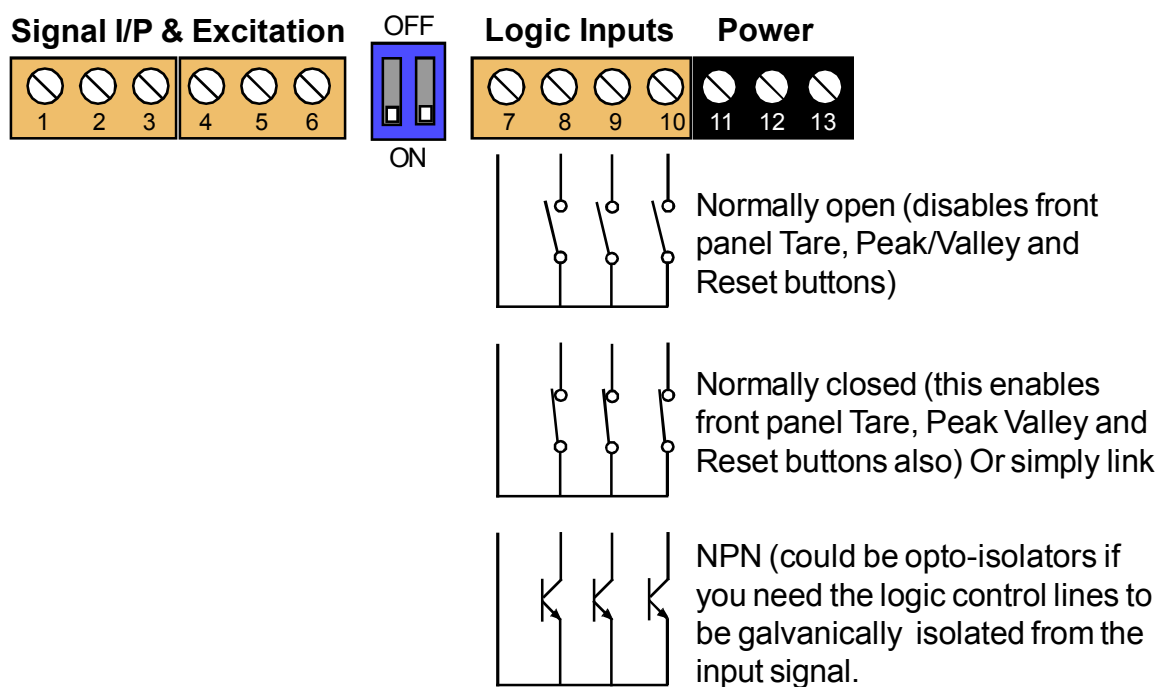

Menu timeout adjustment

The display has a default timeout of 60 seconds, to allow you sufficient time to refer to the manual between key operations.

You can make this period shorter, if you wish, once you become more familiar with the setup method.

!! This feature is available in Advanced Mode only !!

1

Set1 Digit Set2 Max/Min Output Alarms

Lockout Switch must be OFF

Circuit board ON

Press together, briefly

2

Set1 Digit Set2 Max/Min Output Reset Alarms OK

Press repeatedly until you see **dLAY. XX** where **XX** is the delay in seconds. Choices are ...

dLAY. 10
dLAY. 20
dLAY. 30
dLAY. 60 (default)

3

Set1 Digit Set2 Max/Min Output Reset Alarms OK

Press DOWN or UP button briefly and repeatedly to choose from **dLAY. 10** or **dLAY. 20** or **dLAY. 30** or **dLAY. 60**

Press briefly to toggle

4

Set1 Digit Set2 Max/Min Output Reset Alarms OK

Press to accept

Done!

Reverse Display function (mirror image)

If you need to be able to see a reflection of the display in a mirror or other reflective surface, for example in a simple heads-up system, or for drivers reversing into a bay, using mirrors only, you can set the display to show as a mirror image.

!! This feature is available in Advanced Mode only !!

- Lockout Switch must be OFF

Circuit board ON

Press together, briefly
- Press OK button briefly and repeatedly until you see

rEU.d 0 (Default)
or
rEU.d 1
- Press DOWN or UP button briefly and repeatedly to choose from

rEU.d 0 (normal display) or
rEU.d 1 (mirror image display)

Press briefly to toggle
- Press to accept

Done!



Example of normal display format displaying the number 876543



Example of Mirror Reverse display format displaying the number 876543

Bootup routine choices

When you switch on your meter, it can be set to power up with 3 possible summary message combinations.

The choices are:-

- boot 0** = Segment test, followed by a full summary of software revision, calibration audit number, model number, installed options.
- boot 1** = Segment test followed by model number (Default)
- boot 2** = No summary, meter displays the measurement value immediately power is applied.
- boot 3** = Segment test which remains active until a button is pressed.

!! This feature is available in Advanced Mode only !!

1

Set1
Digit

Set2
Max/Min

Output
↓

Alarms
↓

Lockout Switch must be OFF

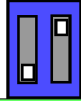
OFF

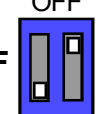

Press together, briefly

Circuit board ON

2

Set1
Digit

Set2
Max/Min

Output
↓
Reset

Alarms
OK

Press OK button briefly and repeatedly until you see **boot 0** or **boot 1** or **boot 2** or **boot 3** displayed.



3

Set1
Digit

Set2
Max/Min

Output
↓
↑

Alarms
OK

Press DOWN or UP button briefly and repeatedly to choose from **boot 0** or **boot 1** or **boot 2** or **boot 3**

Press briefly to toggle

4

Set1
Digit

Set2
Max/Min

Output
↓
Reset

Alarms
OK

 **Done!**

Press to accept



You can trigger the full summary message whenever you want, without having to power the meter off, by pressing and holding the 2 outer buttons (Set1 + Alarms) for more than 3 seconds.

Language Selection for user interface

You can select English or French menu prompts.

This feature is available in Easy and Advanced Modes

1

Set1 Digit Set2 Max/Min Output Alarms Lockout Switch must be OFF OFF

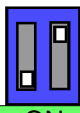

Press together, briefly

Circuit board ON

2

Set1 Digit Set2 Max/Min Output Alarms OK

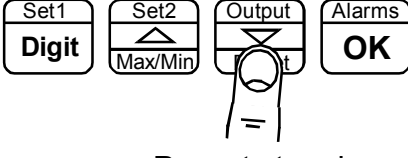

Press to toggle

Display shows
L.En9 (Default)
for User Interface English
or
L.FrA
for User Interface French

3

Set1 Digit Set2 Max/Min Output Reset Alarms OK

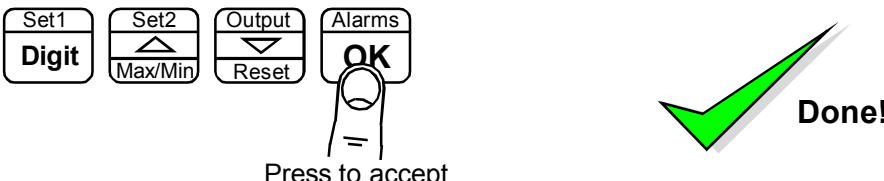

Press to accept

Done!

Error codes and fault finding

1. Time does not automatically correct at summer/winter time changeover.

Check that the **dst** has been set to your region.

How to install option boards



Where the product is intended for “UL” installations removal or addition of option boards is not permitted.



Warning: Disconnect power before you expose the internals of the display

If you want to open your display to install or modify option boards, follow these steps...

- 1) Switch off power to the display and unplug all connectors.
- 2) Undo all the thumb screws on the rear case, store them safely and remove the back panel
- 3) Locate the main option board, which will be similar in appearance to the diagram below. If a main option board is absent, which will be the case if the display was ordered without any output options, then a main option board will need to be fitted.

The board assemblies will look like this...

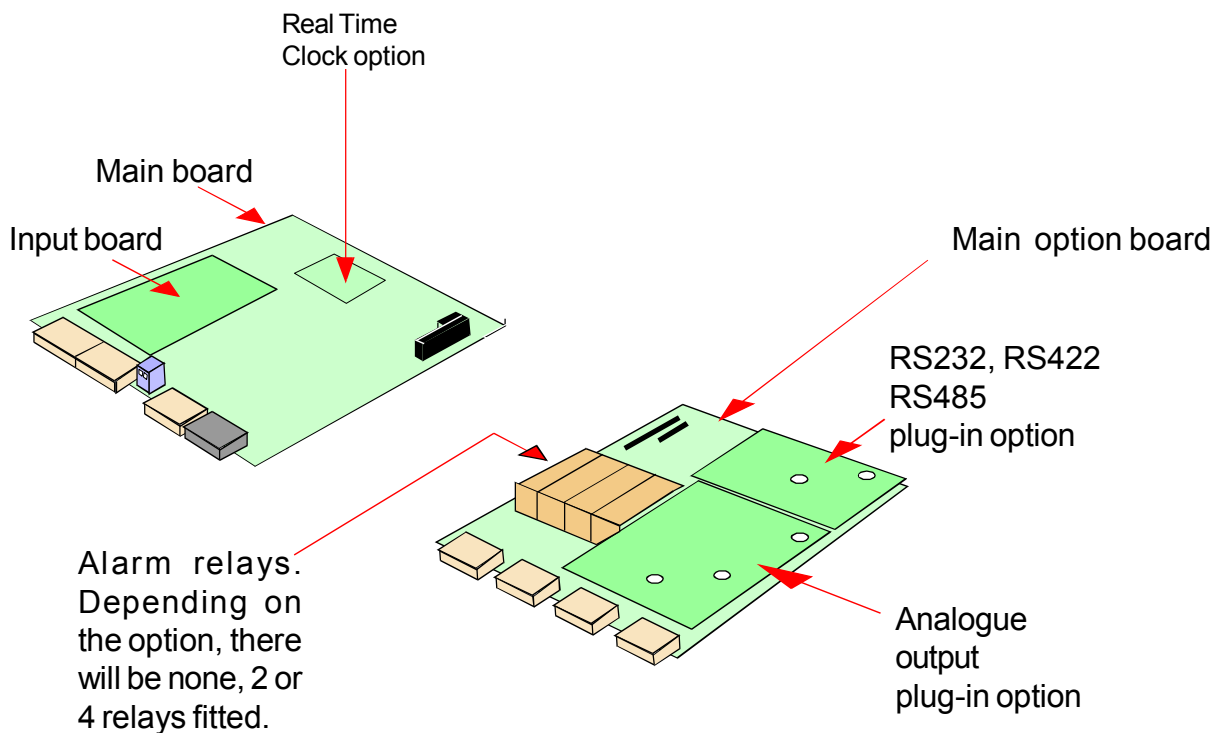

The analogue output and RS232 or RS422 plug-in option boards are fixed to the main option board with white plastic pillars. You must apply a firm force when fitting or removing these options.

Always be careful to connect the pins to sockets accurately. When reassembling, make sure option boards are firmly fixed to the upper option board.

Waste Electrical Electronic Equipment (WEEE)

In Europe, this equipment must be disposed of in accordance with European Parliamentary Directive 2002/96/EC

This directive encourages recycling and the reduction of waste materials in the environment.

This means it must be sent to an approved recycling plant if you want to dispose of it.

It must not be thrown away with general rubbish.



WEEE Waste Recycling

If you are unable to dispose of this item locally, you may send it to us for recycling.

Conditions:

1. We will only accept items of our manufacture.
2. You must pay for the transport of the goods to us.
3. We will only accept items if they include a signed declaration by an authorised person in your organisation, stating that :-
 - i. The item is safe to handle and has no contaminants which may be harmful to health.
 - ii. You wish us to dispose of or destroy the item(s)

Equipment Specifications

Case Material	Heavy duty welded uPVC
Connectors	Internal detachable Screw Terminal connectors accessed via compression glands
Environmental	Storage Temperature range -20 to +70C, non condensing Operating temperature range 0 to 50C. Internal heater option available for use in conditions down to -25C. Allow 30 minutes to allow the display to reach thermal equilibrium
Power Burden	100-240 VAC, 48 VAC 45 to 60Hz or 11-30 VDC optional 40VA maximum
Sealing	IP65 all round, provided the display is mounted vertically and that all cable glands and rear case-closure screws are properly secured.
Accuracy	Better than +/- 10 seconds per month (DS3231SN) Battery backup during power loss. Battery = CR1620 3V Lithium Allow 30 minutes after switch-on, for thermal stabilisation.
Memory	Totals and settings saved in 10 year non-volatile memory.

Plug-In Output Options

Analogue O/P

Alarm Relay O/P

ASCII Data O/P

Calendar/Clock option

Please see supplementary manuals available on our website, or supplied with the product.

Record of Revisions

6 September 2010	Version F00.18 Software released. Manual format revised to improve clarity and segregate easy from advanced menu functions. Optional outputs now described in their own dedicated manuals. DIN Rail mounting option added. Cabling guidance added.
13 December 2010	Version F00.20 software released (version F00.19 not issued on this model) No performance or feature changes to report in this version.
9 February 2011	Version F00.21 software released.
28 February 2011	Warranty increased to 3 years and terms added.
22 August 2011	Corrected Remote programmer connector details.
31 July 2012	Version F00.22 software released. New timer modes and display formats.
17 July 2019	Revised software version. Start logic input clears display to 0 on start
6 august 2021	Clarified Start / Stope / Reset sequence

Declaration of CE Conformity

Declaration Reference : Fusion
Issue Date : 30 April 2007
Products Covered : Fusion series
Title : DOC-Fusion

This is to confirm that the Product covered by this declaration has been designed and manufactured to meet the limits of the following EMC Standard :

EN61326-1:1997

and has been designed to meet the applicable sections of the following safety standards

EN61010-1:2001



Conditions

The meters are permitted a worst case error of 1% of A/D range during electro-magnetic disturbance, and must recover automatically when disturbance ceases without the need for human intervention, such as resetting, power-down etc.

The meters covered by this certificate must be installed in adherence to the following conditions :-

Signal cabling shall be routed separately to power carrying cabling (includes relay output wiring)

All signal cabling shall be screened. The screen shall only be terminated to the power earth terminal at the meter end of the cable.