

## London Electronics Limited

Thorncote Road, Near Sandy, Bedfordshire SG19 1PU  
Tel +44(0)1767 626444 Fax +44(0)1767 626446  
www.london-electronics.com help@london-electronics.com

## Panel mounting ASCII slave display **MAXI-INT4-S**

### Installation & Operating Manual



- ✓ Easy setup
- ✓ Accepts RS232, RS485, RS422
- ✓ Display = 3, 4, 5 or 6 digits (configurable)
- ✓ Optional Output 4-20mA / 0-10V isolated
- ✓ Optional Alarm output = 2 or 4 relays
- ✓ Optional Comms Output = RS232 or RS485
- ✓ 110-230V AC or 11-30V DC power

**Caution:** There is a risk of electrical shock if this instrument is not properly installed



**Caution:** Risk of danger: Read the whole manual before you install this meter



# Warranty

We warrant this product against defects in materials or workmanship for a period of three (3) years from the date of purchase.

In the event of a defect during the warranty period, the unit should be returned, freight (and all duties and taxes) prepaid by the Buyer to the authorised distributor from where the unit was purchased.

The Distributor, at its option, will repair or replace the defective unit. The unit will be returned to the Buyer with freight charges prepaid by the distributor.

## LIMITATION OF WARRANTY

The foregoing warranty shall not apply to defects resulting from:

1. Improper or inadequate maintenance by the buyer.
2. Unauthorised modification or misuse.
3. Operation outside the environmental specification of the product.
4. Mishandling or abuse.

The warranty set forth above is exclusive and no other warranty, whether written or oral is expressed or implied. We specifically disclaim the implied warranties of merchantability and fitness for a particular purpose.

## EXCLUSIVE REMEDIES

The remedies provided herein are the buyer's sole and exclusive remedies.

In no event shall we be liable for direct, indirect, incidental or consequential damages (including loss of profits) whether based on contract, tort or any other legal theory.

Ordering code: **INT4-X-X-X-X-X-X-X**

**INT4** = Intuitive Mark 4 family  
**S2** = RS232 input, **S4** = RS485 input  
Analogue output: — **0**=none, — **ANB**=-10to+10V, — **ANI**=4-20mA, — **ANV**=0-10V  
Alarm outputs: — **0**=none, — **AL2**= 2 relays, — **AL4**=4 relays  
Serial data: — **0**= none, — **232**=RS232, — **485**=RS485  
Display colour: — **R**=Red, — **G**=Green  
Power: — **AC**=100-240V AC, — **DC**=11-30V DC  
Mounting: — **0** = Standard panel **DIN** = DIN rail mounting

# Contents

Warnings	4
Introduction	5
General Description	6
Panel mounting & Installation - Class II	7
Wiring Advice	8
Connections	9
Installation hints for best performance	10-11
Application Notes	12
Language Selection	13
Display Brightness	14
Display Modes	15
Serial Data settings	16-17
Logic Input functions	18
Logic Input connections & Front Buttons	19
Factory defaults	20
Calibration Audit number	20
Scale Factor adjustment	21
Offset Adjustment	22
Menu Timeout adjustment	23
Reverse / Mirror display setting	24
Bootup Routine choices	25
Multi Memory MEM option	26
Error Codes and fault finding	27
Output Options - installing	28
WEEE	29
Equipment Specifications	30
Record of Revisions	31
ASCII Hex codes and displayed characters	32
Signal Levels	33
Special data commands	34
Declaration of Conformity	35

## **Separate manuals for options**

Alarm option settings	See Alarm manual *
Analogue output option settings	See Analogue manual *
Serial output option settings	See Serial manual *
Real Time Clock setting	See Serial manual *

\* Need a manual urgently?

You can download manuals from our website.

# Warnings

Please carefully read this manual and all warnings. Install the meter ONLY when you are sure that you've covered all aspects.



Where the product is intended for "UL" installations, removal or addition of option boards is not permitted.



Check that the model number and supply voltage suit your application before you install the meter.



Connect the meter according to current IEE regulations, IEC61010 & NFPA:70 National Electric Code in USA.



This meter is for Installation class II service only. This means it has exposed electrical and power terminals. You must install it in a suitable fire enclosure which will also protect users from electric shock



We designed this meter for Pollution-Degree 2 environments only.



Power supplies to this equipment must have anti-surge (T) fuses rated at 400mA for 230V supply, 400mA for 110V supply or 2A for DC supplies in the range 11-30VDC. Only Siba fuses in series 189500, cULus listed according to file #E167295 are accepted for this service under the terms of UL listing. A switch or circuit breaker, clearly marked as a disconnecting device, must be included close to the installation.



Don't touch any circuitry after you have connected the meter, because there may be lethal voltages on the circuit board.



Only adjust on-board switches or connections with the power turned off



Make sure all screw terminals are tight before you switch the meter on.



Only clean the meter's front with a soft damp cloth. Only lightly dampen with water. Do not use any other solvents. The behind-panel case may be cleaned with a dry cloth only, use no liquid or solvent on it.

**Safety First .....Don't assume anything..... Always double check.  
If in doubt, ask someone who is QUALIFIED to assist you in the subject.**

# Introduction

Please contact us if you need help, if you have a complaint, or if you have suggestions to help us improve our products or services.

If you contact us about a product you already have, please tell us the full model number and serial number, so that we can give you accurate and fast help.

This product has a 3 year warranty. We will put right or replace any meter which is faulty because of bad workmanship or materials. This warranty does not cover damage caused by misuse or accident.

If you return a unit for repair, please include a detailed description of the problem, and the name of a contact who we can refer to for any questions. Please mark for the attention of the QA Department.

## **IMPORTANT**

If this equipment is important to your process, you may want to buy a spare to cover possible failure or accidental damage in the future.

This is because during factory shutdown periods, you may have to wait several weeks for an equivalent replacement, or we may have no stock at the time you urgently need it.

You may also need to pay extra carriage charges if you want a fast, guaranteed courier service. Warranty repairs or replacements are usually returned with a standard courier service.

We do not offer compensation for losses caused by failure of this instrument.

We thought you'd prefer to know about possible delays and extra charges now, rather than during a panic. A spare unit could help to avoid these issues.

We always try to improve our products and services, so these may change over time. You should keep this manual safely, because future manuals, for new designs, may not describe this product accurately.

We believe these instructions are accurate, and that we have competently designed and manufactured the product, but please let us know if you find any errors.

# General Description

This series of meters accepts industrial sensors to allow various physical measurements to be made, such as weight, temperature, pressure, humidity etc. Different models are available for different sensor types.

The main function of this series is to give a numeric readout of the variable being monitored. Most models include an excitation power output, to power the sensor directly.

Various optional output modules are also available to give alarm relay outputs, analogue output or digital communications, or any combination of these options.

Meters are programmed using front panel pushbuttons. The buttons may be locked with a rear switch.

Meters have two power supply options : 100-240 VAC or 11-30VDC

These meters are designed to mount into a protective enclosure which will protect users from contact with power and signal wiring.

These units must be installed fully assembled, and must be installed according to local electrical installation rules. When properly installed, they provide ingress protection to IP65 / NEMA4X from the front

## Safety



**Caution:** There is a risk of electrical shock if this instrument is not properly installed



**Caution:** Risk of danger: Read the whole manual before you install this meter

Obey all safety warnings in this manual, and install the meter according to local wiring and installation regulations. Failure to follow these guidelines may cause damage to the meter, connected equipment, or may be harmful to personnel.

Any moving mechanical device controlled by this equipment must have suitable access guards to prevent injury to personnel if the meter should fail.

# Panel Mounting and Installation - Class II

Install these meters in a suitable protective electrical control enclosure according to local wiring regulations. See specifications for maximum allowable temperature in enclosure. Allow adequate air circulation.

**Installing into front of panel**  
Remove the two screw clamp assemblies and safely store them for later fitting.

138mm +1mm -0mm  
67.5mm +1mm -0mm  
Panel cutout

Slide the meter, with gasket into the panel cutout

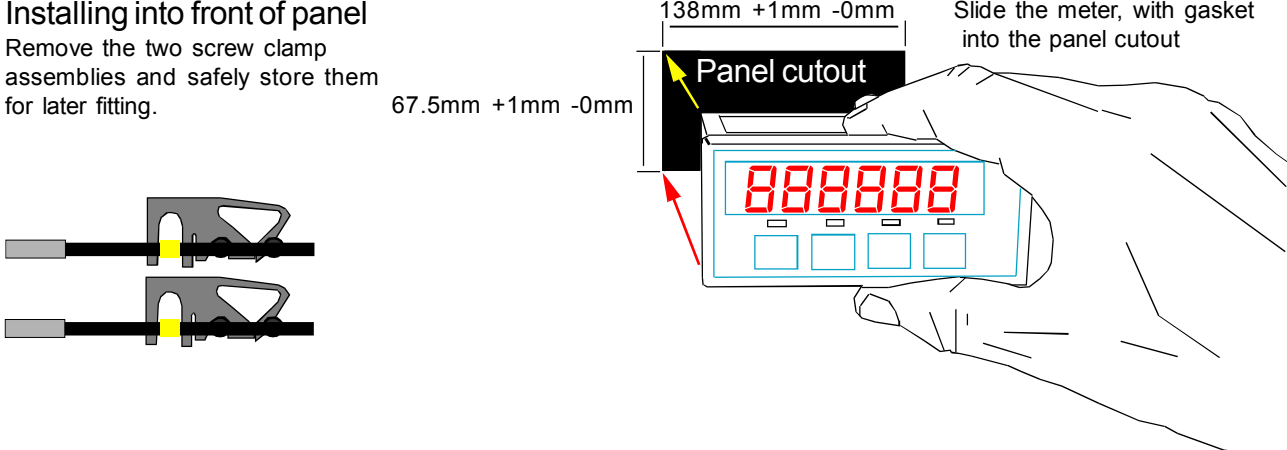

## Securing into the panel

Re-fit the screw clamp assemblies and tighten the screws to firmly clamp the meter in place.

## Ventilation

There should be sufficient ventilation in the enclosure to ensure that the meter's case is always kept to less than 60C.

## Meter Spacing.

Meters should be spaced apart sufficiently to allow a free flow of ventilation air around the meters, such that no part of the case will exceed 60C

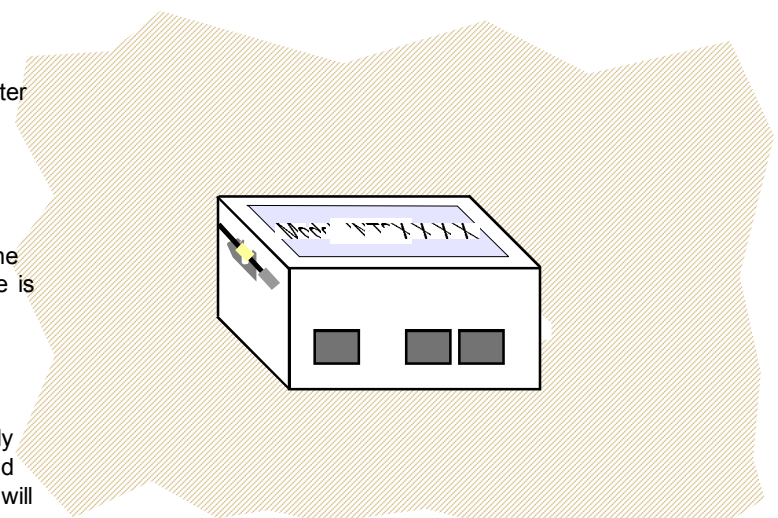

## Side view of meter installed in panel

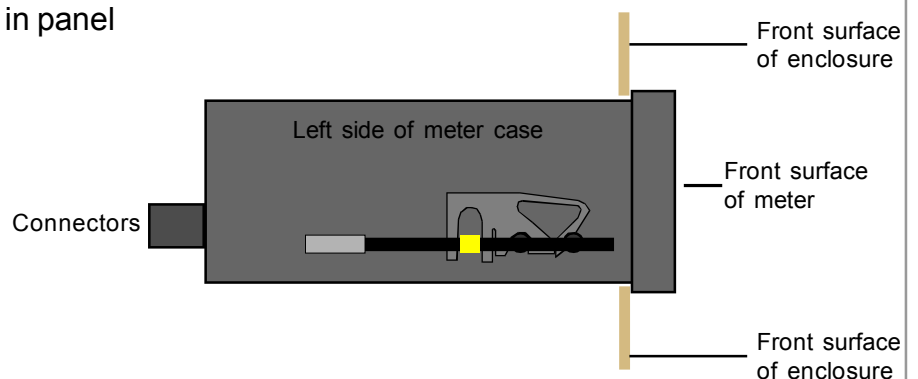

# Wiring Advice

This meter uses detachable screw terminal connectors. Refer to the wiring diagram on the following page for the correct positioning of each wire.

The conductors you use must be suitable for the meter's temperature, current and voltage rating, which is broadly described as follows:-

## Cable Temperature Rating

All cables must be rated for operation up to 90C continuous.

## Cable gauge and screw tightness

The connectors on this instrument can accept conductors up to 16 gauge AWG / 1.5mm<sup>2</sup> c.s.a. The minimum cross sectional area shall be 22 gauge AWG / 0.5mm<sup>2</sup>. Tighten screw terminals to 7.0 lb/in torque / 0.8 Nm torque.

## Cable insulation voltage rating

Cables shall have an insulation voltage rating of at least 380V continuous.

Wire preparation:

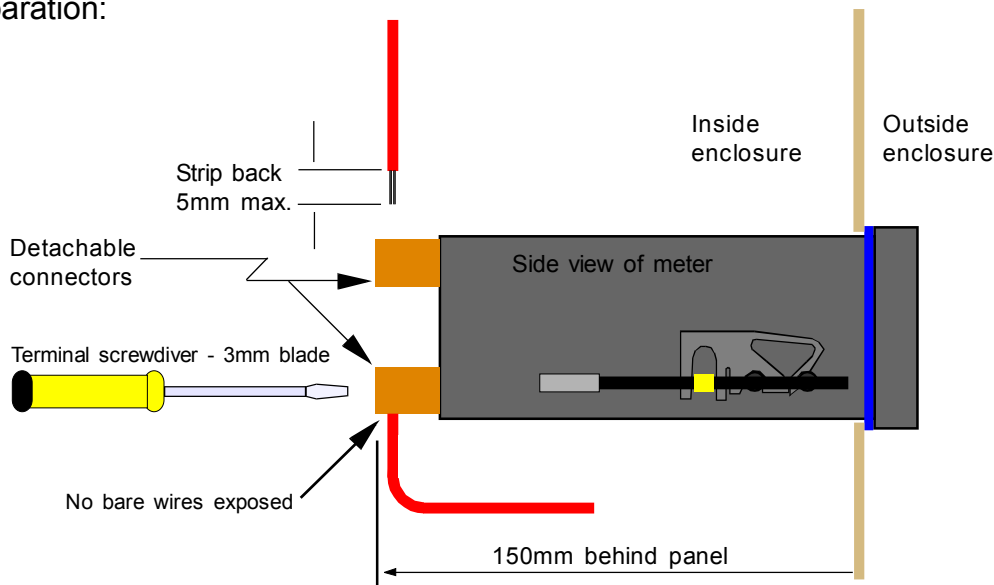

We recommend multi-strand wire, because it withstands vibration better than single strand cable. Pull the wire firmly after you make the connection to confirm it is tight.

Use screened cable for all signal and control wiring and connect the screen to earth at the destination end only. Route signal cabling away from power cabling and relay switching cabling, to avoid electrical noise interference.



# Connections

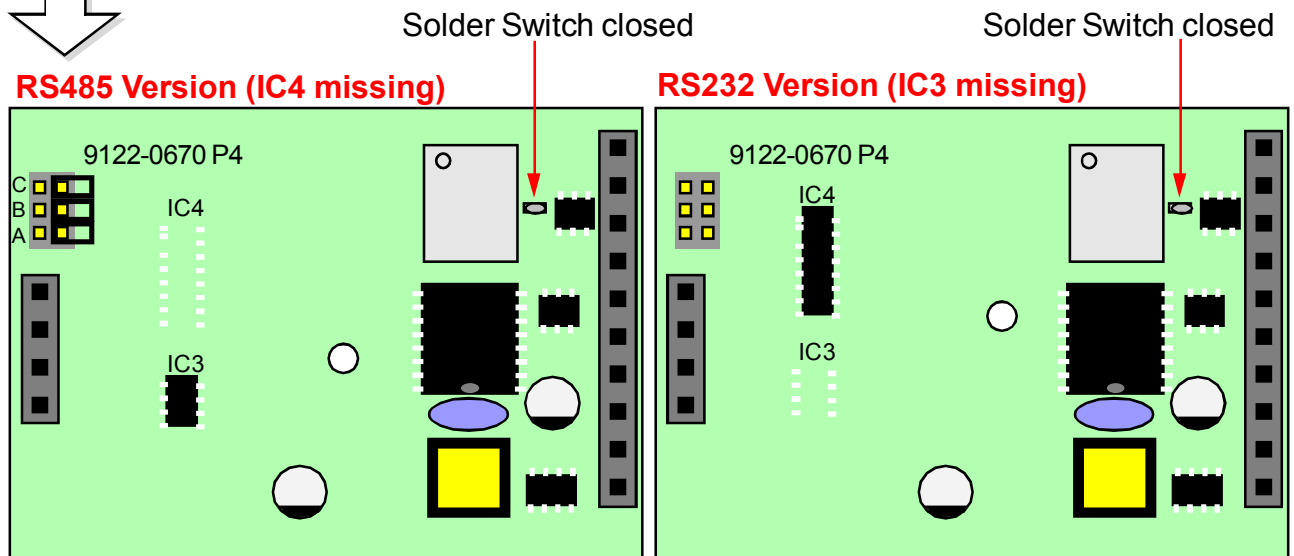
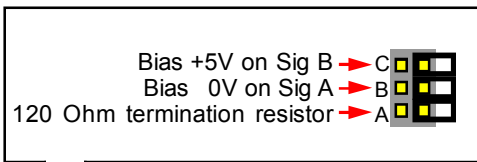
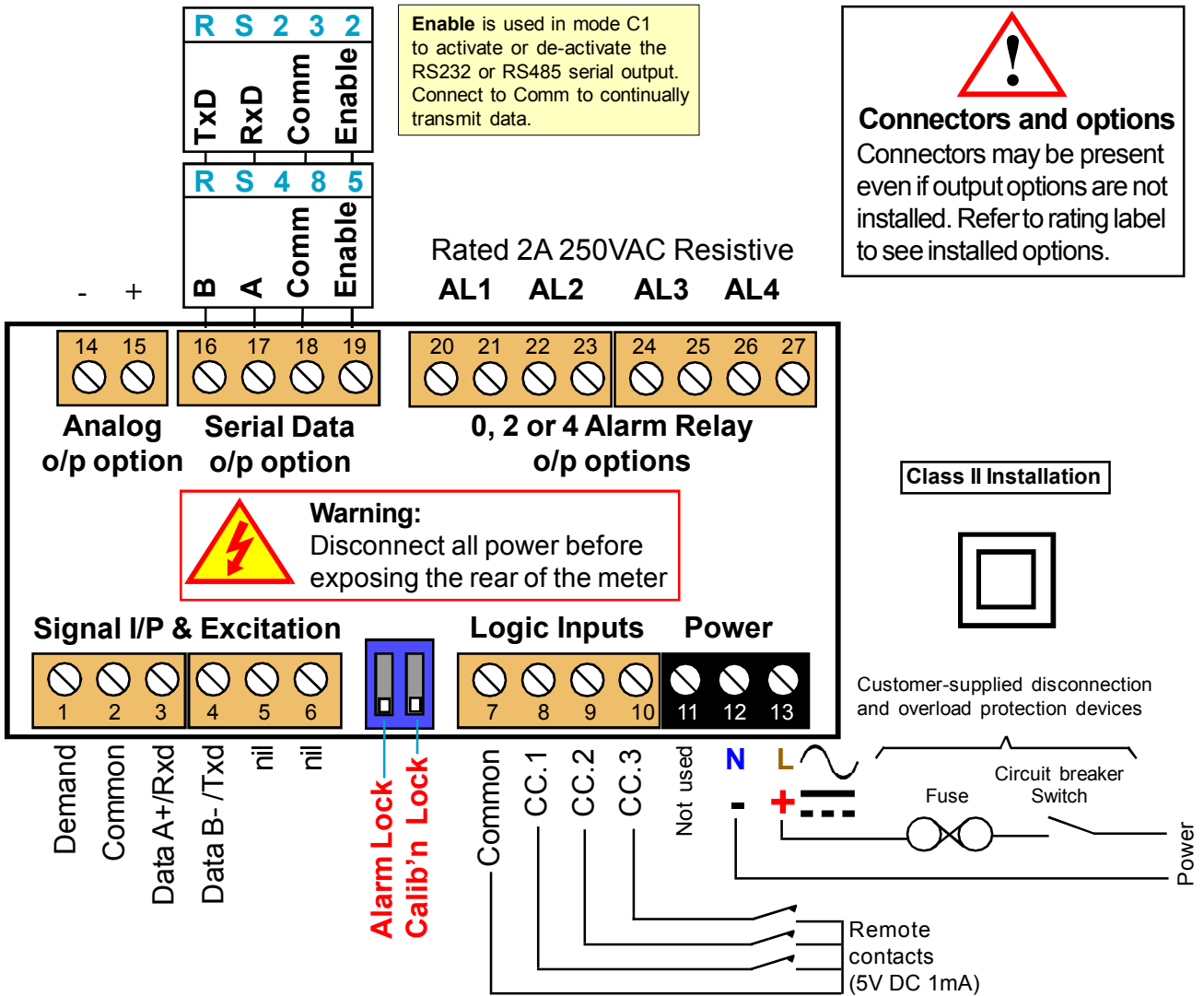

# Installation hints for best performance

This section offers several suggestions which will help you get the best performance from your system.

RS232 and RS485 use comparatively small signals which can easily be corrupted by the potentially high level of electrical noise which can be created by electrical machinery such as motors, welding systems, discharge lighting, AC power inverters and solenoids. These steps will ensure you get the best possible performance from your system.

RS232 has limited capability over long cable distances, due its low driving power (which causes the signal to reduce in level as cable length increases) and single ended signal (which is prone to interference by local electrical noise) , as shown below...

Maximum recommended cable distances if using LOW capacitance screened cable such as CAT5 cable.		
Baud Rate	RS232	RS485 or RS422
1200	50m	1200m
9600	20m	150m
19200	10m	75m
38400	5m	30m
115200	2m	10m

1. Use good quality screened signal cable, with twisted pairs. Screened twisted pair CAT5 cable is ideal. The screen should be earthed at the display end only.
2. If you are using multi-pair twisted cable, each pair should be dedicated to a single display as shown opposite, for maximum noise immunity. This will ensure that any electrical noise induced in the cable is properly cancelled. Mixing destinations carelessly amongst the twisted pairs can easily corrupt data.
3. The cable should be routed away from noisy wiring and devices such as power feeds from inverters, discharge-lighting cables, welder cabling etc, and should preferably be routed in a dedicated low voltage signalling/instrumentation conduit or cable tray.
4. If you want to simulate data, a useful free terminal, with good flexibility is RealTerm, available from <http://sourceforge.net/projects/realterm/>

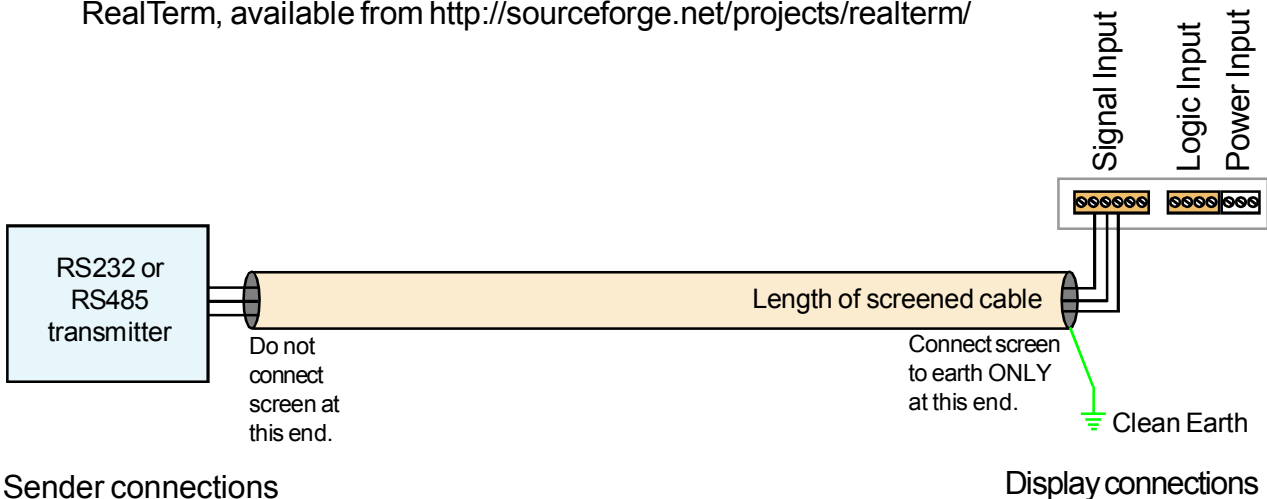

When using multi-core screened cable to connect several displays to several data sources, please be sure to use one twisted pair for each display and sensor.

Do NOT use a wire from one pair for signal positive and a wire from another pair for signal negative, as this will prevent the twisted cables from cancelling any induced electrical noise, and can couple noise from one source to another.

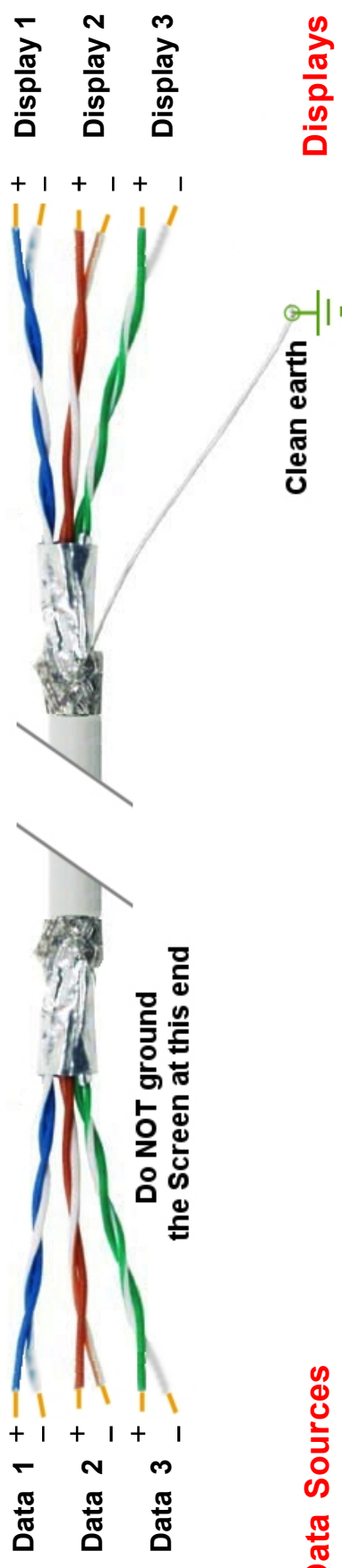

# Application Notes

# Language Selection for user interface

You can select English or French menu prompts.

**1**

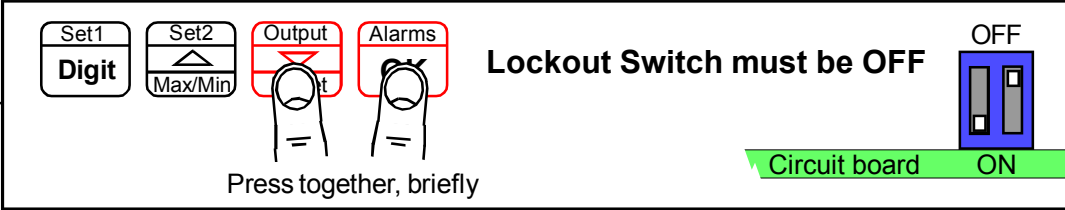

Set1 Digit   Set2 Max/Min   Output   Alarms

Lockout Switch must be OFF

OFF

Circuit board ON

Press together, briefly

**2**

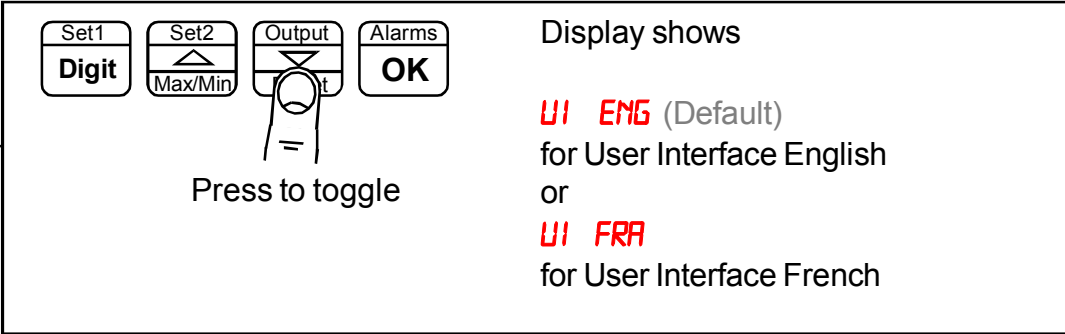

Set1 Digit   Set2 Max/Min   Output   Alarms OK

Display shows

**UI ENG** (Default)  
for User Interface English  
or  
**UI FRA**  
for User Interface French

Press to toggle

**3**

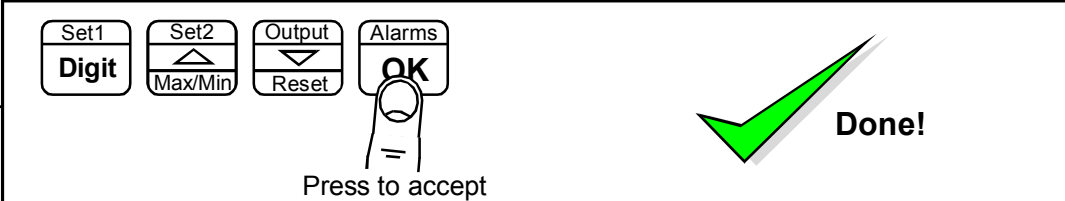

Set1 Digit   Set2 Max/Min   Output Reset   Alarms OK

Done!

Press to accept

# Display Brightness

You can adjust the display brightness at any time, provided the display is locked.

**1**

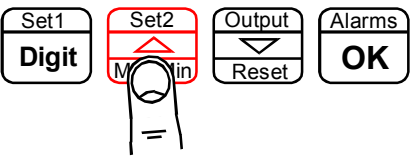

Press 3 seconds

Lockout Switch must be ON

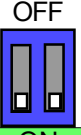

Circuit board ON

**2**

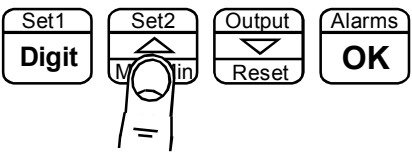

Press for 3 seconds

Display shows **BRIGHT**  
Each press of the UP button will select a new brightness level. There are 7 brightness levels to choose from.  
(Default = Full brightness)

**3**

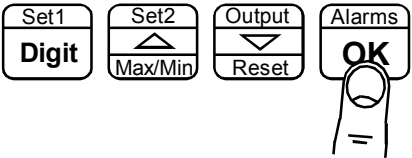

Press to accept



Done!



Did you know, we make this display in two brightness versions? Standard brightness for use inside, and Daylight Viewing for use outside in direct sunlight. The Daylight Viewing version has suffix -DLV in its part number.

# Display Modes

You can choose from three operating modes.

**1**

Set1 Digit Set2 Max/Min Output Reset Alarms OK Lockout Switch must be OFF

Press 3 seconds

Circuit board ON

**2**

Set1 Digit Set2 Max/Min Output Reset Alarms OK Display shows *ASCII*, *QUANT* or *QUA.TOT*

Press to select

*ASCII* is used for any application where non-numeric characters may need to be displayed. You can not have alarms, analogue output, tare, peak, valley or any mathematical functions with this mode.

*QUANT* is used for any numeric display work which needs alarms, analogue output, tare, peak, valley or mathematical functions.

*QUA.TOT* is used in applications where you want to sum values, for example to add together ingredient weights to get a combined weight.

**3**

Set1 Digit Set2 Max/Min Output Reset Alarms OK

Press to accept

Done!

# Serial Data settings

Choose the serial data settings to suit the transmitting device.

1

**Lockout Switch must be OFF**

Press 3 seconds

2

Display shows each of the parameters and you can edit or move on to the next one with the OK button.

You can edit the settings with the DIGIT, UP and DOWN buttons. OK to accept.

The default parameters are:-

<b>ADDR. 01</b>	The display's address, from 00 to FF. Choose 00 if you do not need addressing.
<b>S.CHR. 02</b>	The Start Character. 02 = STX. Select 00 if you do not have a defined start character.
<b>E.CHR. 03</b>	The End Character. 03 is ETX, 0d is Carriage return
<b>BAUD 9600</b>	Choose a baud rate to suit the sender.
<b>DF. 8N1</b>	Data format 8 data bits, no parity, 1 stop
<b>T.REP. 05</b>	Time to reply following a request, in mS
<b>T.CHR. 00</b>	Time in mS between each character.
<b>TO. 03</b>	Timeout Secs. if data lost. Display shows -----
<b>S.POS. 00</b>	Start position for data editing (see opposite)
<b>D.LEN. 06</b>	Data length for editing (see opposite)
<b>D.D.D.D.D.D.</b>	Decimal point position for alarms
<b>DP.A or DP.F</b>	Decimal point Automatic (in string) or Fixed

3

**Done!**

Press to accept



# Serial Data setting examples

## Sending data to an addressed display

Let us assume the display has address 45 and you want to send the value 123.4 to it at 19200 baud. Your data will be sent as <STX>45123.4<CR>

Set

```
ADDR.45, S.CHR.02, E.CHR.00, BAUD 19200, DF.8Y1,
T.REP.05, T.CHR.00, TO.03, S.POS.00, D.LEN.06,
DDDD.D, DP.A
```

## Extracting data from a complex string (data editing)

Let us assume the data is sent as a complex string at 1200 baud such as ...

<Start Char><Address Characters><Data: ligo6ho987hmw1234.56kg abcd><End Char.>  
and you want to display only the numeric weight value...

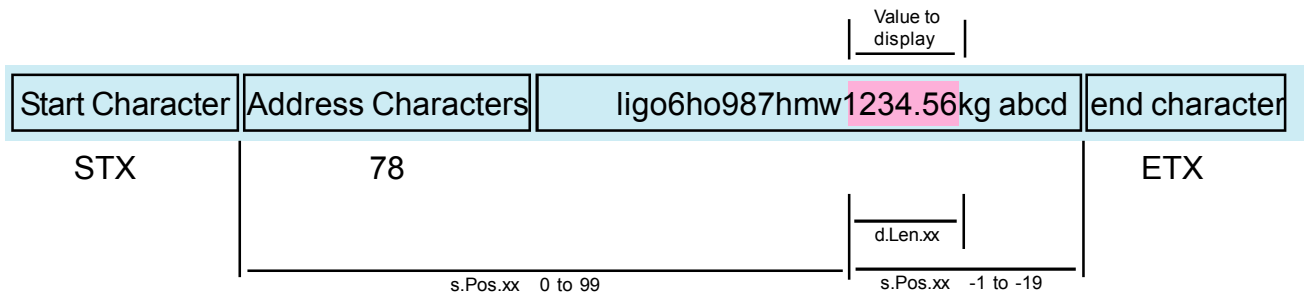

You would set...

```
ADDR.78, S.CHR.02, E.CHR.03, BAUD 1200, DF.8Y1,
T.REP.05, T.CHR.00, TO.03, S.POS.15, D.LEN.06,
DDDD.DD, DP.A
```

# Logic input functions

The three contact closure inputs on the rear of the meter have default functions which are:-

- Contact closure 1 = Tare
- Contact closure 2 = Peak/Valley display
- Contact closure 3 = Reset

You can re-assign these to include :HOLD, Nett/Gross value display, Memory page address 1,2 or 4 (only if Multi-memory MEM option is installed)

1

Set1  
**Digit**

Set2  
▲  
Max/Min

Output  
▼  
Reset

Alarms  
**OK**

**Lockout Switch must be OFF**

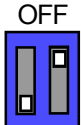

OFF

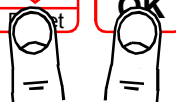

Press together briefly

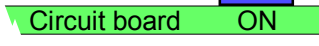

Circuit board ON

2

Set1  
**Digit**

Set2  
▲  
Max/Min

Output  
▼  
Reset

Alarms  
**OK**

Press repeatedly until you see **CC. 1**, followed by the existing function for Contact Closure 1.

After you have set **CC. 1**, you will get the prompt **CC. 2** to allow you to set Contact Closure 2 function and when you have set CC.2 you will get the prompt **CC. 3** to allow you to set Contact Closure 3 function



3

Set1  
**Digit**

Set2  
▲  
Max/Min

Output  
▼  
Reset

Alarms  
**OK**

Use UP or DOWN buttons to select from these available functions...

Defaults are:-

<b>CC. 1 = TARE</b>	<b>TARE</b> = Tare display to 0
<b>CC. 2 = PV</b>	<b>PV</b> = Peak/Valley toggle
<b>CC. 3 = RST</b>	<b>RST</b> = Reset
	<b>HOLD</b> = Freeze display
	<b>NET.GRO</b> = Nett / Gross display
	<b>PA. 1</b> = Page Address 1*
	<b>PA. 2</b> = Page Address 2*
	<b>PA. 4</b> = Page Address 4*

4

Set1  
**Digit**

Set2  
▲  
Max/Min

Output  
▼  
Reset

Alarms  
**OK**

**Done!**





Press to accept

\* Only available if the Multi-memory MEM option is installed

# Logic input connections and front buttons

The previous page explained how to select the functions of the 3 logic inputs. You can connect remote contact closures or open NPN collectors to activate these logic inputs.

The logic input provides a 5V DC signal. When you connect this to common, a current of 1mA will flow. Because this is a small signal, we recommend you use switches with gold plated contacts, or self cleaning contacts, for best long term reliability.

The logic inputs are not galvanically isolated from the input signal.

The logic inputs are only activated when the lockout switch is ON

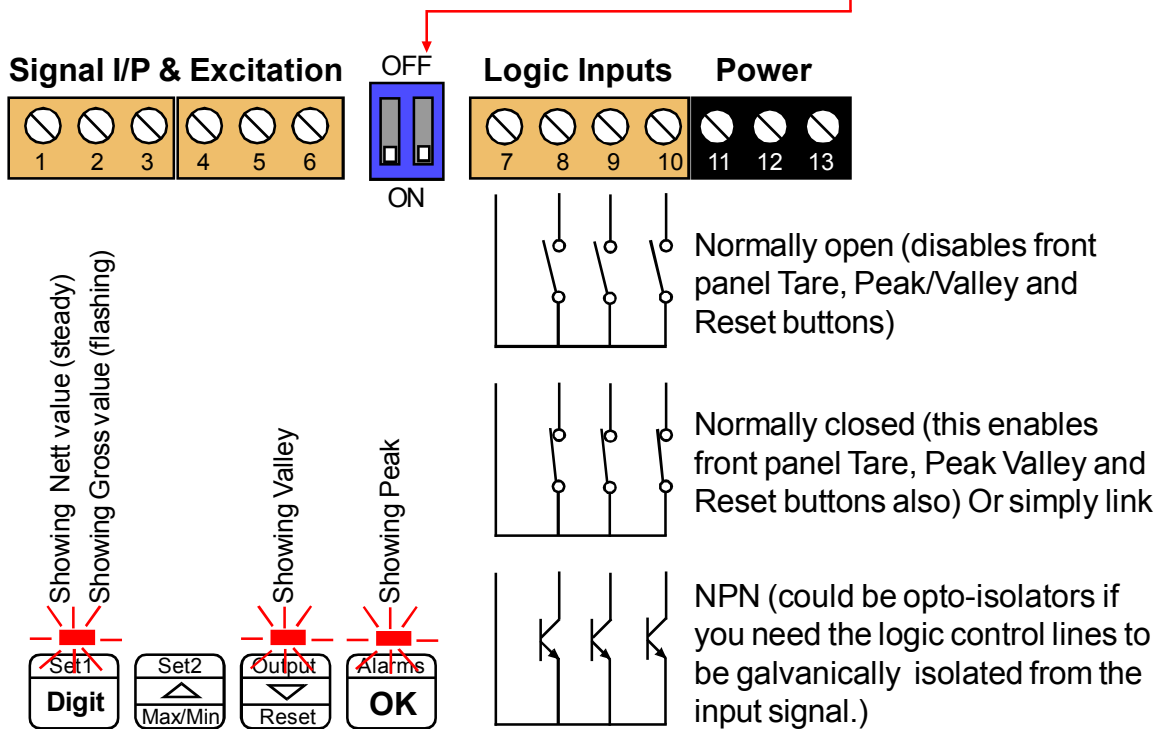

- TARE** = Tares display to 0. Often used in weighing systems to zero a display prior to making a measurement. Net weight is shown once tared. When a display has been tared the small LED above the Set1 button will be illuminated.
- PV** = Peak/Valley toggle. Allows you to view the maximum and minimum values which have been displayed since last reset. 0% LED illuminates when showing valley, 100% LED illuminates when showing peak.
- RST** = Reset. This clears any tare, peak, valley, alarm latch
- HOLD** = Freezes the displayed value for as long as the Hold input is closed
- NET.GRO** = Allows you to toggle between Nett and Gross values on the display
- PA. 1 .. 4** = Page Addresses, if MEM option is installed.

# Factory Defaults

You can return the display to its factory default conditions whenever you wish. If you do so, you will permanently lose all your settings and will need to start from the beginning again.

The calibration Audit Counter will NOT be reset, there is no way provided to reset this value, as it is intended as a secure record to indicate whether changes have been made to the display since it was last calibrated..

**1**

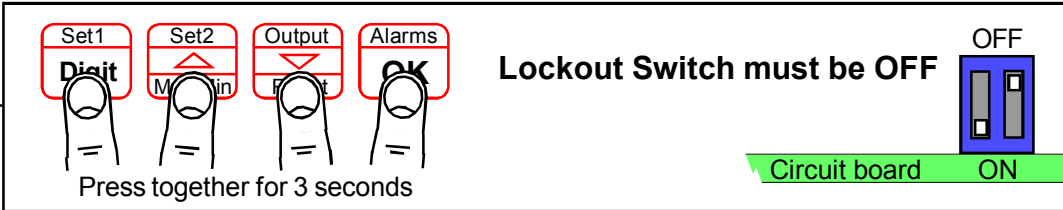

Set1 Digit Set2 Max/Min Output Reset Alarms OK

Press together for 3 seconds

Lockout Switch must be OFF

Circuit board ON

**2**

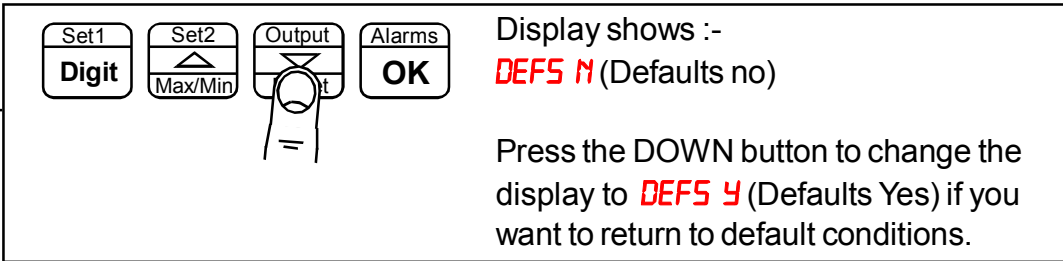

Set1 Digit Set2 Max/Min Output Reset Alarms OK

Display shows :-  
**DEFS N** (Defaults no)

Press the DOWN button to change the display to **DEFS Y** (Defaults Yes) if you want to return to default conditions.

**3**

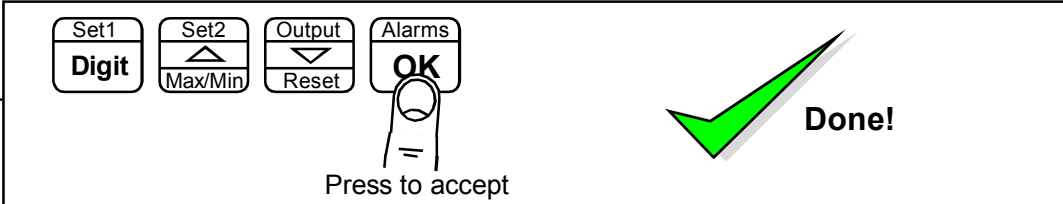

Set1 Digit Set2 Max/Min Output Reset Alarms OK

Press to accept

Done!

## Calibration audit number

Your display includes a non-resettable counter which increments each time you make a change to the display's calibration. This is useful if you want to check whether a display has been altered since it was last calibrated.

The Calibration audit number starts at **CAL 01** up to **CAL FF** allowing up to 255 alterations to be recorded. Whenever you want to check the calibration audit number, press and hold the 2 outer buttons (Set1 + Alarms) for more than 3 seconds.

**1**

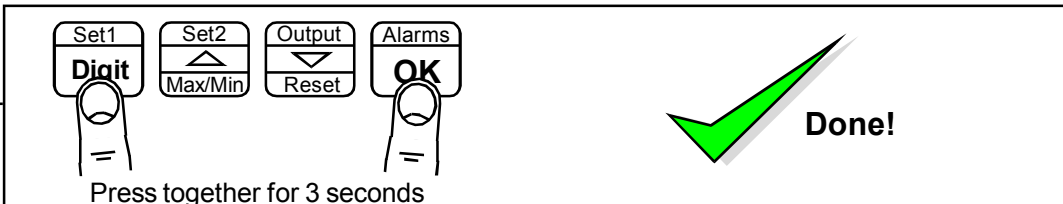

Set1 Digit Set2 Max/Min Output Reset Alarms OK

Press together for 3 seconds

Done!

# Scale Factor adjustment

After you have calibrated your meter, you can use the SCALE feature to make fine adjustments to calibration, without affecting the calibration itself. You must have mode = **QUANT**

## Examples

### 1. Changing weight units of measure from kg to pounds

You could also use the SCALE to convert your readout from kg to pounds, without affecting the calibration. Simply set SCALE = 2.205 and your meter which was calibrated in kg will now read in pounds.

### 2. Correcting for gravitational variance

Your weighing system was calibrated where gravitational acceleration =  $9.812\text{m/s}^2$  (London) You then move the system to Bangkok where gravitational acceleration is reduced to  $9.782\text{m/s}^2$

You can correct for this difference by setting Scale =  $9.812 / 9.782 = 1.003$ , so that a given mass in Bangkok will show the same weight as it did in London. Set Offset = 0.0000

See [http://en.wikipedia.org/wiki/Earth%27s\\_gravity](http://en.wikipedia.org/wiki/Earth%27s_gravity)

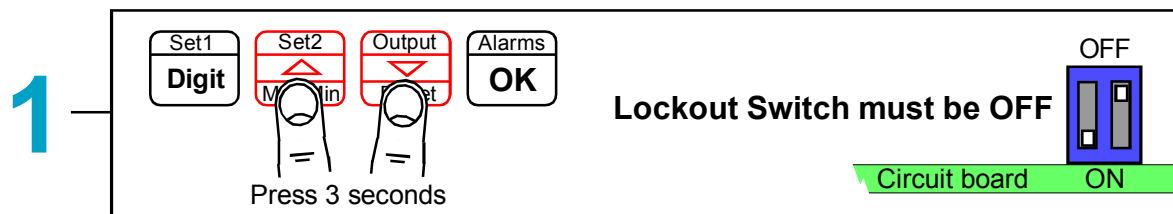
- 

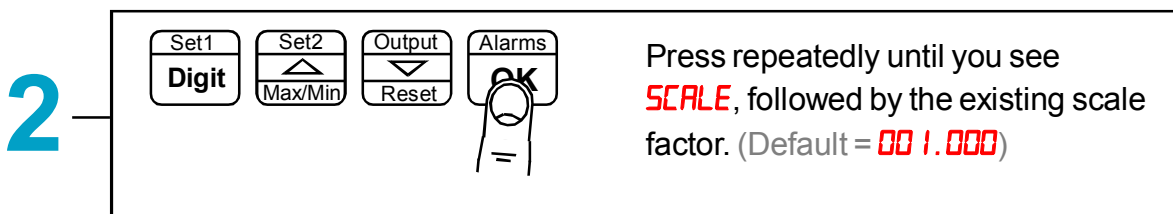
1 — Lockout Switch must be OFF
- 

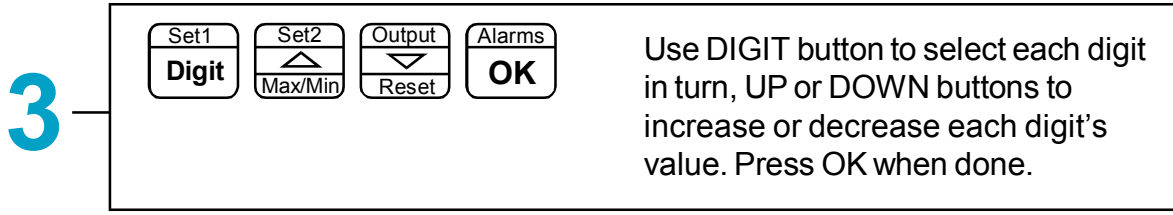
2 — Press repeatedly until you see **SCALE**, followed by the existing scale factor. (Default = **001.000**)
- 

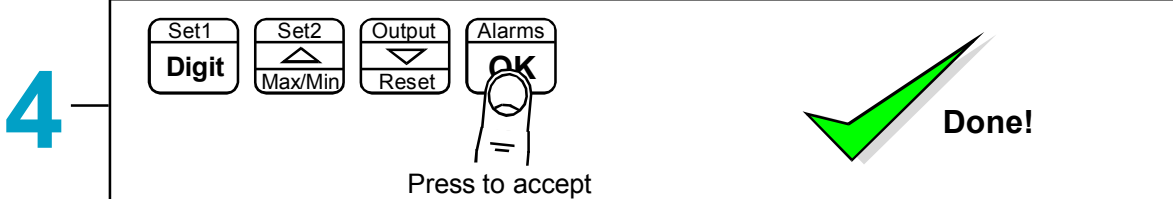
3 — Use DIGIT button to select each digit in turn, UP or DOWN buttons to increase or decrease each digit's value. Press OK when done.
- 

4 — Press to accept

Done!

You may want to adjust an offset value also, see separate OFFSET page for this feature.

# Offset adjustment

After you have calibrated your meter, you can use the **OFFSET** feature to make fine additions or subtractions to the reading, without affecting the calibration itself.

You must have mode = **QUANT**

For example if your weighing structure is altered after calibration and you want to subtract the effect of 37kg of extra metalwork which was welded to the hopper, you can easily do this by entering a value of -37 in the offset value.

**1**

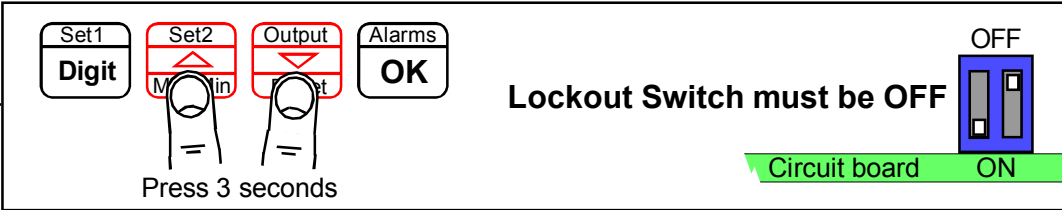

Set1 Digit Set2 Max/Min Output Reset Alarms OK

Press 3 seconds

Lockout Switch must be OFF

Circuit board ON

**2**

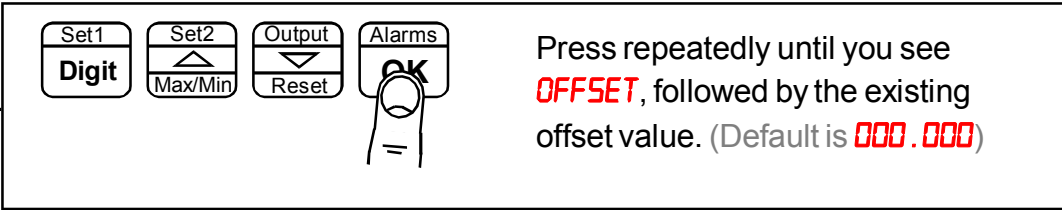

Set1 Digit Set2 Max/Min Output Reset Alarms OK

Press repeatedly until you see **OFFSET**, followed by the existing offset value. (Default is 000.000)

**3**

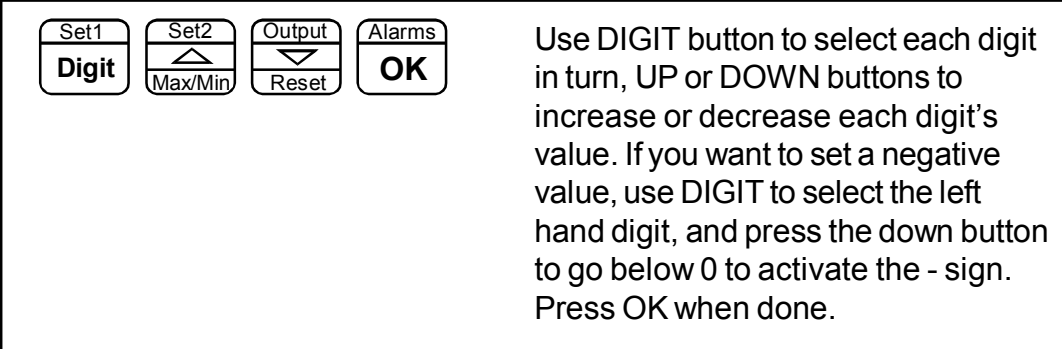

Set1 Digit Set2 Max/Min Output Reset Alarms OK

Use DIGIT button to select each digit in turn, UP or DOWN buttons to increase or decrease each digit's value. If you want to set a negative value, use DIGIT to select the left hand digit, and press the down button to go below 0 to activate the - sign. Press OK when done.

**4**

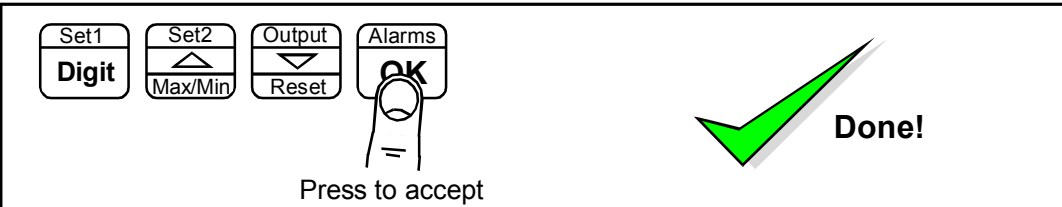

Set1 Digit Set2 Max/Min Output Reset Alarms OK

Press to accept

Done!

You may want to adjust a SCALE FACTOR value also, without affecting calibration. See the separate SCALE page for this feature.

# Menu timeout adjustment

The display has a default timeout of 60 seconds, to allow you sufficient time to refer to the manual between key operations.

You can make this period shorter, if you wish, once you become more familiar with the setup method.

**1**

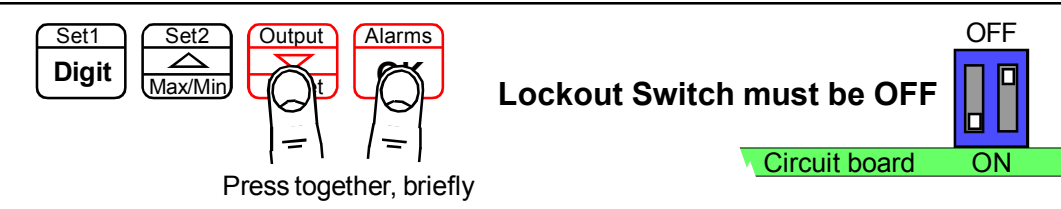

Set1 Digit   Set2 Max/Min   Output   Alarms

Press together, briefly

Lockout Switch must be OFF

Circuit board ON

**2**

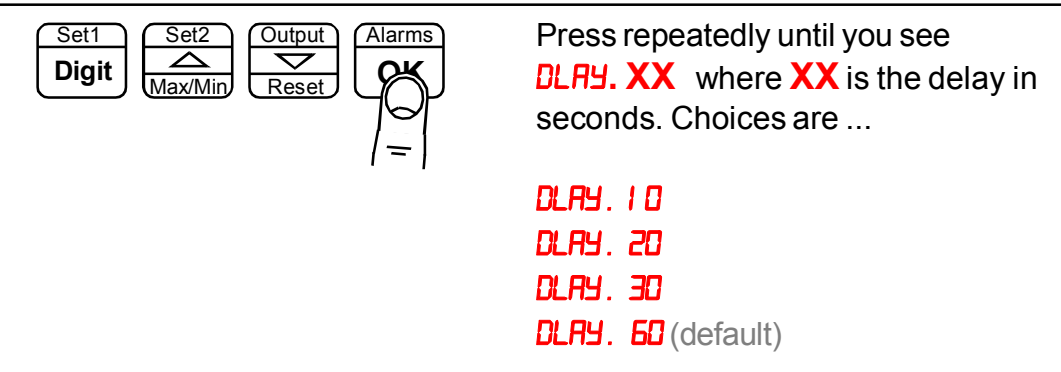

Set1 Digit   Set2 Max/Min   Output Reset   Alarms OK

Press repeatedly until you see **DLAY. XX** where **XX** is the delay in seconds. Choices are ...

**DLAY. 10**  
**DLAY. 20**  
**DLAY. 30**  
**DLAY. 60** (default)

**3**

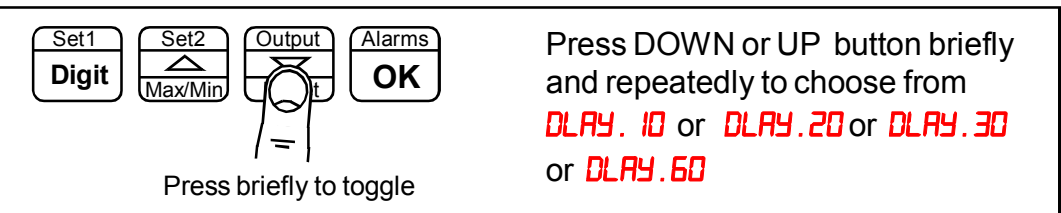

Set1 Digit   Set2 Max/Min   Output Reset   Alarms OK

Press briefly to toggle

Press DOWN or UP button briefly and repeatedly to choose from **DLAY. 10** or **DLAY. 20** or **DLAY. 30** or **DLAY. 60**

**4**

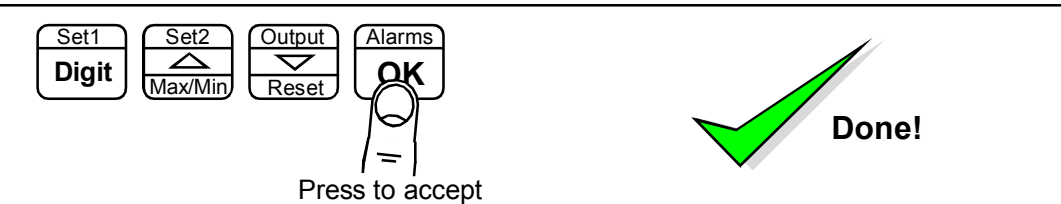

Set1 Digit   Set2 Max/Min   Output Reset   Alarms OK

Press to accept

Done!

# Reverse Display function (mirror image)

If you need to be able to see a reflection of the display in a mirror or other reflective surface, for example in a simple heads-up system, or for drivers reversing into a bay, using mirrors only, you can set the display to show as a mirror image.

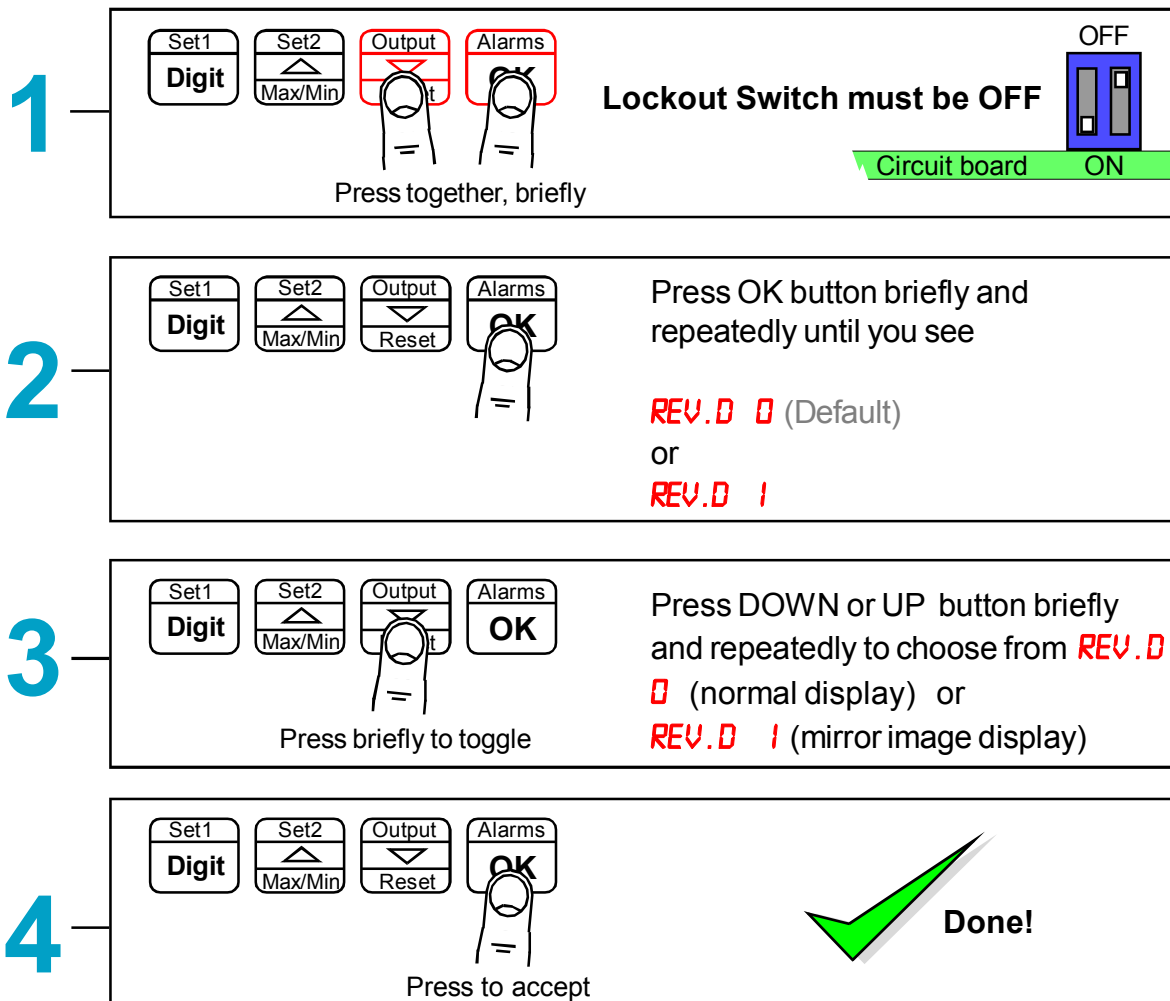

Example of normal display format displaying the number 876543



Example of Mirror Reverse display format displaying the number 876543



# Bootup routine choices

When you switch on your meter, it can be set to power up with 3 possible summary message combinations.

The choices are:-

- BOOT 0** = Segment test, followed by a full summary of software revision, calibration audit number, model number, installed options.
- BOOT 1** = Segment test followed by model number (Default)
- BOOT 2** = No summary, meter displays the measurement value immediately power is applied.
- BOOT 3** = All segments illuminate permanently, until a button is pressed

**1**

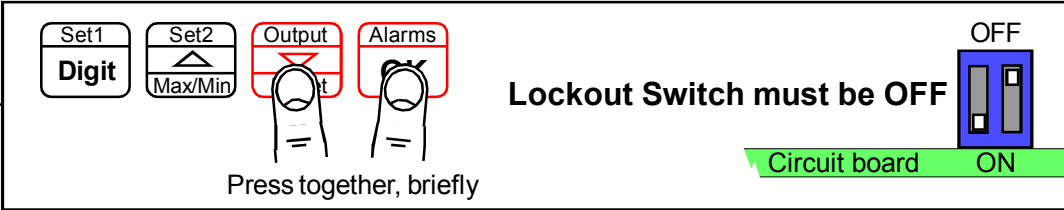

Set1 Digit Set2 Max/Min Output Alarms

Press together, briefly

Lockout Switch must be OFF

Circuit board ON OFF

**2**

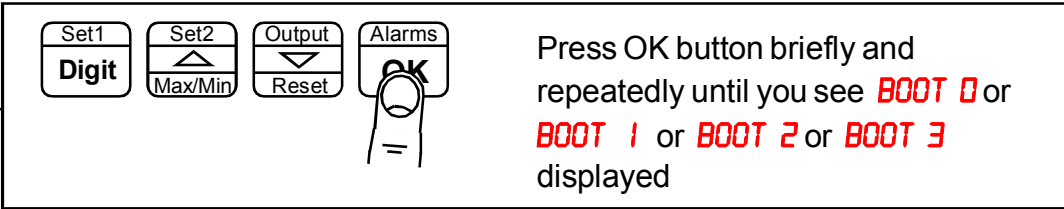

Set1 Digit Set2 Max/Min Output Reset Alarms OK

Press OK button briefly and repeatedly until you see **BOOT 0** or **BOOT 1** or **BOOT 2** or **BOOT 3** displayed

**3**

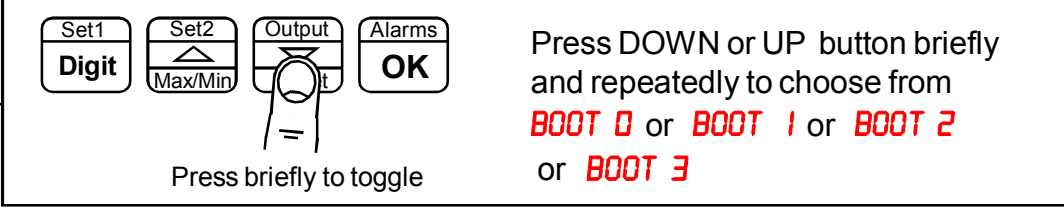

Set1 Digit Set2 Max/Min Output Alarms OK

Press DOWN or UP button briefly and repeatedly to choose from **BOOT 0** or **BOOT 1** or **BOOT 2** or **BOOT 3**

Press briefly to toggle

**4**

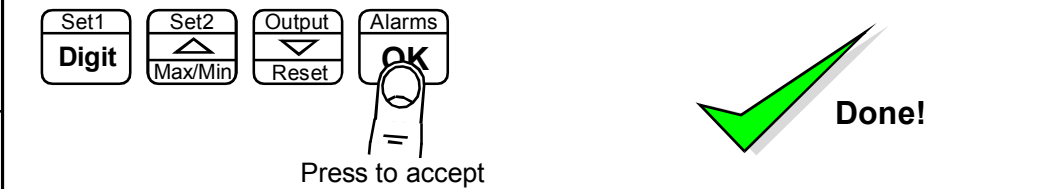

Set1 Digit Set2 Max/Min Output Reset Alarms OK

Press to accept

Done!



You can trigger the full summary message whenever you want, without having to power the meter off, by pressing and holding the 2 outer buttons (Set1 + Alarms) for more than 3 seconds.

# Multi-Program Memory option MEM

The three contact closure inputs on the rear of the meter may be used to call up between 1 to 7 additional meter setup memories (pages), if the MEM option has been installed. This allows you to save up to 8 complete sets of independent calibrations, alarm settings, analogue output settings and serial comms settings.

First decide how many memory pages you want, as this will determine how many logic inputs you will need to use for the addressing. Logic inputs not required for Page Addressing can be used for other functions such as Tare, Reset, Display Hold, Peak/Valley display.

If you have used all 3 logic inputs for Page Addressing, you can still use the meter's front panel buttons to perform Tare, Reset and peak/Valley view.

**See "Contact Closure Input Functions" page for CC.1, CC.2, CC.3 and COP settings**

Total number of pages	Logic Inputs required for addressing
1	none, standard single page meter
2	1 Set CC.1 = PA.1
3 or 4	2 Set CC.1 = PA.1, Set CC.2 = PA.2
5 to 8	3 Set CC.1 = PA.1, Set CC.2 = PA.2, Set CC.3 = PA.4

1. Set lockout switches OFF, and set page address to 0 or unplug the logic connector.
2. Set the copy instruction to **COP. 1** in page address 0 ( found after you set CC3) .
3. Press all 4 buttons together, display shows **DEFS. N**
4. Press the Up arrow to change display to **DEFS. Y** and press OK.
5. If you want all channels to share a common setting, eg calibration, do that setting now.
6. When you want to do separate settings for each channel, set COP.0

## Programming and recalling individual pages

Plug the logic input connector back in, if you removed it earlier. Select a page address using the switch combinations shown below, wired to the Logic Input connector ...

Page address 0	All logic inputs open
Page address 1	CC.1 closed to Common
Page address 2	CC.2 closed to Common
Page address 3	CC.1 and CC.2 closed to Common
Page address 4	CC.4 closed to Common
Page address 5	CC.1 and CC.3 closed to Common
Page address 6	CC.2 and CC.3 closed to Common
Page address 7	All logic inputs closed to Common

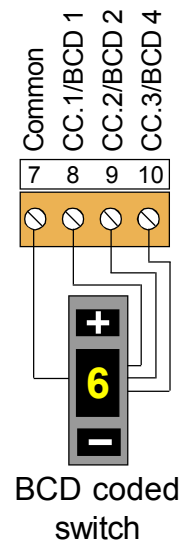

Perform the settings you require, according to the pages in this manual. Do this for all page addresses required. Then put the lockout switch in its ON position. Now, if you select a page address, the meter will briefly confirm the chosen page address on screen, and will then function according to the settings you programmed for that address.

Suitable BCD coded switches are available from many electrical supply stores. For example consider Kraus & Naimer part A540-600 E24 or Apem part number IRBC10N1248 or London Electronics part number SW2P-8W-BCD, which also provides separate 2 pole 8 way signal selection function.

# Error codes and fault finding



1. Display shows minus signs.

This tells us that there is no response to input data, either because....

- a) There is no data, and the display has timed out
- b) There is an error in the data wiring.
- c) One or more of the menu settings may be wrong.

You can test for a) and b) with a simple data monitor which you can make with 2 diodes and a resistor, as shown below.

The Green LED should be on for most of the time, and you should see the red LED flicker as data is sent.

If the red LED is lit most of the time, with the green flickering, your wiring may be transposed.

If neither LED is lit, check your data source to make sure it is configured to transmit continuously, and check your connections to make sure the cabling and connector terminals used are correct.

If the Green LED is on, but no flickering of the red is seen, check that the data source has been set to transmit permanently. If the data source is another London Electronics Display, make sure it has been set to mode C1 and that the enable terminal on the serial output connector is connected to data common.

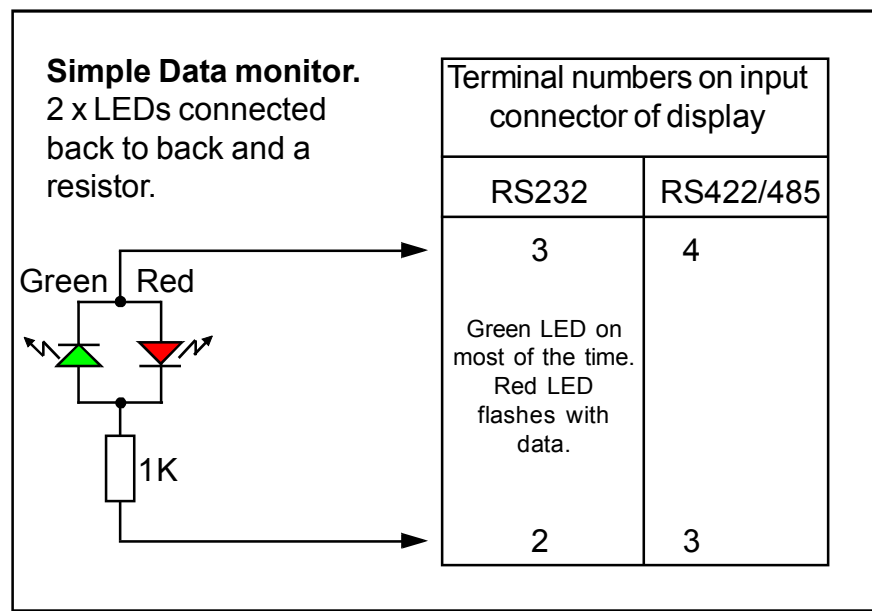

2. You can use your PC to generate and monitor serial data, with a free program called RealTerm which you can download from :-  
<http://sourceforge.net/projects/realterm/>

This can be very useful in diagnosing communication problems.

# How to install option boards



Where the product is intended for "UL" installations removal or addition of option boards is not permitted.



**Warning:** Disconnect power before you expose the rear of the meter

If you want to open your meter to install or modify option boards, follow these steps...

- 1) Switch off power to the meter and unplug all connectors.
- 2) Unclip the front bezel. This is easier if you squeeze the top and bottom of the case, near the front.
- 3) Remove the small screws shown in the diagram. If the meter doesn't yet have an output option board, the top screw may not yet be fitted.
- 4) Slide the electronic boards out through the front of the case. You can easily separate the upper option board from the main board. We strongly suggest that you use anti-static precautions to prevent damage to the semiconductors.

The board assemblies will look something like this...

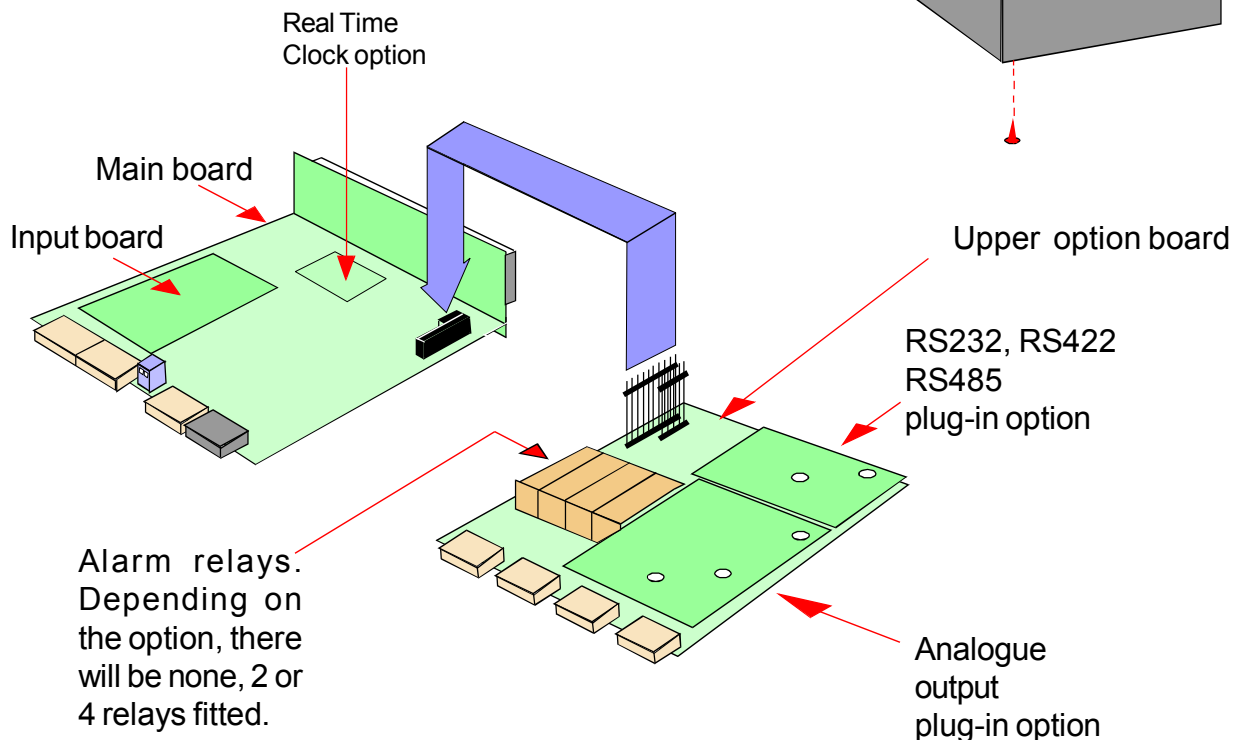

The analogue output and RS232 or RS422 plug-in option boards are fixed to the upper option board with white plastic pillars. You must apply a firm force when fitting or removing these options.

Always be careful to connect the pins to sockets accurately. When reassembling, make sure option boards are firmly fixed to the upper option board. When the boards are replaced in the case, secure them again with the two small black screws.

# Waste Electrical Electronic Equipment (WEEE)

In Europe, this equipment must be disposed of in accordance with European Parliamentary Directive 2002/96/EC

This directive encourages recycling and the reduction of waste materials in the environment.

This means it must be sent to an approved recycling plant if you want to dispose of it.

It must not be thrown away with general rubbish.



# WEEE Waste Recycling

If you are unable to dispose of this item locally, you may send it to us for recycling.

## Conditions:

1. We will only accept items of our manufacture.
2. You must pay for the transport of the goods to us.
3. We will only accept items if they include a signed declaration by an authorised person in your organisation, stating that :-
  - i. The item is safe to handle and has no contaminants which may be harmful to health.
  - ii. You wish us to dispose of or destroy the item(s)

# Equipment Specifications

<b>Bezel size</b>	72mm high by 144 mm wide
<b>Panel Cutout</b>	67.5 mm high by 138 mm wide
<b>Case Depth</b>	150 mm including connectors
<b>Weight</b>	450 grammes
<b>Case Material</b>	Black polycarbonate
<b>Connectors</b>	Detachable Screw Terminal connectors
<b>Environmental</b>	Storage Temperature range -20 to +70C, non condensing Operating temperature range 0 to 50C, non condensing Front sealed IP65. Optional cover SPC4 for IP67 Allow 30 minutes for the display to reach thermal equilibrium.
<b>Power Burden</b>	100-240 VAC, 45 to 60Hz or 11-30 VDC optional 10VA maximum
<b>Input Signals</b>	RS232 on model INT2-S2 RS422 and RS485 on model INT2-S4  Baud rate selectable from 300 to 115200 Data format selectable 701,7e1,7n2,80,8E,8n,8n2 Address 00 to FF Inter message delay time 00 to 99 mS Inter character delay time 00 to 99 mS
<b>Display update rate</b>	10 readings per second
<b>Display range</b>	-199999 to 999999

## Plug-In Output Options

<b>Analogue O/P</b>	See analogue output manual on our website for details.
<b>Alarm Relay O/P</b>	See alarm output manual on our website for details.
<b>ASCII Data O/P</b>	See serial output manual on our website for details.
<b>Calendar/Clock option</b>	See serial output manual on our website for details.

# Record of Revisions

1 May 2016	INT4 version released
22 September 2022	UKCA certification added

## ASCII Hex codes and displayed characters

20 space	37 7	48 H	52 R	62 B	6c L	76 V
2D -	38 8	49 I	53 S	63 C	6d M	77 W
2E .	39 9	4a J	54 T	64 D	6e N	78 X
30 0	41 A	4b K	55 U	65 E	6f O	79 Y
31 1	42 B	4c L	56 V	66 F	70 P	7a Z
32 2	43 C	4d M	57 W	67 G	71 Q	
33 3	44 D	4e N	58 X	68 H	72 R	
34 4	45 E	4f O	59 Y	69 I	73 S	
35 5	46 F	50 P	5a Z	6a J	74 T	
36 6	47 G	51 Q	61 A	6b K	75 U	

Other ASCII Hex codes and their characters are:-

Hex	Function	Hex	Function
02	STX	2c	,
03	ETX	2d	-
04	EOT	2e	.
0a	Line Feed	2f	/
0c	Form Feed	3c	<
0d	Carriage Return	3e	>
1b	Escape	5c	\
20	Space	5e	^
21	!	5f	_
25	%	60	'
26	&	7b	{
28	(	7c	
29	)	7d	}
2a	*	7e	~
2b	+	7f	DEL



## Signal levels

These examples show a single ASCII character 2C (0010 1100) which is a Comma, so that you can see the voltages in RS485 and RS232 systems.

### Typical UART output

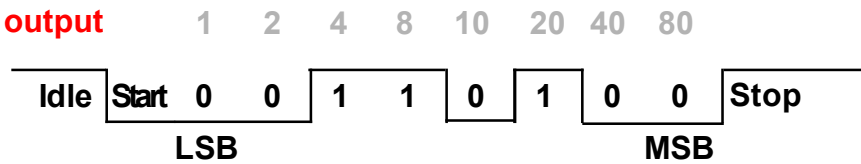

### RS485 data line levels 8n1

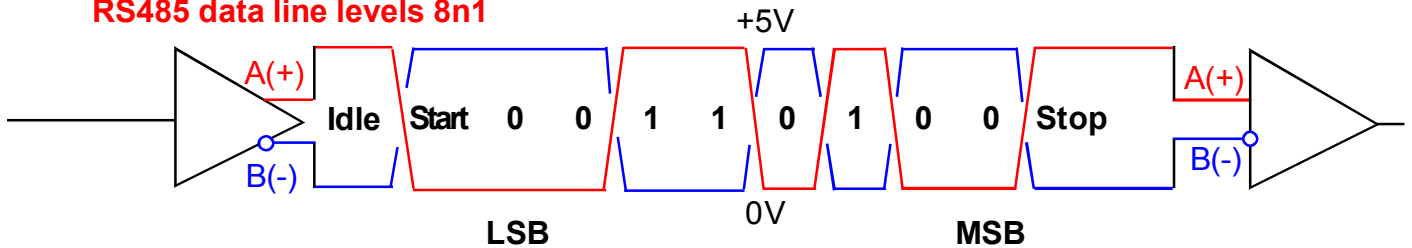

### RS232 data line levels 8n1

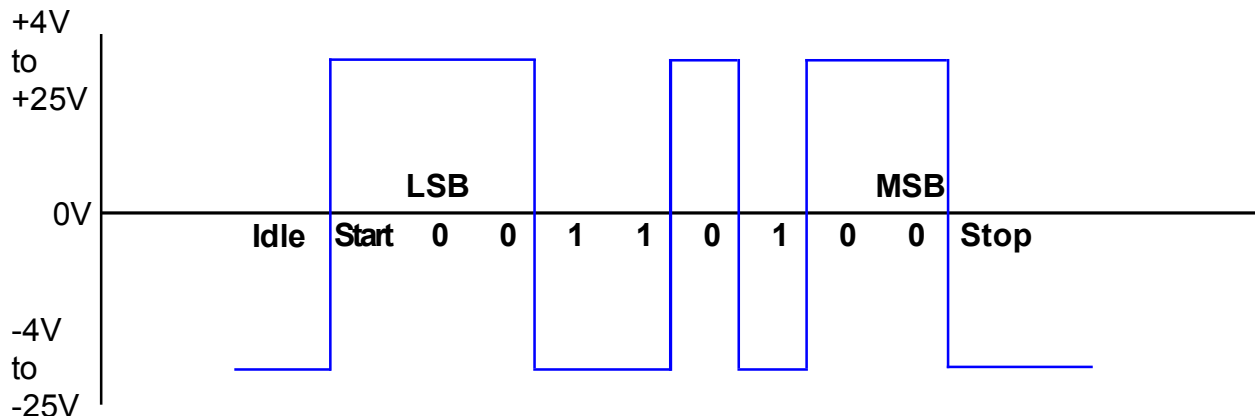

## Special data commands

These messages are not handled by the normal data parsing. If the escape character '~' is the first available character the whole message is treated as a command message.

Message format is: <S.Chr><Addr>~[Command]<E.Chr>.

Display Brightness Control '~Bx' where 'x' is 1(dim) to 8(bright)  
The brightness setting is not saved to non-volatile memory.

Clear display '~C' Clears display and indicators (meter looks like it's turned off)  
The display will return to its illuminated state on the next receipt of normal data.

Set/Clear Alarm Indicator '~Aas' where 'a' is the Indicator ID (0 to 3)  
where 's' is the state (0 or 1)  
When this command is received normal alarm indication is suspended until the meter is rebooted

# Application Note

## Connecting master and slave displays over RS232 or RS485

RS232 should be used over short distances only, preferably under 10 metres of cable length

RS485 can be used over cable lengths from 0 to over 1000 metres of cable length.

### RS232 Slave

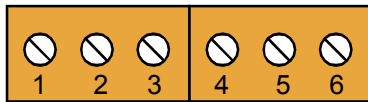

Demand  
Comm  
Rxd  
Txd  
nil  
nil

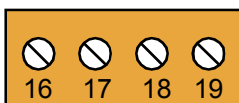
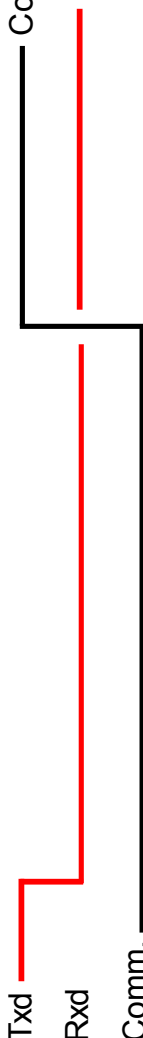

### RS232 Master

#### Input settings on slave

Mode = Quant  
 Addr.00  
 S.Chr.00  
 E.Chr.0d  
 bAud 1200  
 dF8n1  
 t.reP.05  
 t.Chr.00  
 to.03  
 S.POS.00  
 d.LEn.00  
 ddddd.  
 dP.A

#### Output settings on master

Baud 1200  
 dF.8n1  
 Prot.C1  
 Addr.00  
 t.rep.05  
 t.chr.00

### RS485 Slave(s)

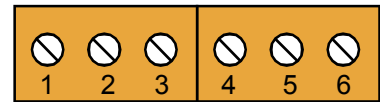

Demand  
Comm  
Data A+  
Data B-  
nil  
nil

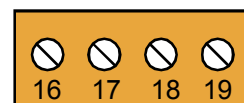
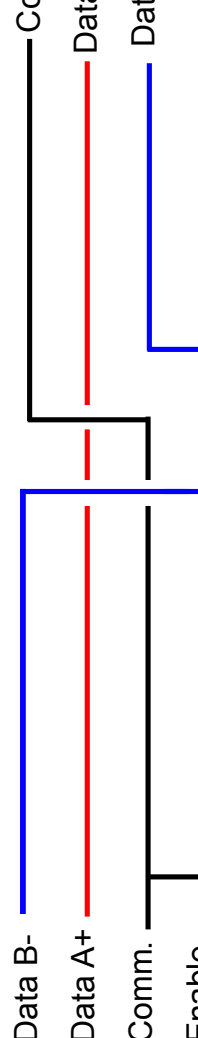

### RS485 Master

Refer to installation hints in the master and slave manuals, for guidance on cable types and screening.

# Declaration of UK & CE Conformity



Declaration Reference : INTUITIVE Mk4  
Issue Date : 20 September 2022  
Products Covered : INTUITIVE Mk4 series  
Title : DOC-INTUITIVE4

We hereby self-certify that the design and manufacture of this product conforms with the UKCA and CE standards, by complying with the directives and standards below.

Electrical Equipment (Safety) Regulations, 2016 and amendments  
Low Voltage Directive 2014/35/EU  
BS EN 61010-1 : 2010 + A1 : 2019

Electromagnetic Compatibility Regulations, 2016 and amendments  
EMC Directive 2014/30/EU  
EN 61326-1 : 2013  
Immunity for equipment intended to be used in an industrial electromagnetic environment.

Maximum errors of 1% of dynamic range are permitted.  
Instrument must recover automatically from disturbance.

Restriction of the Use of Certain Hazardous Substances in Electrical and Electronic Equipment Regulations, 2012 and amendments  
RoHS2 directive incorporating RoHS3 Amendment 2015/863/EU  
EN IEC 63000 : 2018

## Conditions

The meters are permitted a worst case error of 1% of A/D range during electro-magnetic disturbance, and must recover automatically when disturbance ceases without the need for human intervention, such as resetting, power-down etc.

The meters covered by this certificate must be installed in adherence to the following conditions :-

Signal cabling shall be routed separately to power carrying cabling (includes relay output wiring)

All signal cabling shall be screened. The screen shall only be terminated to the power earth terminal at the meter end of the cable.

Declared as true and correct, for and on behalf of London Electronics Ltd.

J.R.Lees Director

We design and manufacture a wide range of standard and custom monitoring and control equipment.

All our UK manufactured products have a 3 year warranty.

### Real-Time Production-Line Displays



### Large Digital Displays sealed IP65



### Digital Panel Meters



### Power Monitors



### Bargraph Displays



### Message Displays sealed IP65

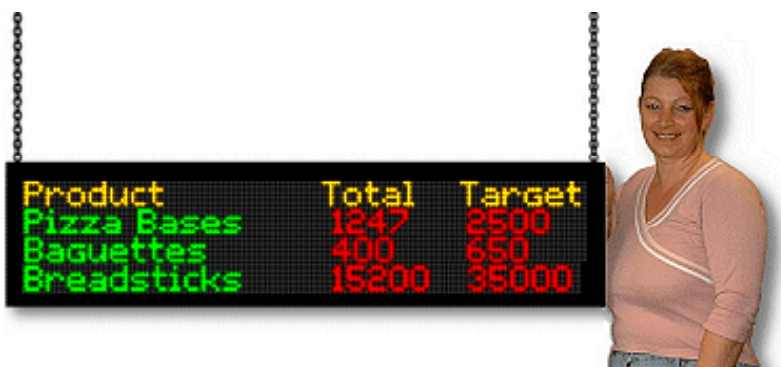

### Signal Transmitters / Isolators

