



CE UK
CA

FUSION

Large 6 Digit Clock / Timer Display



Model FUSION-H

Installation & Operating Manual Revision 26

Caution: There is a risk of electrical shock if this instrument is not properly installed



Caution: Risk of danger: Read the whole manual before you install this meter



London
Electronics
Limited

www.london-electronics.com

Table of Contents

Warranty	1
Warnings	2
Introduction.....	3
General Description	4
Suspension Mounting Dimensions.....	5
Wall Mounting Dimensions.....	6
Panel Mounting Dimensions	7
Connections.....	8
Connections.....	9
Installation Hints For Best Performance	10
Easy or Advanced Menu Mode.....	12
Display Brightness	13
Modes Setting.....	14
Basic Clock Configuration.....	15
Timer Mode Settings	16
RTC Setup Method	17
Factory Defaults	18
Calibration Audit Number	18
Logic Input Functions	19
Logic Input Connections & Front Buttons	20
Menu Timeout Adjustment.....	21
Reverse Display Function (Mirror Image)	22
Bootup Routine & Tare Save Choices	23
Language Selection for User Interface.....	24
Error Codes & Fault Findings.....	25

How To Install Option Boards26

Waste Electrical Electronic Equipment (WEEE)27

Equipment Specifications.....28

Record of Revisions.....29

Notes.....30

Declaration of UK & CE Conformity.....31

Warranty

We warrant this product against defects in materials or workmanship for a period of three (3) years from the date of purchase.

In the event of a defect during the warranty period, the unit should be returned, freight (and all duties and taxes) prepaid by the Buyer to the authorised distributor from where the unit was purchased.

The Distributor, at its option, will repair or replace the defective unit. The unit will be returned to the Buyer with freight charges prepaid by the distributor.

LIMITATION OF WARRANTY

The foregoing warranty shall not apply to defects resulting from:

1. Improper or inadequate maintenance by the buyer.
2. Unauthorised modification or misuse.
3. Operation outside the environmental specification of the product.
4. Mishandling or abuse.

The warranty set forth above is exclusive and no other warranty, whether written or oral is expressed or implied. We specifically disclaim the implied warranties of merchantability and fitness for a particular purpose.

EXCLUSIVE REMEDIES

The remedies provided herein are the buyer's sole and exclusive remedies.

In no event shall we be liable for direct, indirect, incidental or consequential damages (including loss of profits) whether based on contract, tort or any other legal theory.

Warnings

Please carefully read this manual and all warnings. Install the meter ONLY when you are sure that you've covered all aspects.



Where the product is intended for "UL" installations, removal or addition of option boards is not permitted.



Check that the model number and supply voltage suit your application before you install the meter.



Connect the meter according to current IEE regulations, IEC61010 & NFPA:70 National Electric Code in USA.



Power supplies to this equipment must have anti-surge (T) fuses rated at 400mA for 230V supply, 400mA for 110V supply or 2A for DC supplies in the range 11-30VDC.



Don't touch any circuitry after you have connected the meter, because there may be lethal voltages on the circuit board.



Do not apply power to the display if its case is open.



Only adjust on-board switches or connections with the power turned off.



Make sure all screw terminals are tight before you switch the meter on.



Only clean the meter's front with a soft damp cloth. Only lightly dampen with water. Do not use any other solvents.

Rear case screws - please note

The rear panel is held in place with socket flange button head screws, which only need to be gently tightened, with the supplied 2mm hex key.

Do not use tools to tighten or loosen the screws, as this could cause damage to the internal threads.

Introduction

Please contact us if you need help, if you have a complaint, or if you have suggestions to help us improve our products or services.

If you contact us about a product you already have, please tell us the full model number and serial number, so that we can give you accurate and fast help.

This product has a 3 year warranty. We will put right or replace any meter which is faulty because of bad workmanship or materials.

This warranty does not cover damage caused by misuse or accident. If you return a unit for repair, you must fill in the RMA form on our website, please include a detailed description of the problem, and the name of a contact who we can refer to for any questions. Please mark for the attention of the QA Department.

We always try to improve our products and services, so these may change over time. You should keep this manual safely, because future manuals, for new designs, may not describe this product accurately.

We believe these instructions are accurate, and that we have competently designed and manufactured the product, but please let us know if you find any errors.

General Description

This series of displays accepts industrial sensors to allow various physical measurements to be made, such as weight, temperature, pressure, humidity etc. Different models are available for different sensor types.

The main function of this series is to give a numeric readout of the variable being monitored. Most models include an excitation power output, to power the sensor directly.

Various digit heights are available, to suit the maximum viewing distance required in each installation.

Various optional output modules are also available to give alarm relay outputs, analogue output or digital communications, or any combination of these options.

Displays are programmed using front panel push buttons. The front panel buttons can be disabled. In addition, you can connect 4 remote wired push buttons to the display, so that you can make adjustments while the display is mounted in an inaccessible location.

Power supply options : 95-265V AC, 48V AC or 11-30VDC

These displays must be installed fully assembled, and must be installed according to local electrical installation rules.

When properly installed, and provided they have been ordered with cable glands exiting the lower surface of the case, they provide ingress protection to IP65 / NEMA4X from all directions.

Safety



Caution: There is a risk of electrical shock if this instrument is not properly installed



Caution: Risk of danger: Read the whole manual before you install this meter

Obey all safety warnings in this manual, and install the meter according to local wiring and installation regulations. Failure to follow these guidelines may cause damage to the meter, connected equipment, or may be harmful to personnel.

Any moving mechanical device controlled by this equipment must have suitable access guards to prevent injury to personnel if the meter should fail.

Suspension Mounting Dimensions

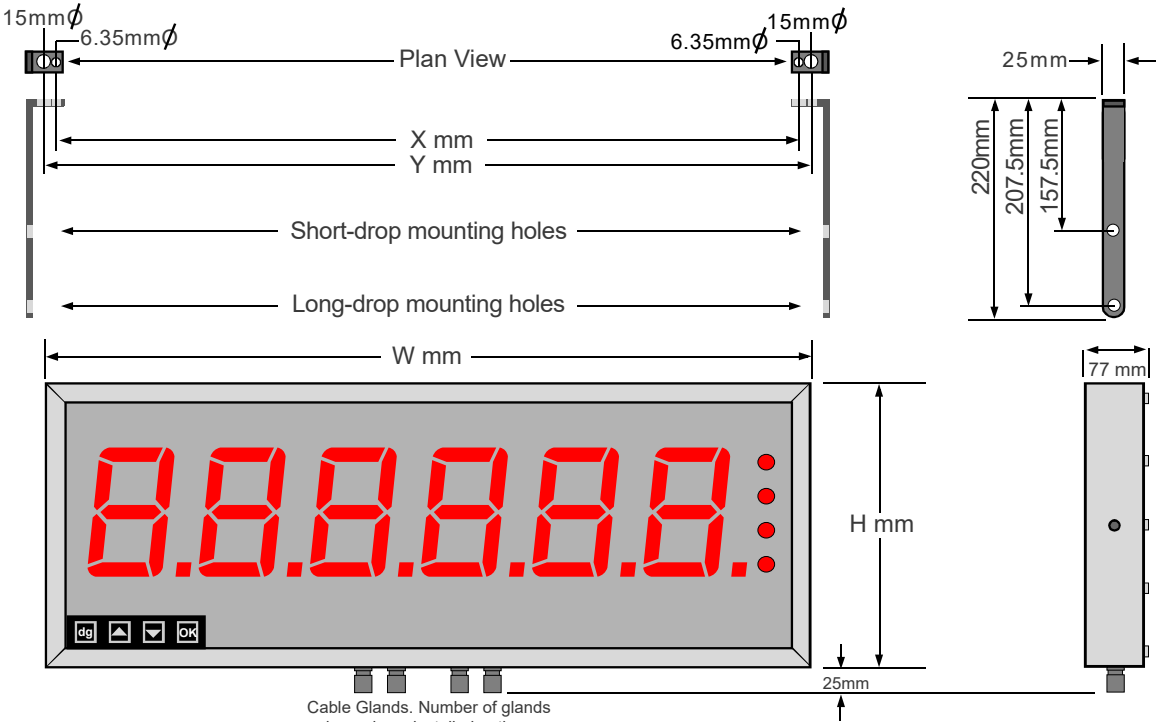

Detail showing bracket hardware fitting sequence

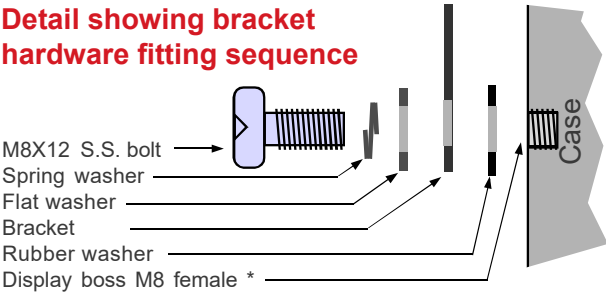

You can order these displays with the cable glands in the bottom surface (as shown) the rear, or top.

Rear glands allow you to mount the display on top of a cubicle, using the brackets shown.

*** Do not use longer bolt threads than 12mm , or you will fracture the female boss and the case will no longer be sealed.**

Display Format	X mm	H mm	W mm	Y mm
2" 4 digit numeric	219.5	154.5	279.5	249.5
2" 6 digit numeric	316	154.5	376	346
4" 4 digit numeric	374	195.5	434	404
4" 6 digit numeric	556	195.5	616	586
6" 4 digit	520	246	580	550
6" 6 digit	760	246	820	790
8" 4 digit	690	290	750	720
8" 6 digit	1012	290	1072	1042
12" 4 digit	990	408	1050	1020
12" 6 digit	1480	408	1540	1510
16" 4 digit	1308	515	1368	1338
16" 6 digit	1960	515	2020	1990

Wall Mounting Dimensions

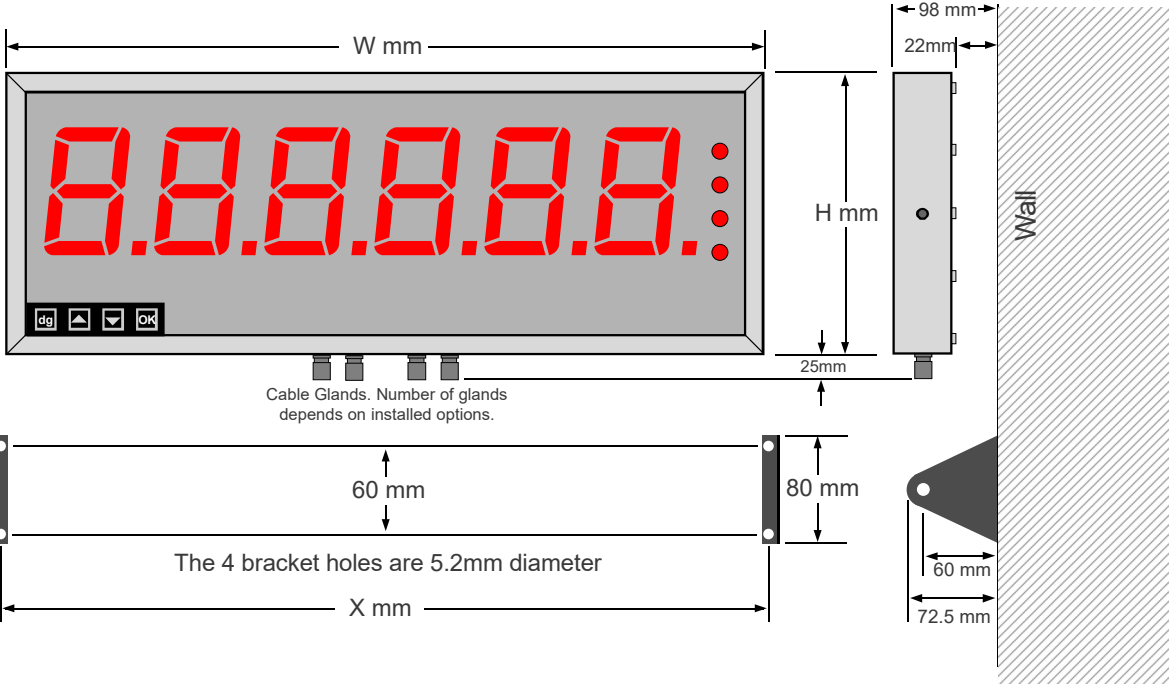

Detail showing bracket hardware fitting sequence

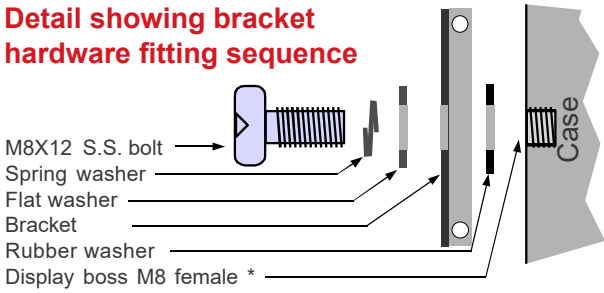

You can order these displays with the cable glands in the bottom surface (as shown) the rear, or top.

Rear glands allow you to mount the display on top of a cubicle, using the brackets shown.

*** Do not use longer bolt threads than 12mm , or you will fracture the female boss and the case will no longer be sealed.**

Display Format	X mm	H mm	W mm
2" 4 digit numeric	266.5	154.5	279.5
2" 6 digit numeric	363	154.5	376
4" 4 digit numeric	421	195.5	434
4" 6 digit numeric	603	195.5	616
6" 4 digit	567	246	580
6" 6 digit	807	246	820
8" 4 digit	737	290	750
8" 6 digit	1059	290	1072
12" 4 digit	1037	408	1050
12" 6 digit	1527	408	1540
16" 4 digit	1355	515	1368
16" 6 digit	2007	515	2020

Panel Mounting Dimensions

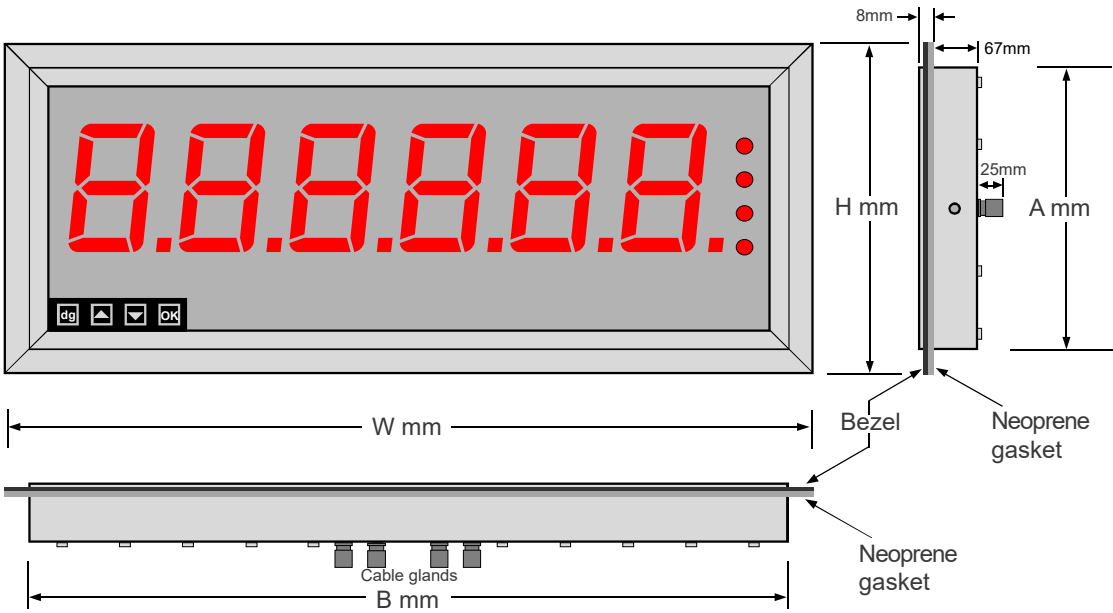

Detail showing bracket hardware fitting sequence

Panel cutout dimensions
 $A+3\text{mm}(h) \times B+3\text{mm}(w)$

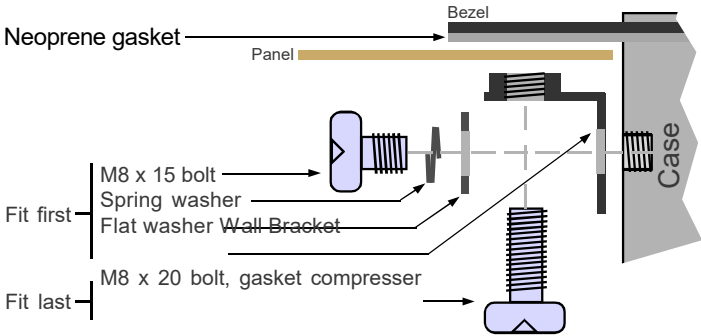

Display Format	H mm	A mm	B mm	Wmm
2" 4 digit numeric	172.5	154.5	279.5	297.5
2" 6 digit numeric	172.5	154.5	376	394
4" 4 digit numeric	213.5	195.5	434	452
4" 6 digit numeric	213.5	195.5	616	634
6" 4 digit	264	246	580	598
6" 6 digit	264	246	820	838
8" 4 digit	308	290	750	768
8" 6 digit	308	290	1072	1090
12" 4 digit	426	408	1050	1068
12" 6 digit	426	408	1540	1558
16" 4 digit	533	515	1368	1386
16" 6 digit	533	515	2020	2038

Connections



Warning:
Disconnect all power before removing the rear of the display

There is a wide range of possible locations for the input board, output board and power supply board/s. Their locations depend on the height of digits, number of digits, brightness of digits and any installed options. Because the permutation of possible locations is large, we will not describe the location of boards within the display, but simply identify the connectors and their functions on each board, below ...

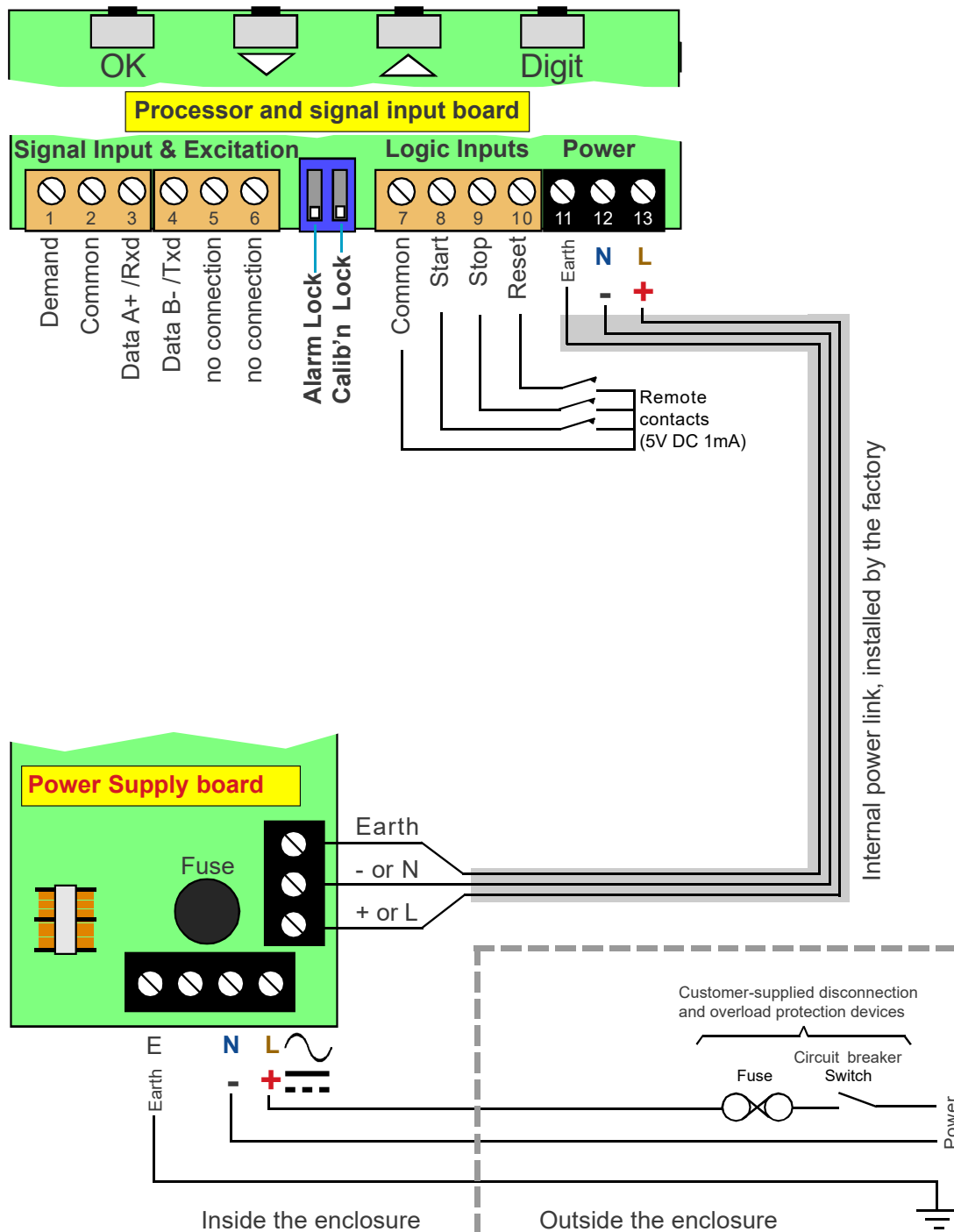

Connections

Warning:
Disconnect all power before removing the rear of the display

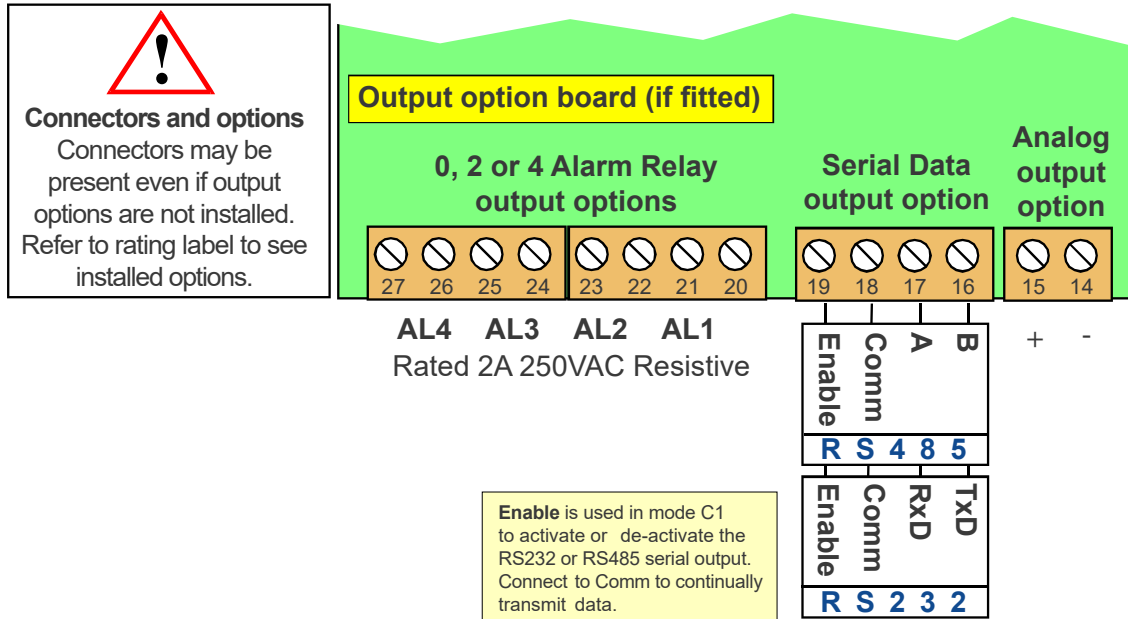

Remote programming button connector

On one of the display boards, you will find a 7 way connector, to which you can wire remote programming buttons, to allow adjustment of the display's settings when the display is inaccessible.

You can also enable or disable the display's front panel buttons, either by a remote contact closure, or by an on-board push-on jumper switch, which is located near to the remote button connector. When the contact is closed, or the push-on switch fitted, the front buttons are enabled.

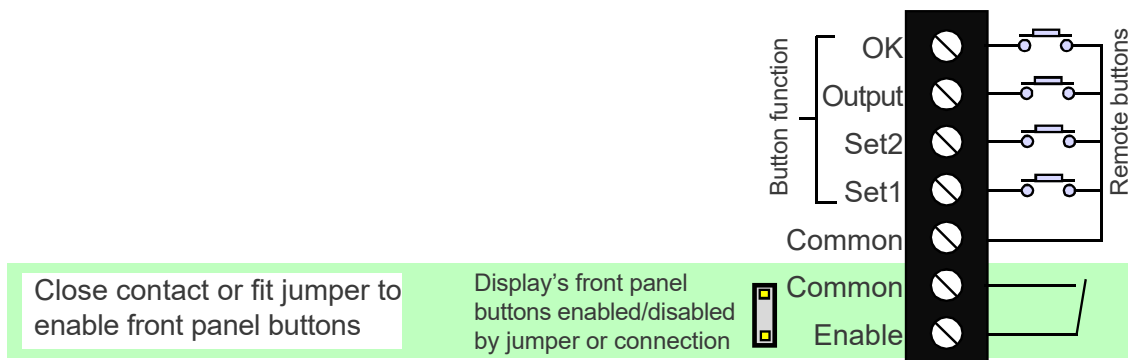

Rear case screws - please note

The rear panel is held in place with socket flange button head screws, which only need to be gently tightened, with the supplied 2mm hex key.

Do not use tools to tighten or loosen the screws, as this could cause damage to the internal threads.

Installation Hints For Best Performance

This section offers several suggestions which will help you get the best performance from your measurement system.

The logic input signals are comparatively small and can easily be corrupted by the comparatively high level of electrical noise which can be created by electrical machinery such as motors, welding systems, discharge lighting, AC power inverters and solenoids. These steps will ensure you get the best possible performance from your system.

1. Use good quality screened signal cable, with twisted pairs. Belden 8777NH, Belden 9503 and AlphaWire 6010C are good choices, available from many electrical distributors.
2. If you are using multi-pair twisted cable, each pair should be dedicated to a single display as shown opposite, for maximum noise immunity. This will ensure that any electrical noise induced in the cable is properly cancelled. Mixing destinations carelessly amongst the twisted pairs can worsen noise performance.
3. The cable should be routed away from noisy wiring and devices such as power feeds from inverters, discharge-lighting cables, welder cabling etc, and should preferably be routed in a dedicated low-voltage signalling/instrumentation conduit or cable tray.
4. Screened cable should be earthed at the display end only.
5. All wires and screens coming out of the screened cable should be kept as short as possible to minimise pickup of noise.
6. If you are using barriers, you should earth your screen as shown below, paying particular care that you do not earth both ends of any run of cable.

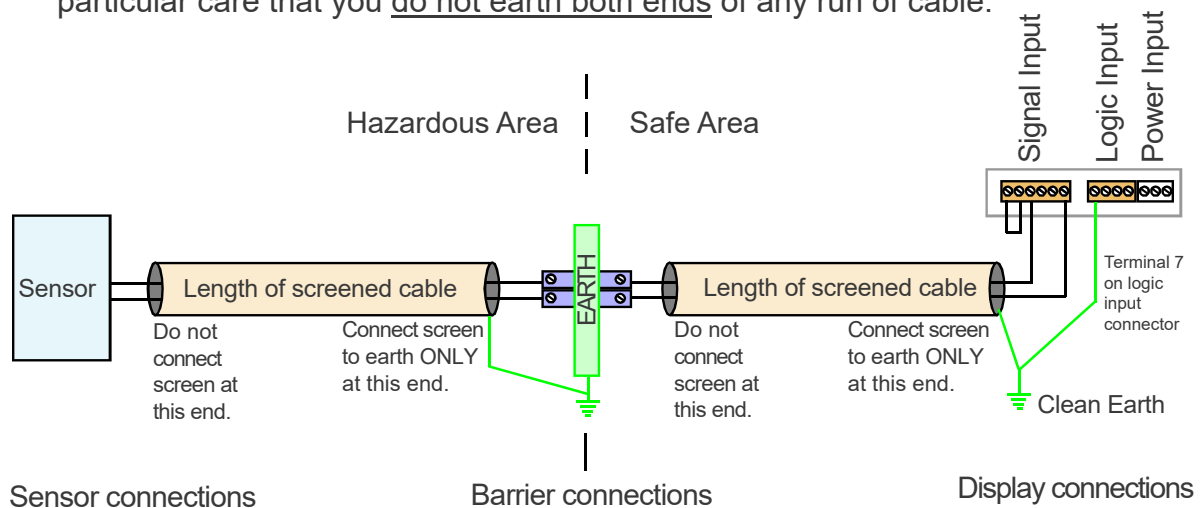

When using multi-core screened cable to connect several displays to several sensors, please be sure to use one twisted pair for each display and sensor.

Do NOT use a wire from one pair for signal positive and a wire from another pair for signal negative, as this will prevent the twisted cables from cancelling any induced electrical noise.

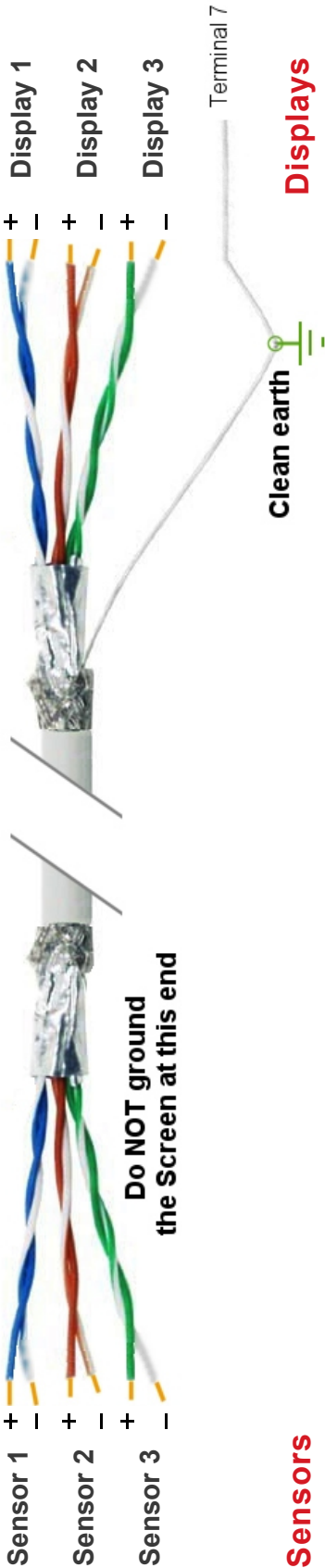

Easy or Advanced Menu Mode

You can choose from two menu modes.

1. Easy Mode - This limits the menu to the most commonly required features, in order to make it less complex and easier to navigate. This is the default level.

2. Advanced Mode - This gives you access to all available menu features.



Each menu feature in this manual has a heading note to tell you whether it is available in Easy or Advanced mode.

This feature is available in Easy and Advanced Modes

1

Set1 Digit Set2 Max/Min Output Alarms

Press together briefly

Lockout Switch must be OFF

Circuit board ON

2

Set1 Digit Set2 Max/Min Output Reset Alarms OK

Press briefly

Press OK a few times, until you see **ADV.** or **EASY**

3

Set1 Digit Set2 Max/Min Output Alarms OK

Press to toggle

Each press of the DOWN arrow, or UP arrow will alternate between showing **ADV.** or **EASY**

4

Set1 Digit Set2 Max/Min Output Reset Alarms OK

Press to accept

Press OK to select your choice.

Done!

Display Brightness

You can adjust the display brightness at any time, provided the display is locked.

1

Set1
Digit

Set2
Max/Min

Output
Reset

Alarms
OK

Lockout Switch must be ON

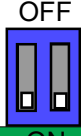

Circuit board ON



Press 3 seconds

2

Set1
Digit

Set2
Max/Min

Output
Reset

Alarms
OK

Display shows **BRIL**

Each press of the UP button will select a new brightness level. There are 7 brightness levels to choose from. (Default = Full brightness)



Press for 3 seconds

3

Set1
Digit

Set2
Max/Min

Output
Reset

Alarms
OK

Done!

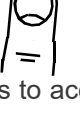

Press to accept



Did you know, we make this display in two brightness versions? Standard brightness for use inside, and Daylight Viewing for use outside in direct sunlight. The Daylight Viewing version has suffix -DLV in its part number.

Modes Setting

The display's calendar and internal clock will need to be set whenever the battery is renewed, and the clock may need to be set from time to time, if it is not synchronised to a master time source, such as our NTP upgrade.

This feature is available in Easy and Advanced Modes

1

Set1 Digit Set2 Max/Min Output Reset Alarms OK

Lockout Switch must be OFF

Circuit board ON

Press together for 3 seconds

2

Set1 Digit Set2 Max/Min Output Reset Alarms OK

Display shows the available modes

CL.	Clock Mode
DD.MM.YY	Calendar Mode - dd:MM:yy
MM.DD.YY	Calendar Mode - MM:dd:yy
DAY.CNT	Timer Mode - Days
HH.MM	Timer Mode - HH:MM
MM.SS	Timer Mode - MM:SS
SSSS	Timer Mode - SSSS
SSSSS.T	Timer Mode - SSSSS.t
MMMM	Timer Mode - MMMM
HH.MM.SS	Timer Mode - HH:MM:SS

3

Set1 Digit Set2 Max/Min Output Reset Alarms OK

Press to accept

Done!

Basic Clock Configuration

If the display is being used in **Clock Mode**, the following basic configurations will be available

This feature is available in Easy and Advanced Modes

1

Set1 Digit Set2 Max/Min Output Reset Alarms OK

Press 3 seconds

Lockout Switch must be OFF

Circuit board ON

2

Set1 Digit Set2 Max/Min Output Reset Alarms OK

Press to scroll through the available mode choices and press OK to select.

Display shows input channel choices...

Display format...

24HR (leading zeros 9am shows 09:00)
12HR (no leading zeros 9am shows 9:00)

Daylight saving time modes...

DST **OFF** **US** **EU**
 None USA Europe

Display sequencing dwell times...

C 00.0 Clock visibility time (seconds)
T 00.0 Temperature visibility time (seconds)
H 00.0 Humidity visibility time (seconds)

3

Set1 Digit Set2 Max/Min Output Reset Alarms OK

Press to accept

Done!

Timer Mode Settings

If the display is being used in Timer Mode, the following basic configurations will be available

This feature is available in Easy and Advanced Modes

1

Press 3 seconds

Lockout Switch must be OFF

Circuit board ON

2

Press to scroll through the available mode choices and press OK to select.

Display shows input channel choices...

Counting direction...
UP Up counting, normally from zero
DN Down counting, normally from preset

Down Count, action on reaching 0
NEG.Y Display will go below 0 on down count
NEG.N Display will stop at 0 on down count
 Display will flash if negative.

Offset adjustments
PRESET
 Display goes to this value whenever it is reset, and the display will normally count down from this value to 0

PR.LOAD
 If a period has already elapsed, when the display is installed (For example you are installing the display to show Days since last Accident and so far there have been 349 days without accident, you would set Pr.Load to 349) you can enter this value here. When the display is reset, the display will go to 0

3

Press to accept

Done!

RTC Setup Method

The display's calendar and internal clock will need to be set whenever the battery is renewed, and the clock may need to be set from time to time, if it is not synchronised to a master time source.

This feature is available in Easy and Advanced Modes

1

Set1 Digit, Set2 Max/Min, Output Reset, Alarms OK

Lockout Switch must be OFF

Circuit board ON

Press together for 3 seconds

2

Set1 Digit, Set2 Max/Min, Output Reset, Alarms OK

Display shows each of the parameters and you can move on to the next one with the OK button. Edit settings with the DIGIT, UP and DOWN buttons, OK to accept. Let us assume it is March 24, 2011. If the time will soon be 14:59 you will set ...

YR. 11	Set the last 2 digits of the year
M ~03	Set the month. 1=Jan, 12 = Dec
DT .24	Set the date 1=1st , 31=31st
14:59	Set the hour (must be GMT or UTC)*
14:59	Set the minutes
14:59	The time will brighten and the 4 leds to the right of the display will flash. At exactly 14:59, press the OK button. No menu timeout.

3

Set1 Digit, Set2 Max/Min, Output Reset, Alarms OK

Press to accept

Done!

Factory Defaults

You can return the display to its factory default conditions whenever you wish. If you do so, you will permanently lose all your settings and will need to start from the beginning again.

The calibration Audit Counter will NOT be reset, there is no way provided to reset this value, as it is intended as a secure record to indicate whether changes have been made to the display since it was last calibrated..

1

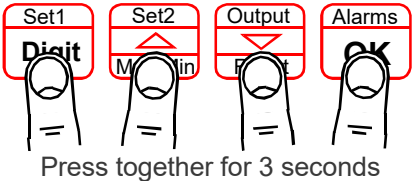

Press together for 3 seconds

Lockout Switch must be OFF

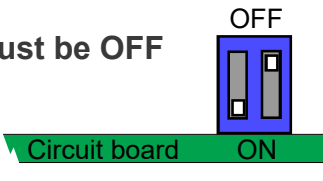

2

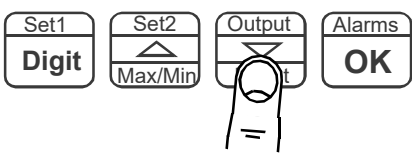

Display shows :- **DEF.N** (Defaults no)

Press the DOWN button to change the display to **DEF.Y** (Defaults Yes) if you want to return to default conditions.

3

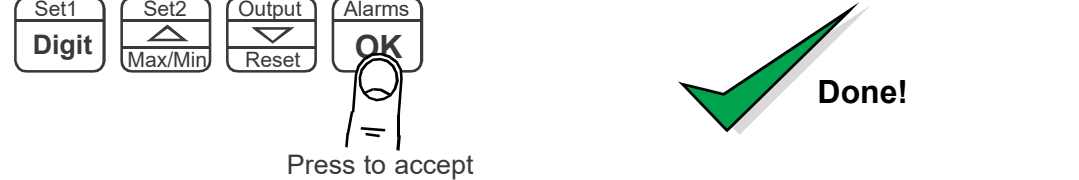

Press to accept

Done!

Calibration Audit Number

Your display includes a non-resettable counter which increments each time you make a change to the display's calibration. This is useful if you want to check whether a display has been altered since it was last calibrated.

The Calibration audit number starts at **CL.01** up to **CL.FF** allowing up to 255 alterations to be recorded. Whenever you want to check the calibration audit number, press and hold the 2 outer buttons (Set1 + Alarms) for more than 3 seconds.

1

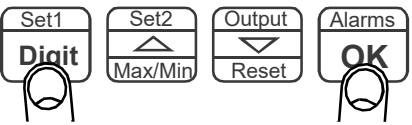

Press together for 3 seconds



Done!

Logic Input Functions

The three contact closure inputs on the rear of the meter have default functions which are:-

- Contact closure 1 = Start (starts timing period, clears display to 0 or preset)
- Contact closure 2 = Stop
- Contact closure 3 = Reset

Note:

You cannot reset or restart the timer if it has not been stopped.
You can tie reset to start to simultaneously reset and start.

1

Set1
Digit

Set2
Max/Min

Output
Start

Alarms
OK

Lockout Switch must be OFF



OFF

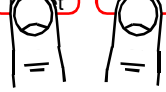

Press 3 seconds



Circuit board ON

2

Set1
Digit

Set2
Max/Min

Output
Reset

Alarms
OK

Press repeatedly until you see **CC. 1**, followed by the existing function for Contact Closure 1.

After you have set **CC. 1**, you will get the prompt **CC. 2** to allow you to set Contact Closure 2 function and when you have set CC.2 you will get the prompt **CC. 3** to allow you to set Contact Closure 3 function

3

Set1
Digit

Set2
Max/Min

Output
Reset

Alarms
OK

Use UP or DOWN buttons to select from these available functions...

Defaults are:-

CC. 1 = START

CC. 2 = STOP

CC. 3 = RST

4

Set1
Digit

Set2
Max/Min

Output
Reset

Alarms
OK



Press to accept



Done!

Logic Input Connections & Front Buttons

The logic input provides a 5V DC signal. When you connect this to common, a current of 1mA will flow.

Because this is a small signal, we recommend you use switches with gold plated contacts, or self cleaning contacts, for best long term reliability.

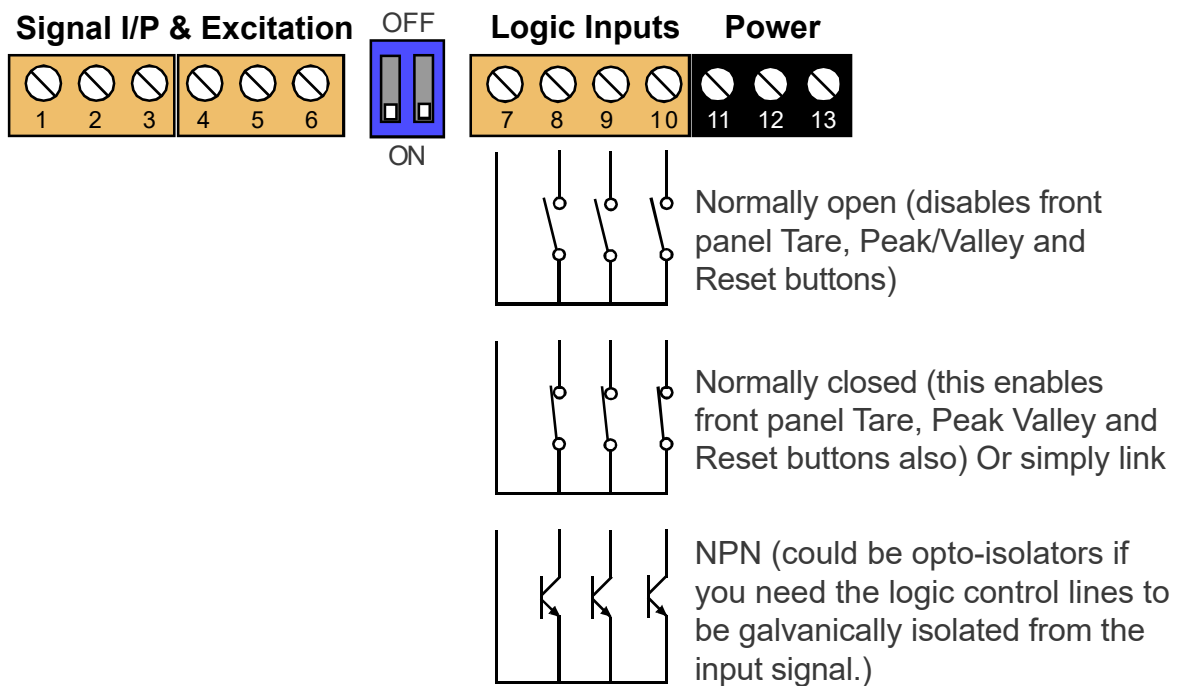

Menu Timeout Adjustment

The display has a default timeout of 60 seconds, to allow you sufficient time to refer to the manual between key operations.

You can make this period shorter, if you wish, once you become more familiar with the setup method.

1

Set1
Digit

Set2
Max/Min

Output
Up/Down

Alarms
OK

Lockout Switch must be OFF



Press together, briefly

Circuit board ON

2

Set1
Digit

Set2
Max/Min

Output
Reset

Alarms
OK

Press repeatedly until you see **DLAY. XX**
where **XX** is the delay in seconds.
Choices are ...

DLAY. 10
DLAY. 20
DLAY. 30
DLAY. 60 (default)

Press repeatedly until you see **DLAY. XX**

3

Set1
Digit

Set2
Max/Min

Output
Reset

Alarms
OK

Press DOWN or UP button briefly and repeatedly to choose from

DLAY. 10 or **DLAY. 20** or **DLAY. 30** or **DLAY. 60**

Press briefly to toggle

4

Set1
Digit

Set2
Max/Min

Output
Reset

Alarms
OK

Done!



Press to accept

Reverse Display Function (Mirror Image)

If you need to be able to see a reflection of the display in a mirror or other reflective surface, for example in a simple heads-up system, or for drivers reversing into a bay, using mirrors only, you can set the display to show as a mirror image.

1

Press together, briefly

Lockout Switch must be OFF

Circuit board ON

2

Press OK button briefly and repeatedly until you see

REV.D 0 (Default) or
REV.D 1

3

Press briefly to toggle

Press DOWN or UP button briefly and repeatedly to choose from
REV.D 0 (normal display) or
REV.D 1 (mirror image display)

4

Press to accept

Done!



Example of normal display format displaying the number 876543



Example of Mirror Reverse display format displaying the number 876543

Bootup Routine & Tare Save Choices

When you switch on your meter, it can be set to power up with 3 possible summary message combinations. The choices are:-

- BOOT 0** = Segment test, followed by a full summary of software revision, calibration audit number, model number, installed options.
- BOOT 1** = Segment test followed by model number (Default)
- BOOT 2** = No summary, meter displays the measurement value immediately power is applied.
- BOOT 3** = All segments illuminate permanently, until a button is pressed.

1

Set1
Digit

Set2
Max/Min

Output
↓

Alarms
OK

Lockout Switch must be OFF

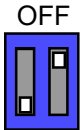

Press together, briefly

Circuit board ON

2

Set1
Digit

Set2
Max/Min

Output
Reset

Alarms
OK

Press OK button briefly and repeatedly until you see **BOOT 0** or **BOOT 1** or **BOOT 2** or **BOOT 3** displayed

3

Set1
Digit

Set2
Max/Min

Output
↑

Alarms
OK

Press DOWN or UP button briefly and repeatedly to choose from **BOOT 0** or **BOOT 1** or **BOOT 2** or **BOOT 3**

Press briefly to toggle

4

Set1
Digit

Set2
Max/Min

Output
Reset

Alarms
OK

Press to accept

5

Set1
Digit

Set2
Max/Min

Output
↑

Alarms
OK

Press briefly to toggle

You can now decide if the tare value is saved on power-down. Select from **TAR .5** to save or **TAR .N** not to save.

6

Set1
Digit

Set2
Max/Min

Output
Reset

Alarms
OK

Press to accept



Done!



You can trigger the full summary message whenever you want, without having to power the meter off, by pressing and holding the 2 outer buttons (Set1 + Alarms) for more than 3 seconds.

Language Selection for User Interface

You can select English or French menu prompts.

1

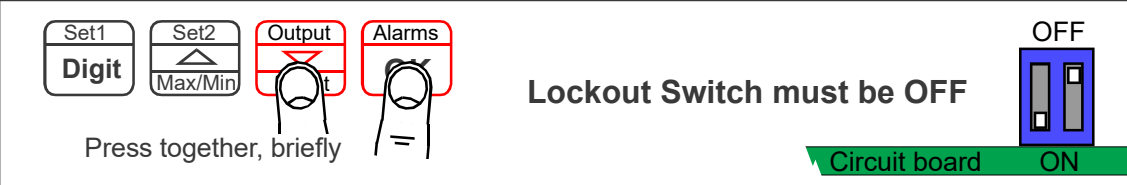

Set1 Digit Set2 Max/Min Output Alarms

Press together, briefly

Lockout Switch must be OFF

Circuit board ON OFF

2

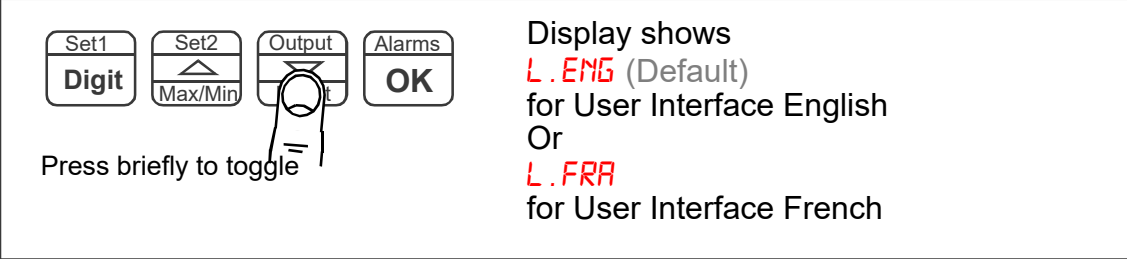

Set1 Digit Set2 Max/Min Output Alarms

Press briefly to toggle

Display shows
L.ENG (Default)
 for User Interface English
 Or
L.FRA
 for User Interface French

3



Set1 Digit Set2 Max/Min Output Reset Alarms

Press to accept

Done!

Error Codes & Fault Findings

1. Time does not automatically correct at summer/winter time changeover.

Check that the **DST** has been set to your region.

How To Install Option Boards



Where the product is intended for "UL" installations removal or addition of option boards is not permitted.



Warning: Disconnect power before you expose the internals of the display

If you want to open your display to install or modify option boards, follow these steps...

- 1) Switch off power to the display and unplug all connectors.
- 2) Undo all the thumb screws on the rear case, store them safely and remove the back panel
- 3) Locate the main option board, which will be similar in appearance to the diagram below. If a main option board is absent, which will be the case if the display was ordered without any output options, then a main option board will need to be fitted.

The board assemblies will look like this...

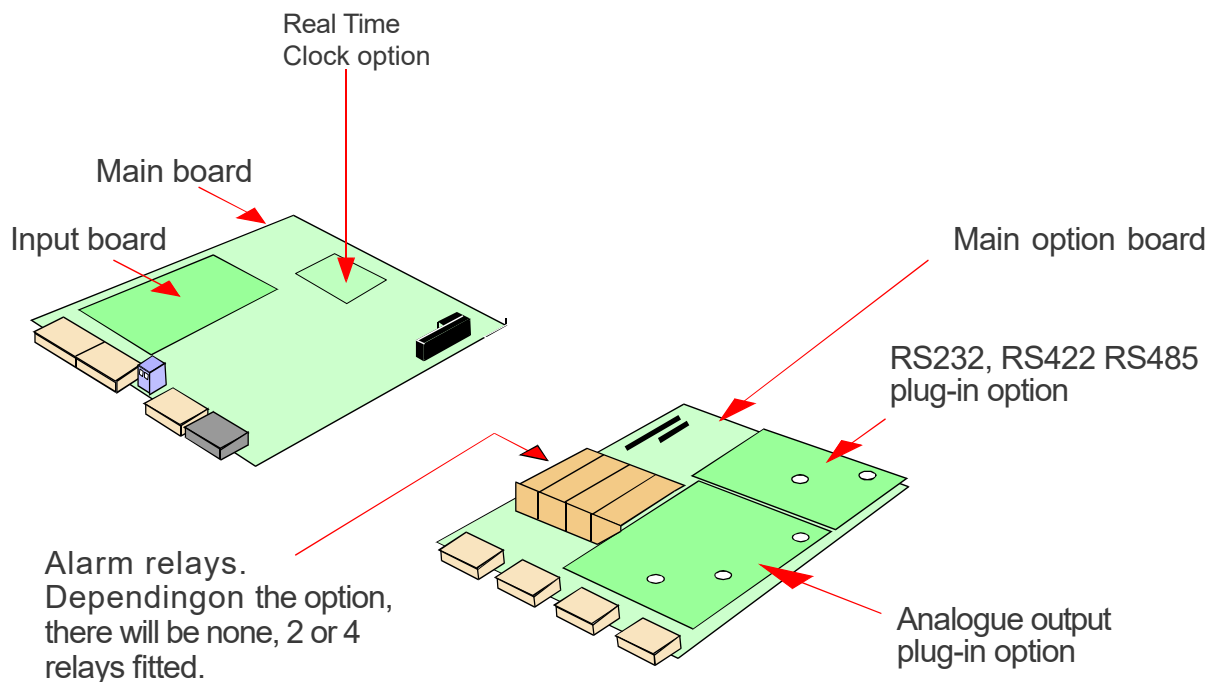

The analogue output and RS232 or RS422 plug-in option boards are fixed to the main option board with white plastic pillars. You must apply a firm force when fitting or removing these options.

Always be careful to connect the pins to sockets accurately. When reassembling, make sure option boards are firmly fixed to the upper option board.

Waste Electrical Electronic Equipment (WEEE)

In Europe, this equipment must be disposed of in accordance with European parliamentary Directive 2002/96/EC

This directive encourages recycling and the reduction of waste materials in the environment.

This means it must be sent to an approved recycling plant if you want to dispose of it.

It must not be thrown away with general rubbish.



WEEE Waste Recycling

If you are unable to dispose of this item locally, you may send it to us for recycling.

Conditions:

1. We will only accept items of our manufacture.
2. You must pay for the transport of the goods to us.
3. We will only accept items if they include a signed declaration by an authorised person in your organisation, stating that :-
 - i. The item is safe to handle and has no contaminants which may be harmful to health.
 - ii. You wish us to dispose of or destroy the item(s)

Equipment Specifications

TECHNICAL DATA									
Digit Height (inches)	2"	4"	6"	8"	12"	16"	24"	32"	48"
Digit Height (mm)	57mm	102mm	150mm	200mm	300mm	400mm	600mm	800mm	1200mm
Viewing Distance (feet)	75ft	150ft	225ft	300ft	450ft	600ft	900ft	1200ft	1800ft
Viewing Distance (metres)	25m	50m	75m	100m	150m	200m	300m	400m	600m
Number of Digits	4 or 6								
Digit Format	8.8.8.8., 8.8.8.8.8.								
Input Signal	Real time clock module (DS3231SN)								
Accuracy	Better than +/- 10 seconds per month								
Battery Backup	CR1620 3V Lithium (retains time in memory during power loss but display is not lit)								
Digit Colour	Blue, green, red, white or yellow								
Brightness	Indoor or outdoor with 7 levels of adjustment								
Power Supply	95-265V AC (standard), 11-30V DC (optional), 48V AC (optional)								
Power Burden	40VA maximum								
Mounting	Brackets supplied for wall, suspension or panel mounting								
Front Panel Controls	Up to 200mm high digits, above 200mm high digits requires an optional wired or wireless controller								
Logic Inputs	3 x NPN or contact closure for START, STOP and RESET when used in timing mode								
Environmental									
Enclosure Material	Heavy duty welded uPVC								
Lens Material	Acrylic								
Sealing	IP65								
Storage Temperature	-20°C to +70°C, non-condensing								
Operating Temperature	0°C to +50°C, non-condensing								
Extended Operating Temperature	-25°C to +50°C, non-condensing (with optional heater fitted inside display)								
Connectors	Internal detachable screw terminal connectors accessed via compression glands								
Analogue Output (optional)									
ANB Option	-10 to +10V into loads >1k Ohms, resolution 0.4mV								
ANI Option	0-20mA or 4-20mA into loads <500 Ohms, resolution 0.4uA								
ANV Option	0-10V into loads >1k Ohms, resolution 0.2mV								
Scaling	Fully adjustable, direct or inverse. Can be derived from GROSS or NETT value								
Response Speed	Derived from displayed value, updated x10 per second, display filtering applies to analogue output								
Linearisation	Derived from displayed value								
Isolation	250V AC optically isolated from input, logic, excitation, power, alarms and data output ports								
Accuracy	+/- 0.1% of range								
Linearity	+/- 0.02% of range								
Stability	+/- 50ppm/°C								
Alarm Outputs (optional)									
AL2 and AL4 Option	2 or 4 x SPST mechanical relays, 2A @ 250V AC, resistive load								
DSS and QSS Option	2 or 4 x solid state relays, specify AC or DC, 100mA max @ 250V AC, 500mA max @ 60V DC								
SPCO Option	2 x SPCO mechanical relays, 2A @ 250V AC, resistive load								
Response Speed	For mechanical relays allow 105mS, for solid state relays allow 100mS								
Data Output (optional)									
232 Option	RS232 ASCII								
485 Option	RS422/RS485 ASCII + Modbus ASCII								
RTU Option	Modbus RTU								
Response Speed	Derived from displayed value, updated x10 per second, display filtering applies to data output								
Isolation	250V AC optically isolated from input, logic, excitation, power, alarms and analogue output ports								

Record of Revisions

6 September 2010	Version F00.18 Software released. Manual format revised to improve clarity and segregate easy from advanced menu functions. Optional outputs now described in their own dedicated manuals. DIN Rail mounting option added. Cabling guidance added.
13 December 2010	Version F00.20 software released (version F00.19 not issued on this model) No performance or feature changes to report in this version.
9 February 2011	Version F00.21 software released.
28 February 2011	Warranty increased to 3 years and terms added.
22 August 2011	Corrected Remote programmer connector details.
31 July 2012	Version F00.22 software released. New timer modes and display formats.
16 July 2019	Start logic input clears elapsed time to 0. Revised software version
6 August 2021	Clarified Start / Stop / Reset sequence in timer mode.
6 August 2022	Clarified button sequencing for setting defaults
20 September 2022	Added UKCA certification
20 June 2024	Backing screws changed to 'M3x8 Socket Flange Button Head Screws'

Notes

Declaration of UK & CE Conformity



Declaration Reference : INTUITIVE Mk4
 Issue Date : 20 September 2022
 Products Covered : INTUITIVE Mk4 series
 Title : DOC-INTUITIVE4

We hereby self-certify that the design and manufacture of this product conforms with the UKCA and CE standards, by complying with the directives and standards below.

Electrical Equipment (Safety) Regulations, 2016 and amendments Low
 Voltage Directive 2014/35/EU
 BS EN 61010-1 : 2010 + A1 : 2019

Electromagnetic Compatibility Regulations, 2016 and amendments
 EMC Directive 2014/30/EU
 EN 61326-1 : 2013
 Immunity for equipment intended to be used in an industrial electromagnetic environment.

Maximum errors of 1% of dynamic range are permitted.
 Instrument must recover automatically from disturbance.

Restriction of the Use of Certain Hazardous Substances in Electrical and Electronic Equipment
 Regulations, 2012 and amendments
 RoHS2 directive incorporating RoHS3 Amendment 2015/863/EU
 EN IEC 63000 : 2018

Conditions

The meters are permitted a worst case error of 1% of A/D range during electro-magnetic disturbance, and must recover automatically when disturbance ceases without the need for human intervention, such as resetting, power-down etc.

The meters covered by this certificate must be installed in adherence to the following conditions :-

Signal cabling shall be routed separately to power carrying cabling (includes relay output wiring)

All signal cabling shall be screened. The screen shall only be terminated to the power earth terminal at the meter end of the cable.

Declared as true and correct, for and on behalf of London Electronics Ltd.

J.R.Lees Director