

**DIGITAL
PANEL METER
N30P TYPE**



USER'S MANUAL



Contents

1. APPLICATION and METER DESIGN	5
2. METER SET	6
3. BASIC REQUIREMENTS, OPERATIONAL SAFETY	7
4. INSTALLATION	8
5. SERVICE	11
6. RS-485 INTERFACE	26
7. ERROR CODES	44
8. TECHNICAL DATA	46
9. ORDER CODES	49
10. MAINTENANCE AND GUARANTEE	51

1. APPLICATION AND METER DESIGN

The N30P meter is a programmable digital panel meter destined for the measurement of a.c. voltage, a.c. current, active, reactive and apparent power, $\cos \varphi$, $\text{tg } \varphi$, φ , frequency, active, reactive and apparent energy, 15 minutes' active power, 10 minutes' voltage, 10 seconds' frequency. Additionally, the meter enables the indication of the current time. The readout field is composed of a display which allows to expose results in red, green and orange colours.

Features of the N30P meter:

- display colour individually in three ranges,
- thresholds of displayed overflows,
- 2 NOC relay alarms operating in 6 modes,
- 2 switched relay alarms operating in 6 modes (option),
- signaling of measuring range overflow,
- automatic setting of the decimal point,
- programming of voltage and current ratios,
- programming of alarm and analog outputs with the reaction on any measured value, independently of the currently displayed value,
- storage of maximal and minimal values of all input quantities,
- reset of all watt-hour meters: active and reactive energy,
- programmed kind of 15 minutes' active power measurement: mean walking or synchronization with the RTC clock,
- manual synchronization of 15 minutes' power, 10 minutes' voltage,
- monitoring of set parameter values,
- interlocking of parameter introduction by means of a password,
- service of the interface with MODBUS protocol in the RTU mode (option),
- conversion of the measured value into a standard – programmable current or voltage signal (option),

- highlighting of any measuring unit acc. to the order,
- galvanic separation between terminals: alarm, supply, input, analog, pulse output, RS-485 interface.

The switching of the alarm output on, is signaled by the highlighting of the output number.

The casing protection grade from the frontal side is IP 65.

Meter overall dimensions: 96 × 48 × 93 mm (with terminals).

The meter casing is made of plastics.



Fig. 1 View of the N30P digital meter

2. METER SET

The set is composed of:

- N30P meter 1 pc
- User's manual 1 pc
- Guarantee card 1 pc
- Clamps to fix in the panel 4 pcs
- Seal 1 pc

When unpacking the meter, please check whether the type and execution code on the data plate correspond to the order.

3. BASIC REQUIREMENTS, OPERATIONAL SAFETY

In the safety service scope, the meter meets the requirements of the EN 61010-1 standard.



Observations concerning the operational safety

- All operations concerning transport, installation, and commissioning as well as maintenance, must be carried out by qualified, skilled personnel, and national regulations for the prevention of accidents must be observed.
- The programming of N30P meter parameters must be carried out after disconnecting measuring circuits
- Before switching the meter on, one must check the correctness of connections to the network.
- Do not connect the meter to the network through an autotransformer.
- Before removing the meter housing, one must switch the supply off and disconnect measuring circuits.
- The removal of the meter housing during the guarantee contract period may cause its cancellation.
- The meter fulfills requirements related to electromagnetic compatibility in the industrial environment
- When connecting the supply, one must remember that a switch or a circuit-breaker should be installed in the building. This switch should be located near the device, easy accessible by the operator, and suitably marked as an element switching the meter off.
- Non-authorized removal of the housing, inappropriate use, incorrect installation or operation, creates the risk of injury to personnel or meter damage. For more detailed information, please study the User's Manual.

4. INSTALLATION

The meter has separable strips with screw terminals which enable the connection of external wires of 2.5 mm^2 cross-section. In execution for current measurement, the plug enables a permanent fixing to the socket by means of screws.

The meter is adapted to be mounted in a panel by means of clamps, acc. to the fig. 2. One must prepare a hole of $92^{+0.6} \times 45^{+0.6} \text{ mm}$ in the panel which the thickness should not exceed 6 mm.

The meter must be introduced from the panel front with disconnected supply voltage. Before the insertion into the panel, one must check the correct placement of the seal. After the insertion into the hole, fix the meter by means of clamps (fig.2).

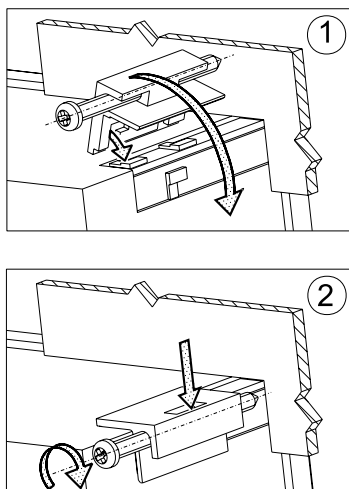

Fig. 2. Meter fixing

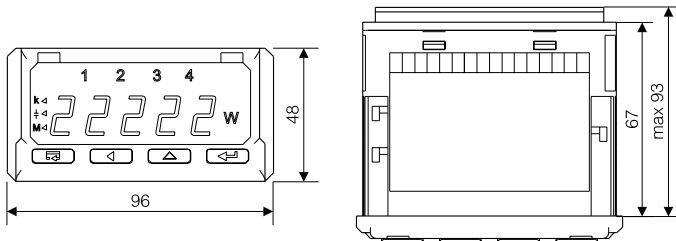

Fig. 3. Overall dimensions

4.1. Connection Diagrams

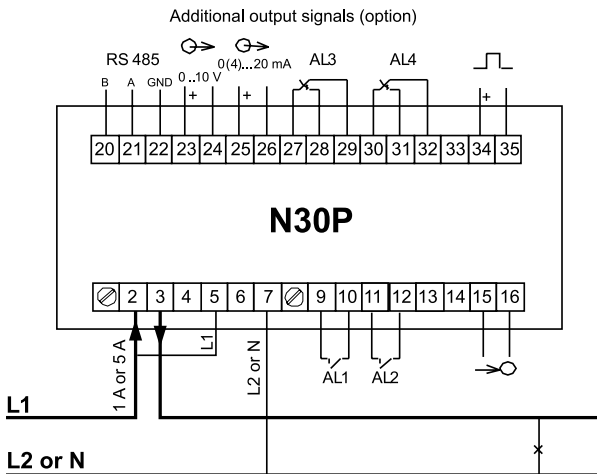

Fig. 4. Electrical connections of the N30P meter for direct measurements

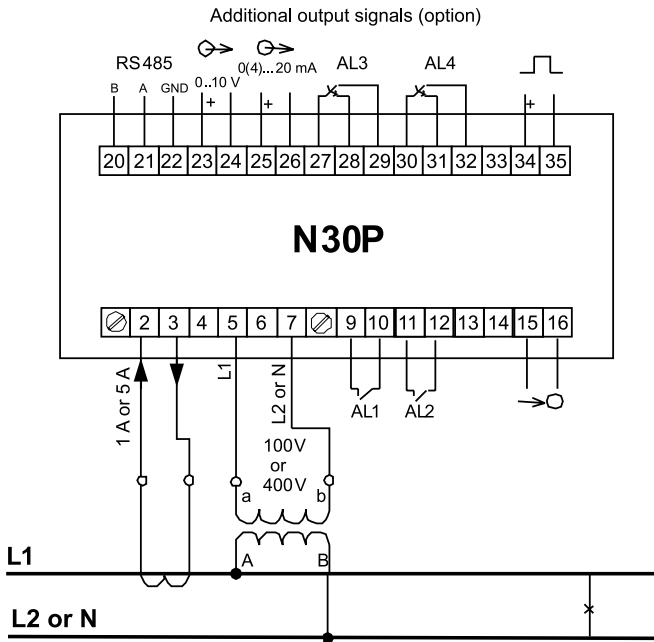

Fig. 5. Electrical connections of the N30P meter for indirect measurements

5. SERVICE

5.1. Display Description

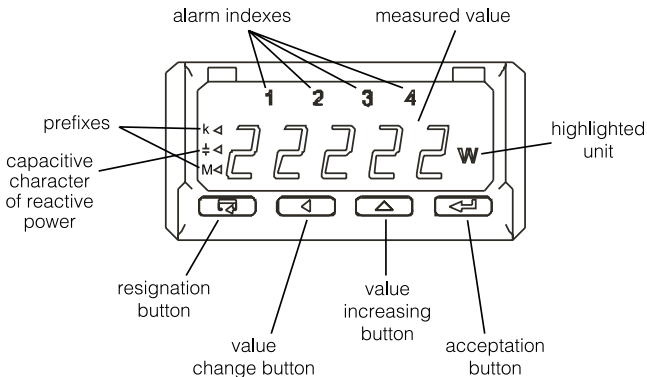

Fig. 6. Description of the meter frontal plate

5.2. Messages after switching the supply on

After switching the switching supply on, the meter displays the meter name N30P and next the program version in the shape „r x.xx” – where x.xx is the number of the current program version or the number of a custom-made execution. Next the meter carries out measurements and displays the value of the input signal. The meter sets automatically the decimal point position when displaying the value, using prefixes k – kilo, M – mega. The overflow of alarm thresholds is signaled by highlighting alarm indexes 1, 2, 3, 4 and switching relays (for alarm 3 and 4 – relays are as option). The meter highlights automatically the unit of the measured value. In case of an error occurrence or any exceeding of the range value, a message described in the chapter 7 will be displayed on the display.

5.3. Functions of buttons



- Acceptation button:

- ⇒ entry in programming mode (hold down ca 3 seconds) (przytrzymanie przez około 3 sekund),
- ⇒ moving through the menu – choice of level,
- ⇒ moving through the menu monitoring the measured values,
- ⇒ entry in the mode changing the parameter value,
- ⇒ acceptance of the changed parameter value.



- Button increasing the value:

- ⇒ display of maximal value,
- ⇒ display of maximal value – menu monitoring the measured parameters,
- ⇒ entry in the level of the parameter group,
- ⇒ moving through the chosen level,
- ⇒ change of the chosen parameter value – increasing the value.



- Button to change the digit:



- ⇒ display of minimal value,
- ⇒ display of minimal value – menu monitoring the measured parameters,
- ⇒ entry in the level of parameter group,
- ⇒ moving through the chosen level,
- ⇒ change of chosen parameter value – shift on the next digit,
- ⇒ next parameter in the monitoring mode of meter parameters.







- resignation button:

- ⇒ entry in the menu monitoring the meter parameters (holding down ca 3 seconds),





- ⇒ exit from the menu monitoring meter parameters and measured values,
- ⇒ resignation of the parameter change,
- ⇒ absolute exit from the programming mode.





The pressure of the button combination   and holding down them ca 3 seconds causes the reset of alarm signaling. This operation acts only when the support function is switched on.



The pressure of the button combination   causes the erasing of all minimal values.

The pressure of the button combination   causes the erasing of all maximal values.

The pressure and holding down the  button ca 3 seconds causes the entry to the programming matrix. The programming matrix is protected by the safety code.

The pressure and holding down the  button 3 seconds causes the entry to the menu monitoring meter parameters. One must move through the monitoring menu by means of  and  buttons. In this menu all programmable meter parameters are only accessible for readout, excepting service parameters. The exit for the monitoring menu is carried out by means of the  button. In the monitoring menu, parameter symbols are displayed alternately with their values. The service algorithm of the meter is presented on the fig. 7.

The pressure and holding down  and  buttons, ca 3 seconds, causes the entry to the menu monitoring measured values. One must move through the monitoring menu by means of ,  and  buttons.

The pressure of the  button causes the display of successive symbol of measured value alternately with the value. The pressure of the  button causes the display of minimal value of the currently

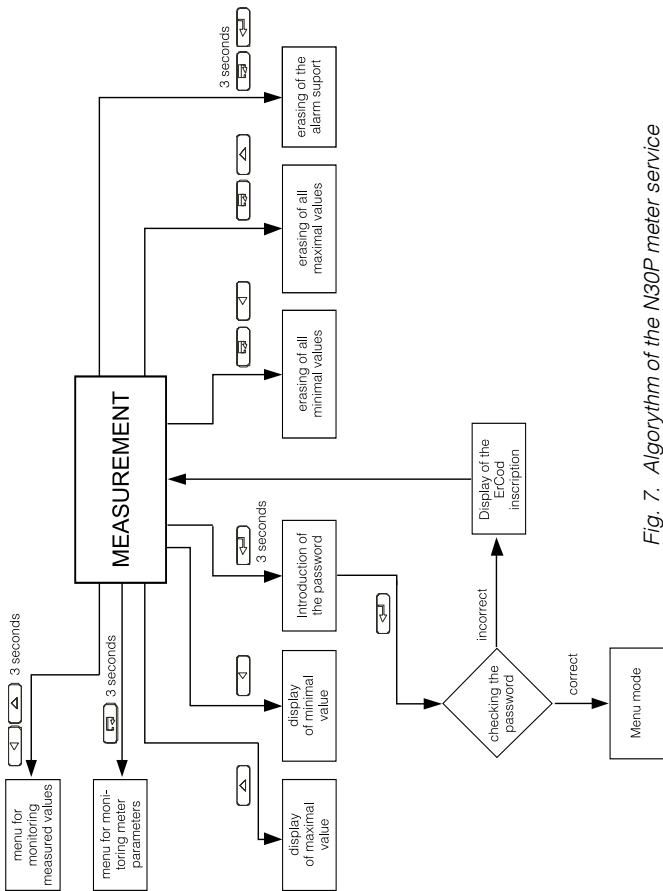













Fig. 7. Algorithm of the N30P meter service

displayed value, however the pressure of the  button causes the display of the maximal value of the currently displayed value.

The exit from the monitoring menu is carried out by means of the  button.



5.4. Programming

The pressure of the  button and holding it down through ca 3 seconds causes the entry to the programming matrix. If the entry is protected by a password, then the safety code symbol **SEC** is displayed alternately with the set value **0**. The write of the correct code causes the display of the **ErCod** inscription. The matrix of transitions to the programming mode is presented on the fig. 8. The choice of the level is made by means of the  button, however the entry and moving through the parameters of the chosen level is carried out by means of the  and  buttons,

Parameter symbols are displayed alternately with their current values. In order to change values, one must use the  button. To resign fo the parameter change, one must press the  button. In order to exit from the chosen level, one must chose the ---- symbol and press the  buton or press the button . To exit from the programming matrix, one must press several times the  button till the appearance of the inscription **End** and after ca 3 seconds, the meter enters automatically in the measurement of the input quantity.

Value Change Way of the Chosen Parameter

Change of Integral Values



In order to increase the value of the chosen parameter, one must press the  buton. The single pressure of the button, causes the increase of the value of 1. The holding down of the  button

Pos. no	InPUt	tYP	SYn	rAnU	rAnI	trU	trI	PAvs	-----	
1	Input parameters	Type displayed quantity	Type of input synchronization	Voltage input range	Current input range	Voltage ratio	Current ratio	Synchron. of 15 minutes' power	-----	
2	dISp Display parameters	dP Minimal decimal point	CoLdo Lower colour	CoLbe Middle colour	CoLUP Upper colour	CoLLo Lower threshold of colour change	CoLHI Upper threshold of colour change	ovrLo Lower overflow	ovrHi Upper overflow	
3	ALr1 Alarm 1	P_A1 Type of input quantity for alarm 1	PrL_1 Lower threshold	PrH_1 Upper threshold	tYP_1 Alarm type	dLY_1 Alarm delay	LEd_1 Signal support.	-----	-----	
4	ALr2 Alarm 2	P_A2 Type of input quantity for alarm 2	PrL_2 Lower threshold	PrH_2 Upper threshold	tYP_2 Alarm type	dLY_2 Alarm delay	LEd_2 Signal support.	-----	-----	
5	ALr3 Alarm 3	P_A3 Type of input quantity for alarm 3	PrL_3 Lower threshold	PrH_3 Upper threshold	tYP_3 Alarm type	dLY_3 Alarm delay	LEd_3 Signal support.	-----	-----	
6	ALr4 Alarm 4	P_A4 Type of input quantity for alarm 4	PrL_4 Lower threshold	PrH_4 Upper threshold	tYP_4 Alarm type	dLY_4 Alarm delay	LEd_4 Signal support.	-----	-----	
7	oUt* Output	P_An Type of input for analog output	An_Lo Lower threshold for analog output	An_HI Upper threshold for analog output	tYP_A Kind of output (volt/curr.)	bAUd Baud rate	Prot Kind of transmission	Addr Device address	-----	
8	SEr Service	SEt Write of standard parameters	SEC Password introduction	HoUr Time setting	Unit Highlight the unit	C_EnP Reset active energy watt-hour meter	C_Enq Reset reactive energy watt-hour meter	C_PAV Begin the synchronization of 15 minutes' power	C_UAV Begin the synchronization of 10 minutes' voltage	tEST Display test

* Do not occur in the execution without additional output plate.



Fig. 8. Transition matrix in the programming mode

causes a continuous increase of the value on the given digit. The increase of value when displaying the digit 9 causes the setting of 0 on this digit. The change of the digit follows after pressing the  button.

In order to accept the set parameter, one must hold down the  button. Then, the saving of the parameter follows and the display of its symbol alternately with the new value. The pressure of the  button during the change of the parameter value will cause the resignation of the write.

Changing of Values

The change is carried out in three stages (the transition to the next stage follows after pressing the  button):

- 1) setting the value from the range -19999M...99999M, similarly as for integral values;
- 2) setting of the decimal point position (00000., 0000.0, 000.00, 00.000, 0.0000); the  button shifts the decimal point to the left, however the  button shifts the decimal point to the right;
- 3) choice of the prefix: lack, k, M; the  button switches the next prefix; the chosen prefix is displayed in orange.





The pressure of the  button during the change of the parameter value will cause the resignation of the saving.

Table 1



Parameter symbol	Description	Range of changes
tYP	Choice of the displayed quantity	U – RMS voltage I – RMS current P – active power q – reactive power S – apparent power PF – factor of active power tG – ratio of reactive power to the active power FI – phase shift FrEq - frequency EPPoS – active energy input EPneg – active energy output EqPoS – reactive energy input Eqneg – reactive energy output PAv – 15 minutes' mean active power UAv – 10 minutes' mean voltage FAv – 10 seconds' mean frequency HoUr – current time
SYn	Type of input synchronization	U – synchronization with voltage (measurement of all values) I – synchronization with current (only measurement of current and frequency)
rAnU	Choice of voltage range	100U – range 100 V 400U – range 400 V
rAnI	Choice of current range	1A – range 1 A 5A – range 5 A
trU	Choice of voltage ratio	1...4000.0
trl	Choice of current ratio	1...10000
PAv S	Synchronization of 15 minutes' power	CntS – walking window qUArt – measurement every quarter of an hour synchronized with the clock

dp	Minimal position of the decimal point when displaying the measured value.	0.0000 – 0 00.0000 – 1 000.00 – 2 0000.0 – 3 00000 – 4 k 000.00 – 5 k 0000.0 – 6 k 00000 – 7 M 000.00 – 8 M 0000.0 – 9 M 00000 – 10
CoLdo	Display colour when the displayed value is less than CoLLo	rEd – red GrEEen – green orAnG – yellow
CoLbE	Display colour when the displayed value is higher than CoLLo and less than CoLHI	
CoLUP	Display colour when the displayed value is higher than CoLHI	
CoLLo	Lower threshold of display colour change	-19999M ... 99999M
CoLHI	Upper threshold of display colour change	-19999M ... 99999M
ovrLo	Lower threshold of the display constraint 	-19999M ... 99999M
ovrHI	Upper threshold of the display constraint 	-19999M ... 99999M

P_A1 P_A2 P_A3 P_A4	Kind of input value type, which the alarm has to react on.	U – RMS voltage I – RMS current P – active power q – reactive power S – apparent power PF – active power factor tG – ratio of reactive power to active power FI – phase shift FrEq - frequency EPPoS – active energy input EPnEG – active energy output EqPoS – reactive energy input EqnEG – reactive energy output PAv – 15 minutes' mean active power UAv – 10 minutes' mean voltage FAv – 10 seconds' mean frequency.
PrL 1 PrL 2 PrL 3 PrL 4	Lower alarm threshold.	-19999M ... 99999M
PrH 1 PrH 2 PrH 3 PrH 4	Upper alarm threshold.	-19999M ... 99999M
tYP 1 tYP 2 tYP 3 tYP 4	Alarm type. The fig. 9. presents a graphic display of alarm types.	n-on – normal (transition from 0 to 1), n-off – normal (transition from 1 to 0), on - switched on, off – switched off, H-on – manually switched on; till the time of alarm type change, the alarm output remains switched on for good. H-off – Manually switched off; till the time of alarm type change, the alarm output remains switched off for good.
dLY_1 dLY_2 dLY_3 dLY_4	Delay of alarm switching.	0...120 seconds

LEd_1 LEd_2 LEd_3 LEd_4	<p>Supporting of alarm signaling. In the situation when the support function is switched on after the alarm state retreat, the signaling diode is not put out. It signals the alarm state till the moment of its extinction by means of the  button combination. </p> <p>The function concerns only and exclusively the alarm signaling, that is the relay contacts will operate without support in compliance with the chosen alarm type.</p>	on – support switched on off – support switched off
P_An	<p>Kind of input value type, which the analog output has to react on.</p>	U – RMS voltage I – RMS current P – active power q – reactive power S – apparent power PF – active power factor tG – ratio of reactive power to active power FI – phase shift FrEq – frequency EPPoS – active energy input EPnEG – active energy output EqPoS – reactive energy input EqnEG – reactive energy output PAv – 15 minutes' mean active power UAv – 10 minutes' mean voltage FAv – 10 seconds' mean frequency.
An_Lo	<p>Lower threshold of the analog output. One must give the value for which we want to obtain 0 on the analog output.</p>	-19999M ... 99999M
An_Hi	<p>Upper threshold of the analog output. One must give the value for which we want to obtain the maximal signal on the analog output (20 mA or 10V).</p>	-19999M ... 99999M
tYPA	<p>Type of the analog output</p>	0_10U – voltage 0...10 V 0_20A – current 0...20 mA 4_20A – current 4...20 mA

bAUd	Baud rate of the RS-485 interface transmission.	4800 – 4800 bit/s 9600 – 9600 bit/s 19200 – 19200 bit/s 38400 – 38400 bit/s
Prot	Kind of transmission through the RS-485 interface.	r8n2 – RTU 8N2 r8E1 – RTU 8E1 r8o1 – RTU 8O1 r8n1 – RTU 8N1
Addr	Device address	1...247
SEt	Write of manufacturer settings. Parameter values set by the manufacturer are presented in the table 2.	The setting of the value YES causes the saving of standard parameters in the meter.
SEC	Introduction of a new password.	0...60000
HoUr	Setting of the current time.	0,00...23,59 The introduction of an erroneous time causes at the acceptance, the setting 23, however the introduction of erroneous minutes will cause the setting of the value 59.
UnIt	Selection of measured value for which the unit is highlighted.	U – RMS voltage I – RMS current P – active power q – reactive power S – apparent power PF – active power factor tG – ratio of reactive power to active power FI – phase shift FrEq - frequency EPPoS – active energy input EPnEG – active energy output EqPoS – reactive energy input EqnEG – reactive energy output PAv – 15 minutes' mean active power UAv – 10 minutes' mean voltage FAv – 10 seconds' mean frequency.
C_EnP	Reset of active watt-hour meters	The choice YES causes the reset of active watt-hour meters

C_Enq	Reset of reactive watt-hour meters	The choice YES causes the reset of reactive watt-hour meters.
C_PAv	Synchronization of 15 minutes' mean active power	The choice YES causes the beginning of 15 minutes' mean active power measurement.
C_UAv	Synchronization of 10 minutes' mean voltage	The choice YES causes the beginning of 10 minutes' mean voltage measurement.
tEst	Display test. The test consist on the successive lighting up of digital display segments. Alarm diodes and highlighting diodes should be lighted.	The choice YES causes the switching of the test on. The pressure of the  button ends the test.
-----	Exit from the parameter group of the chosen level.	The pressure of the  button causes the exit from the parameter group of the chosen level.

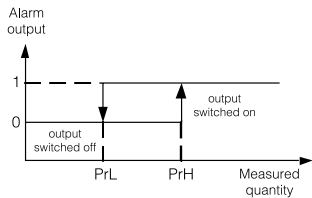

a) n-on

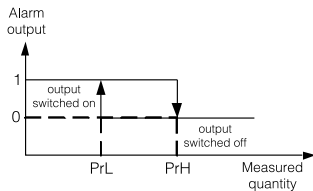

b) n-off

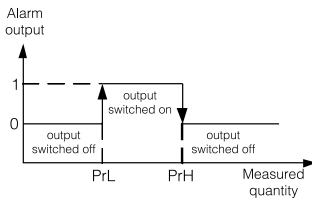

c) on

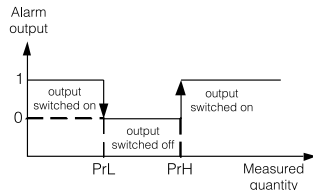

d) off

Fig. 9. Alarm types: a) n-on, b) n-off c) on d) off.

Remaining types of alarms: h-on – always switched on;
h-off – always switched off.

Caution!



- In case of alarms of **n-on**, **n-oFF**, **on**, **oFF** types the write of **PrL>PrH** will cause the alarm switching off.
- In case of a measuring range overflow, the reaction of the n-th relay is compatible with written **PrL_n**, **PrH_n**, **tYP_n** parameters. In spite of the displayed overflow, the meter still carries out the measurement.
- The meter controls currently the value of the introduced parameter at the moment. In case when the introduced value overflows the upper range given in the table 1, the meter will make automatically the change into the maximal value. Similarly, in case when the introduced value overflows the lower change range given in the table 1, the meter will make automatically the change into the minimal value.

5.5. Manufacturer's Parameters

Table 2

Parameter symbol	Level in the matrix	Standard value
tYP	1	P
SYn	1	U
rAnU	1	400 U
rAnI	1	5 A
trU	1	1,0
trl	1	1
PAv S	1	CntS
dP	2	0.0000 (0)
CoLdo	2	GrEEEn
CoLbE	2	orAnG
CoLUP	2	rEd
CoLLo	2	920
CoLHI	2	1150
ovrLo	2	99999M

ovrHI	2	-19999M
P_A 1	3	P
PrL_1	3	920
PrH_1	3	1150
tYP_1,	3	n-on
P_A 2	4	I
PrL_2	4	4.000
PrH_2	4	5.000
tYP_2,	4	n-on
P_A3	5	U
PrL_3	5	200.00
PrH_3	5	250.00
tYP_3,	5	oFF
P_A 4	6	PF
PrL_4	6	0.800
PrH_4	6	0.999
tYP_4	6	oFF
dLY_1, dLY_2, dLY_3, dLY_4	3,4,5,6	0
LEd_1, LEd_2, LEd_3, LEd_4	3,4,5,6	off
P_An	7	I
tYP_A	7	0...20 mA
An_Lo	7	0.000
An_HI	7	5.000
bAUd	7	9600
Prot	7	r8n2
Addr	7	1
SEC	8	0
HoUr	8	0.00
Unit	8	P

6. INTERFACE RS-485

N30P programmable digital meters have serial links in RS-485 standards for the communication in computer systems and with other devices fulfilling Master function. An asynchronous communication character protocol MODBUS has been implemented on the serial link. The transmission protocol describes ways of information interchange between devices through the serial link.

6.1. Connection Way of the Serial Interface

The RS-485 standard allows to a direct communication of 32 devices on a single serial link of 1200 m long. For the connection of a higher quantity of devices, it is necessary to apply additional intermediate-separating systems.

The leading of the interface line out is given in the meter user's manual. To obtain a correct transmission, it is necessary to connect lines A and B with their equivalent in other devices. The connection must be made through a shielded wire. The shield must be connected to the protection terminal in a single point. The GND line serves to the additional protection of the interface line at long connections. One must connect it to the pro-

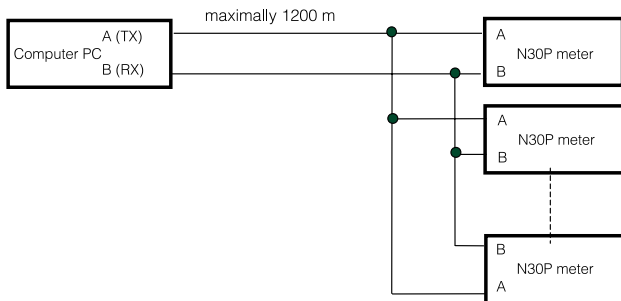

Fig. 10. Connection way of the RS-485 interface

tection terminal (it is not necessary for a correct interface work).

To obtain the connection with a computer of IBM PC class, a RS-485 card or a RS-232/RS-485 converter is indispensable.

The connection way of devices is shown on the fig. 10

The designation of transmission lines for the card in the PC komputer depends on the card producer.

6.2. Description of the MODBUS Protocol Implementation.

The implemented protocol is in accordance with the PI-MBUS-300 Rev G of Modicon Company specification.

Set of the serial link parameters of meters in MODBUS protocol:

- meter address 1...247,
- baud rate 4800, 9600, 19200, 38400 bit/s,
- work modes RTU,
- information unit RTU: 8N2, 8E1, 8O1, 8N1,
- maximal response time 1000 ms.

Parameter configuration of the serial link is described in the further part of the user's manual. It consists on the settlement of the baud rate (**bA**ud parametr), device address (**Addr** parameter), and the type of the configuration unit (**Mode** parameter)

Notice:

Each meter connected to the communication network must have :

- unique address, different from addresses of other devices connected to the network,
- identical baud rate and type of information unit.

Following functions of the MODBUS protocol hale been implemented in the N30P meter:

Table 3

Code	Meaning
03	Readout of n-registers
16	Write of n-registers
17	Identification of the slave device.

6.3. Register Map of the N30P Meter

Table 4

Range of addresses	Value type	Description
4000-4100	integer (16 bitów)	Value placed in a 16-bit register.
7000-7199	float (32 bity)	Value placed in two successive 16-bit registers. Registers include the same data as 32-bit register from the area 7500. Registers are only for readout.
7200-7400	float (32 bity)	Value placed in two successive 16-bit registers. Registers include the same data as 32-bit register from the area 7600. Registers can be read out and written.
7500-7599	float (32 bity)	Value placed in a 32-bit register. Registers are only for readout.
7600-7700	float (32 bity)	Value placed in a 32-bit register. Registers can be read out and written.

6.4. Registers for Write and Readout

Table 5

Values placed In 16-bit registers	Symbol	Write (w)/Readout (r)	Range	Description	
4000	tYP	w/r	0...16	Input type	
				Value	
				0	RMS voltage
				1	RMS current
				2	Active power
				3	Reactive power
				4	Apparent power
				5	Active power factor
				6	Ratio of reactive/active power
				7	Phase shift
				8	Frequency
				9	Input of active energy
				10	Output of active energy
				11	Input of reactive energy
				12	Output of reactive energy
				13	15 minutes' mean active power
				14	10 minutes' mean voltage
				15	10 secondes' mean frequency
16	Current time				
4001	SYn	w/r	0...1	Synchronization of input	
				Value	
				0	Synchronization with the voltage (measurement of all values)
				1	Synchronization with the current (only current and frequency)

4002	rAn U	w/r	0...1	Voltage input range	
				Value	
				0	Range 100 V
				1	Range 400 V
4003	rAn I	w/r	0...1	Current input range	
				Value	
				0	Range 1 A
				1	Range 5 A
4004	tr u	w/r	1...40000	Voltage ratio *0.1	
4005	tr I	w/r	1...10000	Current ratio	
4006	PAv S	w/r	0...1	15 minutes' power synchronization	
				Value	
				0	Measurement every quarter synchronized with the clock
				1	Walking window
4007	Reserved				
4008	Reserved				
4009	dP	w/r	0...10	Minimal decimal point	
				Value	
				0	0.0000
				1	00.000
				2	000.00
				3	0000.0
				4	00000
				5	k 000.00
				6	k 0000.0
				7	k 00000
				8	M 000.00
				9	M 0000.0
10	M 00000				
4010	CoLdo	w/r	0...2	Display colour when the displayed value is less than in the register 7600	
				Value	
				0	red
				1	green
				2	orange

4011	CoLbE	w/r	0...2	Display colour when the displayed value is higher than in the register 7600 and less than in register 7601.
				Value
				0
				red
				1
				green
				2
				orange
4012	CoLuP	w/r	0...2	Display colour when the displayed value is higher than in the register 7601
				Value
				0
				red
				1
				green
				2
				orange
4013	P_A1	w/r	0...15	Kind of the input quantity type on which the alarm 1 has to react.
				Value
				0
				RMS voltage
				1
				RMS current
				2
				Active power
				3
				Reactive power
				4
				Apparent power
				5
				Active power factor
				6
				Ratio of reactive/active power
				7
				Phase shift
				8
				Frequency
				9
				Input of active energy
				10
				Output of active energy
				11
				Input of reactive energy
				12
				Output of reactive energy
				13
				15 minutes' mean active power
				14
				10 minutes' mean voltage
				15
				10 secondes' mean frequency

4014	tYP_1	w/r	0...5	Type of alarm 1 (description – fig. 6)	
				Value	
				0	n-on
				1	n-oFF
				2	on
				3	oFF
				4	H-on
				5	H-oFF
4015	dLY_1	w/r	0...120	Delay of alarm 1 (in seconds)	
4016	LEd_1	w/r	0...1	Support of alarm 1 signaling	
				Value	
				0	Support switched off
				1	Support switched on
4017	P_A2	w/r	0...15	Kind of the input quantity type on which the alarm 2 has to react.	
				Value	
				0	RMS voltage
				1	RMS current
				2	Active power
				3	Reactive power
				4	Apparent power
				5	Active power factor
				6	Ratio of reactive/active power
				7	Phase shift
				8	Frequency
				9	Input of active energy
				10	Output of active energy
				11	Input of reactive energy
				12	Output of reactive energy
				13	15 minutes' mean active power
				14	10 minutes' mean voltage
15	10 seconds' mean frequency				

4018	tYP_2	w/r	0...5	Type of alarm 2 (description – fig. 6)	
				Value	
				0	n-on
				1	n-oFF
				2	on
				3	oFF
				4	H-on
5	H-oFF				
4019	dLY_2	w/r	0...120	Delay of alarm 2 (in seconds)	
4020	LEd_2	w/r	0...1	Support of alarm 2 signaling	
				Value	
				0	Support switched off
				1	Support switched on
4021	P_A3	w/r	0...15	Kind of the input quantity type on which the alarm 3 has to react.	
				Value	
				0	RMS voltage
				1	RMS current
				2	Active power
				3	Reactive power
				4	Apparent power
				5	Active power factor
				6	Ratio of reactive/active power
				7	Phase shift
				8	Frequency
				9	Input of active energy
				10	Output of active energy
				11	Input of reactive energy
				12	Output of reactive energy
				13	15 minutes' mean active power
14	10 minutes' mean voltage				
15	10 seconds' mean frequency				

4022	tYP_3	w/r	0...5	Type of alarmu 3 (description – fig. 6)	
				Value	
				0	n-on
				1	n-oFF
				2	on
				3	oFF
				4	H-on
				5	H-oFF
4023	dLY_3	w/r	0...120	Delay of alarm 3 (in seconds)	
4024	LEd_3	w/r	0...1	Support of alarm 3 signaling	
				Value	
				0	Support switched off
				1	Support switched on
4025	P_A4	w/r	0...15	Kind of the input quantity type on which the alarm 4 has to react.	
				Value	
				0	RMS voltage
				1	RMS current
				2	Active power
				3	Reactive power
				4	Apparent power
				5	Active power factor
				6	Ratio of reactive/active power
				7	Phase shift
				8	Frequency
				9	Input of active energy
				10	Output of active energy
				11	Input of reactive energy
				12	Output of reactive energy
				13	15 minutes' mean active power
				14	10 minutes' mean voltage
15	10 seconds' mean frequency				

4026	tYP_4	w/r	0...5	Type of alarm 4 (description – fig. 6)	
				Value	
				0	n-on
				1	n-oFF
				2	on
				3	oFF
				4	H-on
4027	dLY_4	w/r	0...120	Delay of alarm 4 (in seconds)	
4028	LEd_4	w/r	0...1	Support of alarm 4 signaling	
				Value	
				0	Support switched off
				1	Support switched on
4029	P_An	w/r	0...15	Kind of the input quantity type on which the analog output has to react.	
				Value	
				0	RMS voltage
				1	RMS current
				2	Active power
				3	Reactive power
				4	Apparent power
				5	Active power factor
				6	Ratio of reactive/active power
				7	Phase shift
				8	Frequency
				9	Input of active energy
				10	Output of active energy
				11	Input of reactive energy
				12	Output of reactive energy
				13	15 minutes' mean active power
14	10 minutes' mean voltage				
15	10 seconds' mean frequency				

4030	tYP_A	w/r	0...2	Type of analog output	
				Value	
				0	Voltage 0...10 V
				1	Current 0...20 mA
				2	Current 4...20 mA
4031	bAUd	w/r	0...3	Baud rate	
				Value	
				0	4800 bit/s
				1	9600 bit/s
				2	19200 bit/s
				3	38400 bit/s
4032	Prot	w/r	0...3	Baud rate	
				Value	
				0	RTU 8N2
				1	RTU 8E1
				2	RTU 8O1
				3	RTU 8N1
4033	Addr	w/r	0...247	Device address	
4034	sAvE	w/r	0...1	Update display parameters	
				Value	
				0	without changes
				1	update
4035	SEt	w/r	0...1	Write of standard parameters	
				Value	
				0	without changes
				1	set standard parameters
4036	SEC	w/r	0...60000	Password for parameters	
				Value	
				0	without password
				...	entry in parameters preceded by a request about the password
4037	HoUr	w/r	0...2359	Current time	
				<p>This parameter occurs in the ggmm format, where: gg - means hours, mm – means minutek.</p> <p>The introduction o a wrong hour will cause the setting 23, however the introduction of wrong minutes will generate the setting 59.</p>	

4038	Unit	w/r	0...16	Switch on and off the unit display	
				Value	
				0	RMS voltage
				1	RMS current
				2	Active power
				3	Reactive power
				4	Apparent power
				5	Active power factor
				6	Ratio of reactive/active power
				7	Phase shift
				8	Frequency
				9	active energy
				10	reactive energy
				11	apparent energy
				12	Output of reactive energy
				13	15 minutes' mean active power
				14	10 minutes' mean voltage
				15	10 secondes' mean frequency
				16	Current time
17	Switched off for good.				
				The unit is displayed when the value In the register 4000 is equal to the value In the register 4038	
4039	C_EnP	w/r	0...1	Reset of active watt-hour meters	
				Value	
				0	Lack of operation
				1	Reset of active watt-hour meters
4040	C_Enq	w/r	0...1	Reset of reactive watt-hour meters	
				Value	
				0	Lack of operation
				1	Reset of reactive watt-hour meters
4041	C_PAv	w/r	0...1	Synchronization of 15 minutes' mean power	
				Value	
				0	Lack of operation
				1	Beginning of the 15 minutes' mean power synchronization

Bit-15 Damage of the non-volatile memory

- 0 – memory operating correctly
- 1 – signaling of damaged memory

Bit-14 Non-calibrated meter

- 0 – measuring inputs of the meter are calibrated
- 1 – signaling of lack of meter input calibration

Bit-13 Value error of meter parameters

- 0 – meter parameters are correct
- 1 – readout signaling of wrong meter parameters

Bit-12 Error of energy values

- 0 – correct energies
- 1 – readout signaling of incorrect meter energy values.

Bit-11, bit 10 Analog output

Bit 11	Bit 10	Meaning
0	0	voltage output 0...10 V
0	1	current output 0...20 mA
1	0	current output 4...20 mA
1	1	lack of calibration of analog output

Bit-9 Uśrednianie częstotliwości 10 sekundowej

- 0 – a full interval of frequency averaging time is going by
- 1 – a full interval of frequency averaging time is not going by

Bit-8 Averaging of 10 minutes' voltage

- 0 – a full interval of voltage averaging time is going by
- 1 – a full interval of voltage averaging time is not going by

Bit-7 Averaging of 15 minutes' active power

- 0 – a full interval of power averaging time is going by
- 1 – a full interval of power averaging time is not going by

Bit-4 Signaling of too small values of voltage and/or current

- 0 – normal work
- 1 – too small voltage, current to measure the power factor $\text{tg}(\text{fi})$, fi

Bit-3 State relay (alarm) 4

0 – switched off

1 – switched on

Bit-2 State relay (alarm) 3

0 – switched off

1 – switched on

Bit-1 State relay (alarm) 2

0 – switched off

1 – switched on

Bit-0 State relay (alarm) 1

0 – switched off

1 – switched on

Table 6

The value placed in two successive 16-bit registers. These registers include the same data as 32-bit registers from the area 7600	The value is placed in 32-bit registers	Symbol	write (w)/readout (r)	Range	Description
7200	7600	CoLLO	w/r	-19999M...99999M	Lower threshold of the display colour change
7202	7601	CoLHI	w/r	-19999M...99999M	Upper threshold of the display colour change
7204	7602	ovrLo	w/r	-19999M...99999M	Lower threshold of the display narrowing
7206	7603	ovrHI	w/r	-19999M...99999M	Upper threshold of the display narrowing

7208	7604	PrL_1	w/r	-19999M...99999M	Lower threshold of alarm 1 (Aoff)
7210	7605	PrH_1	w/r	-19999M...99999M	Upper threshold of alarm 1 (Aon)
7212	7606	PrL_2	w/r	-19999M...99999M	Lower threshold of alarm 2 (Aoff)
7214	7607	PrH_2	w/r	-19999M...99999M	Upper threshold of alarm 2 (Aon)
7216	7608	PrL_3	w/r	-19999M...99999M	Lower threshold of alarm 3 (Aoff)
7218	7609	PrH_3	w/r	-19999M...99999M	Upper threshold of alarm 3 (Aon)
7220	7610	PrL_4	w/r	-19999M...99999M	Lower threshold of alarm 4 (Aoff)
7222	7611	PrH_4	w/r	-19999M...99999M	Upper threshold of alarm 4 (Aon)
7224	7612	An_Lo	w/r	-19999M...99999M	Lower threshold of analog output
7226	7613	An_HI	w/r	-19999M...99999M	Upper threshold of analog output

6.5. Registers only for Readout

Table 7

The value placed in two successive 16-bit registers. These registers include the same data as 32-bit registers from the area 7500	The value is placed in 32-bit registers	Name	write (w)/readout (r)	Unit	Name of the quantity
7000	7500	Identifier	r	-	Constant identifying the device 179 (0xB3) - N30P
7002	7501	Status	r	-	Status is register describing the current state of the meter (the same value as in register 4044)
7004	7502	Control	r	%	It is a register defining the control of the analog output
7006	7503	Minimum	r	-	Minimal value of the currently displayed value

7008	7504	Maksimum	r	–	Maximal value of the currently displayed value
7010	7505	Displayed Value	r	–	Currently displayed value
7012	7506	Reserved			
7014	7507	Reserved			
7016	7508	Reserved			
7018	7509	U	r	V	RMS voltage
7020	7510	I	r	A	RMS current
7022	7511	P	r	W	Active power
7024	7512	Q	r	var	Reactive power
7026	7513	S	r	VA	Apparent power
7028	7514	PF	r		Active power factor
7030	7515	tG	r		Ratio of reactive/active power
7032	7516	Fl	r	°	Phase shift
7034	7517	FrEq	r	Hz	Frequency
7036	7518	Reserved			
7038	7519	Reserved			
7040	7520	Reserved			
7042	7521	PAv	r	W	15 minutes' mean power
7044	7522	UAv	r	V	10 minutes' mean voltage
7046	7523	FAv	r	Hz	10 seconds' mean frequency
7048	7524	HoUr	r	gg,mm	Current time
7050	7525	U_min	r	V	Minimal value of RMS voltage
7052	7526	U_max	r	V	Maximal value of RMS voltage
7054	7527	I_min	r	A	Minimal value of RMS current
7056	7528	I_max	r	A	Maximal value of RMS current
7058	7529	P_min	r	W	Minimal value of active power
7060	7530	P_max	r	W	Maximal value of active power
7062	7531	Q_min	r	var	Minimal value of reactive power
7064	7532	Q_max	r	var	Maximal value of reactive power

7066	7533	S_min	r	VA	Minimal value of apparent power
7068	7534	S_max	r	VA	Maximal value of apparent power
7070	7535	PF_min	r		Minimal value of active power factor
7072	7536	PF_max	r		Maximal value of active power factor
7074	7537	tG_min	r		Minimal value of reactive/active power ratio
7076	7538	tG_max	r		Maximal value of reactive/active power ratio
7078	7539	FI_min	r	°	Minimal value of phase shift
7080	7540	FI_max	r	°	Maximal value of phase shift
7082	7541	FrEq_min	r	Hz	Minimal value of frequency
7084	7542	FrEq_max	r	Hz	Maximal value of frequency
7086	7543	PAv_min	r	W	Minimal value of 15 minutes' mean active power
7088	7544	PAv_max	r	W	Maximal value of 15 minutes' mean active power
7090	7545	UAv_min	r	V	Minimal value of 10 minutes' mean voltage
7092	7546	UAv_max	r	V	Maximal value of 10 minutes' mean voltage
7094	7547	FAv_min	r	Hz	Minimal value of 10 seconds' mean frequency
7096	7548	FAv_max	r	Hz	Maximal value of 10 seconds' mean frequency
7098	7549	EP_PoS1	r	100MWh	Active energy input (the counter of turning the register 7550 is reset every 9999999.9 kWh)
7100	7550	EP_PoS2	r	kWh	Active energy input (modulo 100000.0)
7102	7551	EP_nEG1	r	100MWh	Active energy output (the counter of turning the register 7552 is reset every 9999999.9 kWh)
7104	7552	EP_nEG2	r	kWh	Active energy output (modulo 100000.0)

7106	7553	Eq_PoS1	o	100Mvarh	Reactive energy input (the counter of turning the register 7554 is reset every 9999999.9 kVarh)
7108	7554	Eq_PoS2	o	kvarh	Reactive energy input (modulo 100000.0)
7110	7555	Eq_nEG1	o	100Mvarh	Reactive energy output (turning counter of the register 7556 is reset every 9999999.9 kVarh)
7112	7556	Eq_nEG2	o	kvarh	Reactive energy output (modulo 100000.0)

7. ERROR CODES

After switching the meter to the network, messages about errors can appear. Reasons about errors are presented below.

The appearance of below mentioned symbols on digital displays means:



Overflow of upper value of programmed indication range.



Overflow of lower value of programmed indication range.

ErCAL

Loss of meter calibration values. One must contact the service workshop.

ErOUT

Loss of calibration values of meter analog outputs. The pressure of the ESC button switches the message off, analog outputs remain switched off. One must contact the service shop.

Er EE

Innapropriate values in meter configuring data. The pressure of the ESC button switched the message off. One must set meter parameters again.

ErEnr Incorrect energy values in the meter. The pressure of the ESC button switched the message off. Energies are reset.

ErCod Password incorrectly introduced.

During the meter operation, messages about errors can appear. Reasons of errors are presented below:

1) **Eravr** - when the voltage and/or current is too small or too high during the measurement:

- P_{fi} , $tg\varphi_i$, φ below 10% U_n , I_n

- f below 10% U_n

2) **ErPAv** - the full interval of the power P_{Av} averaging time is not going by.

3) **ErUAv** - the full interval of the voltage U_{Av} averaging time is not going by.

4) **ErFAv** - the full interval of the frequency F_{Av} averaging time is not going by.

8. TECHNICAL DATA

Measuring Ranges

Table 8

Measured value	Indication range	Measuring range	Basic error
Current 1/5 A	0.000...60 kA	0.02...6 A~	±0.2%
Voltage 100/400 V	0.0...1.92 MV	1...480 V~	±0.2%
Frequency	45.00...100.00 Hz	45.0...66.0...100 Hz	±0.2%
Active power	-19999... 99999 MW	-2.88 kW...1.40 W...2.88 kW	±0.5%
Reactive power	-19999 Mvar...0.00 ...99999 Mvar	-2.88 kvar...1.40 var...2.88 kvar	±0.5%
Apparent power	0.00...99999 MVA	1.40 VA... 2.88 kVA	±0.5%
Coefficient PF	-1...0...1	-1...0...1	±0.5%
Tangens φ_i	-1.2...0...1.2	-1.2...0...1.2	±1%
φ	0...359	0...359	±1%
Active energy	0...9 999 999.9 kWh	0...9 999 999.9 kWh	±0.5%
Reactive energy	0...9 999 999.9 kvarh	0...9 999 999.9 kvarh	±0.5%
Current time	0.00...23.59	0.00...23.59	1 second /24 h

Ku – voltage transformer ratio: 0.1...4000.0

Ki – current transformer ratio: 1...10000

Relay outputs

- relays, voltageless NOC contacts
load-carrying capacity 250 V/0.5 A
- relays, voltageless switched contacts
load-carrying capacity 250 V/0.5 A
(option)

Analog output (option)

- current programmable 0/4...20 mA
load resistance $\leq 500 \Omega$
- voltage programmable 0...10 V
load resistance $\geq 500 \Omega$
- galvanically isolated
- resolution 0.01% of the range

Serial interfaces (option)

RS485: address 1...247
Mode: 8N2, 8E1, 8O1,8N1
Baud rate: 4.8, 9.6, 19.2, 38.4 kbit/s
Transmission protocol: Modbus RTU
Maximal time to begin a response:
1000 ms

Energy pulse output (option)

output of O/C type, passive of
A class acc.to EN 62053-31,
supply voltage 18...27 V,
current 10...27 mA

**Pulse constant
of O/C type output**

5000 imp./kWh, independently of
Ku, Ki settings

Galvanic separation between:

- supply - measuring input	3.2 kV d.c.
- supply - analog output	2 kV d.c.
- supply - pulse output	2 kV d.c.
- supply - RS485 interface	2 kV d.c.
- measuring input - analog output	3.2 kV d.c.
- measuring input - pulse output	3.2 kV d.c.
- measuring input - RS485 interface	3.2 kV d.c.
- analog input - pulse output	2 kV d.c.
- analog input - RS485 interface	2 kV d.c.
- alarm output - other circuits	2 kV d.c.

Protection grade ensured by the casing:

- from frontal side	IP 65
- from rear side	IP 10

Weight 0.2 kg

Dimensions 96 x 48 x 93 mm

Reference Conditions and Rated**Operating Conditions:**

- supply voltage	85...253 V d.c or a.c 40...400 Hz 20...40 V d.c or a.c 40...400 Hz
------------------	---

- input signal	0... <u>0.005</u> ... <u>1.2</u> I_n ; <u>0.05</u> ... <u>1.2</u> U_n for current, voltage 0... <u>0.1</u> ... <u>1.2</u> I_n ; 0... <u>0.1</u> ... <u>1.2</u> U_n ; for coefficients P_{fi} , $t\phi_i$, φ frequency <u>45</u> ... <u>66</u> ...100 Hz; sinusoidal (THD \leq 8%)
- power factor	<u>-1</u> ... <u>0</u> ... <u>1</u>
- ambient temperature	- <u>25</u> ... <u>23</u> ...+ <u>55</u> $^{\circ}\text{C}$
- storage temperature	- <u>30</u> ...+ <u>70</u> $^{\circ}\text{C}$
- relative air humidity	25...95% (inadmissible condensation)
- admissible peak factor of:	
- current	2
- voltage	2
- external magnetic field	<u>0</u> ... <u>400</u> A/m
- short duration overload (5 s):	
- voltage inputs	2 U_n (max. 1000 V)
- current inputs	10 I_n
- work position	any
- input power	6 VA

Additional Errors in % of the basic error:

- from frequency of input signals	< 50%
- from ambient temperature changes	< 50%/10 $^{\circ}\text{C}$

Standards Fulfilled by the Meter:

Electromagnetic Compatibility:

- noise immunity acc.to EN 61000-6-2
- noise emissions acc. to EN 61000-6-4

Safety Requirements: acc. to EN 61010-1 standard

- isolation between circuits: basic,
- installation category III,
- pollution level 2,
- maximal earth-to-phase voltage 600 V
- altitude above sea level < 2000 m,

Preheating Time 15 minutes

9. ORDER CODES

Table 9

DIGITAL PANEL METER	N30P -	X	X	XX	XX	X	X
Supply:							
85... 253 V a.c./d.c.		1					
20... 40 V a.c./d.c.		2					
Additional outputs:							
lack		0					
pulse output, RS485, analog outputs		1					
pulse output, RS485, analog outputs, switched-over relay outputs		2					
Unit:							
unit code number acc. to the tab. 10				XX			
Version:							
standard						00	
custom-made*						XX	
Language:							
Polish							P
English							E
other*							X
Acceptance tests:							
without extra quality requirements							0
with an extra quality inspection certificate							1
acc. to customer's request*							X

* - after agreeing with the manufacturer.

Order example:

The code: **N30P - 1 0 01 00 E 0** means:

N30P – programmable N30P panel digital meter

1 – supply: 85...253 V a.c.,

0 – lack of additional outputs,

01 – unit "V" acc. to the table 10,

00 – standard version,

E – English language,

0 – without extra quality requirements,

Code	Unit	Code	Unit
00	lack of unit	29	%
01	V	30	%RH
02	A	31	pH
03	mV	32	kg
04	kV	33	bar
05	mA	34	m
06	kA	35	l
07	W	36	s
08	kW	37	h
09	MW	38	m ³
10	var	39	turns
11	kvar	40	pcs
12	Mvar	41	imp
13	VA	42	rsp
14	kVA	43	m/s
15	MVA	44	l/s
16	kWh	45	turn/min
17	MWh	46	rpm
18	kvarh	47	mm/min
19	Mvarh	48	m/min
20	kVAh	49	l/min
21	MVAh	50	m ³ /min
22	Hz	51	pcs/h
23	kHz	52	m/h
24	Ω	53	km/h
25	kΩ	54	m ³ /h
26	°C	55	kg/h
27	°F	56	l/h
28	K	XX	on order ¹⁾

1) - After agreeing with the manufacturer

10. MAINTENANCE AND GUARANTEE

The N30P digital panel meter does not require any periodical maintenance.

In case of some incorrect operations:

1. From the Shipping Date, During the Period Given in the Annexed Guarantee Card

One should take the meter down from the installation and return it to the Manufacturer's Quality Control Dept.

If the meter has been used in compliance with the instructions, the Manufacturer warrants to repair it free of charge.

2. After the Guarantee Period:

One should turn over the meter to repair it in a certified service workshop.

The disassembling of the casing causes the cancellation of the granted guarantee.

Our policy is one of continuous improvement and we reserve the right to make changes in design and specifications of any products as engineering advances or necessity requires and revise the above specifications without notice.

N30P-07

