

# London Electronics Limited

Warren Court, Chicksands, Shefford, Bedfordshire SG17 5QB  
Tel +44(0)1462-850967 Fax +44(0)1462-850968  
www.london-electronics.com help@london-electronics.com

---

**Panel mounting counter / ratemeter**

## **INT-C and INT-F**

**Connection details, scaling and general information**

---

Digital Scaling and calibration  
User friendly, time-saving design  
Fast installation and commissioning

**This manual covers software version C-F 2.1**

# Alphabetic Index

Alarm board Configuration	23
Alarms, how to set	24
Analogue Output configuration	25
Analogue output, how to set	26
Chronometer mode	16
Connections	5 & 6
Declaration of Conformity	31
Error messages	21
Failsafe alarm setting	23
General description	3
Getting Started	4
Hysteresis adjustment	24
Installing options	22
Introduction	1
Input connection examples	6
Modes of operation	7
Operating Modes	7
Peak / Valley detection and memory	20
Period / Bake time	18
Quadrature totaliser	15
Rate settings	8
Rate scaling examples	9
Reset command	20
Revisions record	29
Run Time mode	17
Serial Communications	27
Specifications	28
Totaliser- simple single input	10
Totaliser - Gated	11
Totaliser - UP/DOWN with direction flag	12
Totaliser - Dual input UP/DOWN	13
Totaliser - Dual Input UP/UP	14
Totaliser - Quadrature	15
Warnings	2

# Introduction

Please contact us if you need help, if you have a complaint, or if you have suggestions to help us improve our products or services for you.

If you contact us about a product you already have, please tell us the full model number and serial number, so that we can give you accurate and fast help.

This product has a 2 year warranty. We will put right or replace any meter which is faulty because of bad workmanship or materials. This warranty does not cover damage caused by misuse or accident.

## ***IMPORTANT***

If this equipment is important to your process, you may want to buy a spare to cover possible failure or accidental damage in the future.

This is because at some times, for example during our factory shutdown periods, you may have to wait several weeks for an equivalent replacement. Or, we may have no stock at the time you urgently need it.

You may also need to pay extra carriage charges if you want a fast, guaranteed courier service. Warranty repairs or replacements are normally returned with a standard courier service.

We do not offer any compensation for losses caused by failure of this instrument.

If you do not agree with these conditions, please return this item now, in unused, clean condition, in its original packaging and we will refund the purchase price, excluding any carriage paid.

We thought you'd prefer to know about possible delays and extra charges now, rather than during a panic.

We always try to improve our products and services, so these may change over time. You should keep this manual safely, because future manuals, for new designs, may not describe this product accurately.

We believe these instructions are accurate, and that we have competently designed and manufactured the product, but please let us know if you find any errors.

# Warnings



**Please carefully read all warnings and ONLY install the meter when you are sure that you've covered all aspects.**

- \* Connect the meter according to current IEE regulations and separate all wiring according to IEC1010.
- \* Power supplies to this equipment must have anti-surge (T) fuses at 125mA for 230V supply, 250mA for 110V supply or 1A for DC supplies in the range 11-30VDC.
- \* Check that the model number and supply voltage suit your application before you install the meter.
- \* Don't touch any circuitry after you have connected the meter, because there may be lethal voltages on the circuit board.
- \* We designed this meter for Installation class II service only. This means it has exposed electrical and power terminals, so you must install it in an enclosure to protect users from electric shock.
- \* We designed this meter for Pollution-Degree 2 environments only. This means you must install it in a clean, dry environment, unless it has extra protection from a splashproof cover, such as our SPC4
- \* Only adjust on-board switches or connections with the power turned off
- \* Make sure all screw terminals are tight before you switch the meter on.
- \* Only clean the meter with a soft damp cloth. Only lightly dampen with water. Do not use any other solvents.

***Safety First .....Don't assume anything..... Always double check. If in doubt, ask someone who is QUALIFIED to assist you in the subject.***

# General Description

You can set this meter as a scalable frequency/rate meter or as a scalable totaliser. In rate mode, the meter needs only one cycle to compute frequency, so is faster than most gated frequency meters. It accepts many different sensor types, such as NPN, PNP and contact closure proximity sensors and differential output proximity sensors, as well as simple contact closures. It provides a 24V excitation supply to power active sensors.

We designed the meter to be simple to configure. It is easy to use because no menu is used. Look at the front panel below... to change MODE you press the MODE button, to adjust Analogue Output you press the OUTPUT button, to adjust Alarms you press the ALARM button. There is no need to spend time learning a complex menu system.

Peak and valley memories allow you to view the minimum and maximum recorded speed / frequency measurements. The meter can give alarm outputs, scaled and isolated analogue output and isolated serial data retransmission when fitted with suitable option boards.

The front panel has a 6 digit, 7 segment window to display the measurement. It can include decimal point and minus sign characters and has 4 alarm annunciators to show the status of each alarm relay.

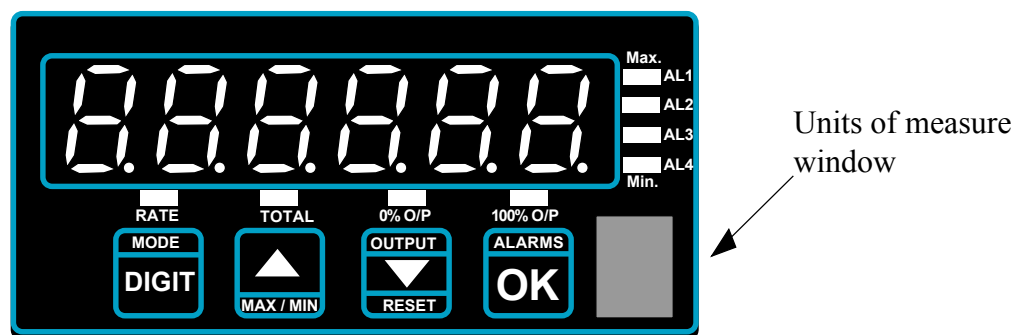

To change variables when the meter is unlocked, select digits using the DIGIT key, and increase or decrease with UP and DOWN key. When the setting is correct, press OK.

A lockout switch on the rear of the meter protects your configuration settings, which are saved in memory. This has a 10 year guaranteed storage period. If the lockout switch is not set ON, your settings could be accidentally altered.

# Getting Started

First, please check that the display will suit your application. Page 2 has some important warnings - please check that all warnings are covered.

If you have analogue output or alarm relay options, you may need to configure their boards before installing the meter in a panel. See the separate sections in this manual for those options.

Check that your panel cutout is correct , 92mm wide, 45mm high. You must fit the meter in a protective enclosure for installation class II service. Remove the 2 screws holding the U clamp at the rear of the case. Slide the meter into the cutout and re-fit the U clamp and screws. Tighten the screws just enough to hold the meter firmly in place and make sure the sealing gasket is evenly held between the panel and the bezel.

Connect the signal and power cables, to the appropriate screw terminal connectors. Check that you are using the correct terminals or you may cause damage to the meter. Do not connect any output or alarm cabling yet.

Apply power, and check that all segments light for a few seconds and then show the software version “C-F X.X” briefly (The X numerals depend on version).

The lockout switch should be OFF to allow you to change the meter’s settings. Set the scaling to suit your system, using one of the scaling methods described in this manual. Check that the meter responds correctly. Now, adjust your analogue output settings, if necessary, and alarm settings. Use a DVM of sufficient precision to check that the analogue output is operating as required, and use a continuity tester to check that the relay contacts operate correctly. Switch the meter off, and check alarm relay contact status. Check that the contact status suits your system, in conditions of power loss to the meter.

When you have checked all settings, you can connect the alarm relay and analogue output cables, if these options are installed, to check that your system operates correctly.

Remember to set the lockout switch ON when you have finished , to protect your settings.

# Connections

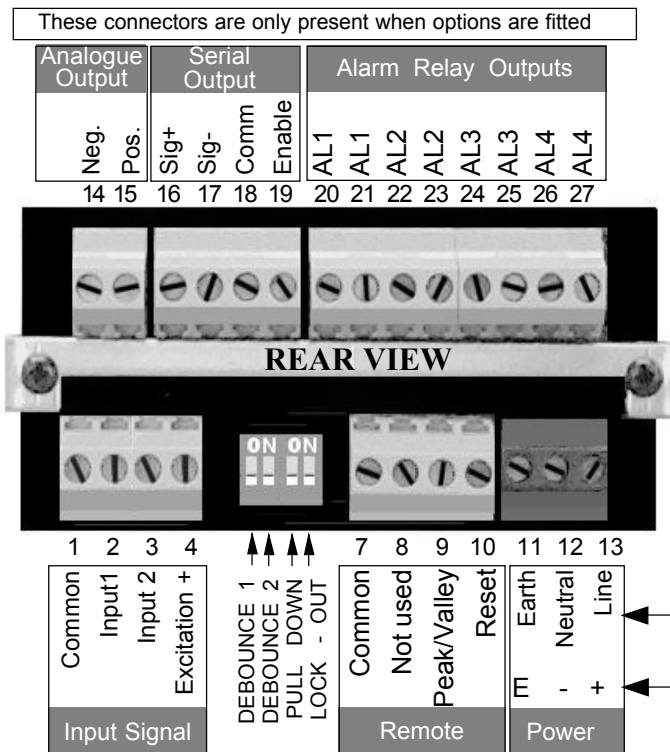

## Serial Output Connection Notes

### 1) RS232 option type

The RS232 data appears on terminal 16  
 Data common on terminal 18  
 RTS on terminal 19  
 Pullup on terminal 17

To produce a continuous stream of data, connect terminals 17 and 19 together, or, for one-shot transmissions, apply a single pulse of 5V level to terminal 19.

### Mains Power model

### DC Power model

### 2) RS422 option type

The RS422 data appears on terminals 16 and 17. Common is on terminal 18.

To produce a continuous stream of data, connect terminals 18 and 19 together, or, for one-shot transmissions, apply a single pulse of 0V level to terminal 19

The ON position is marked on the switch and may differ with different manufacturers.

The LOCKOUT switch *must* be set ON when settings are complete

## How to install input signal cabling :-

This meter responds to pulse signals. It is important that only wanted pulses are applied to the meter, not noise pulses, or your readings will have errors. Some rules are...

- 1) Always use screened cable for the input signal.
- 2) Connect the screen at one end only, preferable at the meter end.
- 3) Do not place input cable near power cable or alarm relay cabling.

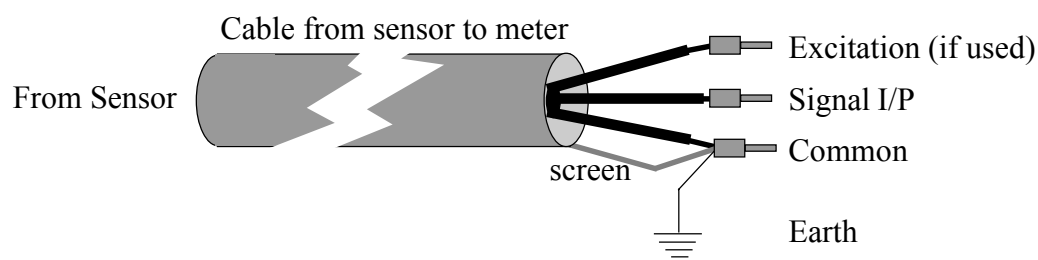

# INPUT Connection & Selection Examples

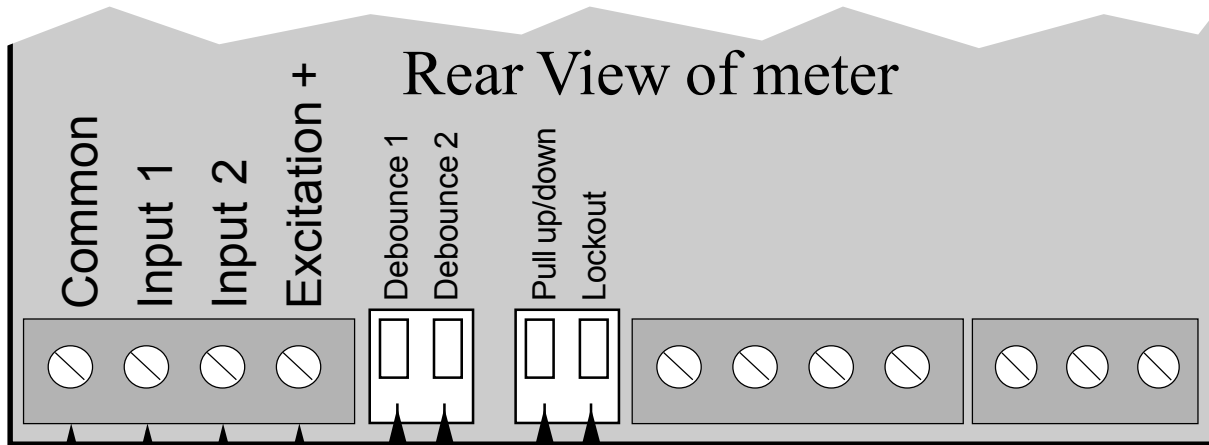

<input checked="" type="checkbox"/>	<input checked="" type="checkbox"/>	<input checked="" type="checkbox"/>	<input type="checkbox"/>	<b>ON</b>	<b>ON</b>	<b>OFF</b>	<b>Lock</b>	Contact closure	<b>A</b>
<input checked="" type="checkbox"/>	<input checked="" type="checkbox"/>	<input checked="" type="checkbox"/>	<input checked="" type="checkbox"/>	<b>OFF</b>	<b>OFF</b>	<b>OFF</b>	<b>Lock</b>	3 wire NPN	<b>A</b>
<input checked="" type="checkbox"/>	<input checked="" type="checkbox"/>	<input checked="" type="checkbox"/>	<input checked="" type="checkbox"/>	<b>OFF</b>	<b>OFF</b>	<b>ON</b>	<b>Lock</b>	3 wire PNP	<b>A</b>
<input checked="" type="checkbox"/>	<input checked="" type="checkbox"/>	<input checked="" type="checkbox"/>	<input checked="" type="checkbox"/>	<b>OFF</b>	<b>OFF</b>	<b>ON</b>	<b>Lock</b>	Quadrature encoder	<b>A</b>
<input checked="" type="checkbox"/>	<input checked="" type="checkbox"/>	<input checked="" type="checkbox"/>	<input type="checkbox"/>	<b>OFF</b>	<b>OFF</b>	<b>ON</b>	<b>Lock</b>	CMOS 5-18V	<b>A</b>
<input checked="" type="checkbox"/>	<input checked="" type="checkbox"/>	<input type="checkbox"/>	<input type="checkbox"/>	<b>OFF</b>	<b>OFF</b>	<b>ON</b>	<b>Lock</b>	AC Tacho	<b>A/B</b>
<input checked="" type="checkbox"/>	<input checked="" type="checkbox"/>	<input type="checkbox"/>	<input type="checkbox"/>	<b>OFF</b>	<b>OFF</b>	<b>ON</b>	<b>Lock</b>	Passive magnetic pickup	<b>B/C</b> *

✓ = Connect to this terminal if you have a second sensor and want to totalise pulses from 2 sources

\*  
If you switch debounce 1 = ON, with passive magnetic pickup, the frequency response is modified as follows:-

10Hz	=35mV RMS
30Hz	=60mV RMS
100Hz	=140mV RMS
300Hz	=350mV RMS
1KHz	=2.5V RMS
3KHz	=3.5V RMS
10KHz	=10V RMS

**Sensitivity jumpers inside meter**  
Channel 2 cannot be set for sensitivity ranges B or C. It is permanently set at sensitivity range A

**A** Factory default  
2.5V / 3.5V threshold

**B** Medium sensitivity  
0v / +1V threshold (Ch1)

**C** High Sensitivity  
0v / +20mV threshold (Ch1)

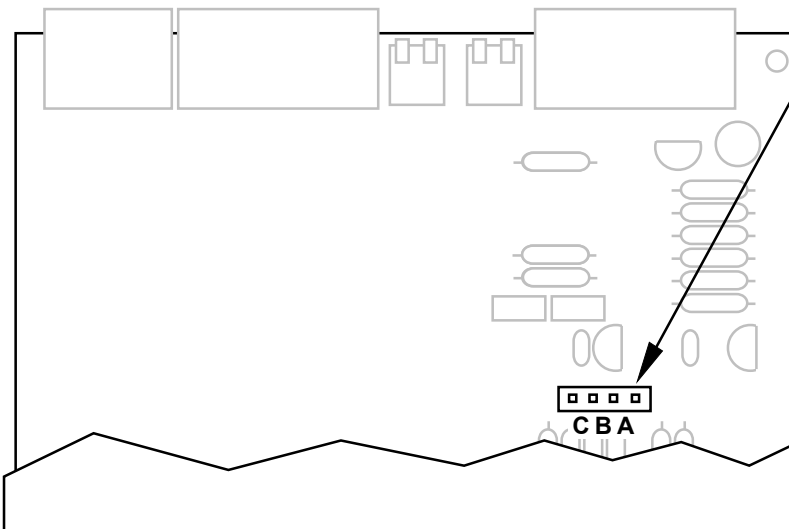

# Operating Modes

You can configure your meter either as a scalable ratemeter or as one of several scalable totaliser or quadrature counter modes.

- a. Set lockout switch OFF.
- b. Press the MODE key, and the display will show the meter's present mode
- c. Press the UP or DOWN keys to select desired mode, from the list below.
- d. Press OK to select a mode. Then, your scaling settings will be requested. Press DIGIT to select digits to alter, UP or DOWN key to increase and decrease, and OK to accept. The following pages describe the settings for each mode.
- e. When you have finished, set the lockout switch ON, to prevent accidental alteration.

The modes you can select are .....

1. Ratemeter. Single input, fully scalable
2. Totaliser - simple single input counter
3. Gated Totaliser
4. Single input up/down counter
5. Dual input up/down counter
6. Dual input up/up counter
7. Quadrature counter
8. Chronometer/timer
9. Run timer
10. Period meter / bake timer

Each mode is described in more detail over the following pages....

## 1. RATE (Max. Frequency 50Khz. applied to Input 1 only)

The 'Rate' LED will light in this mode.

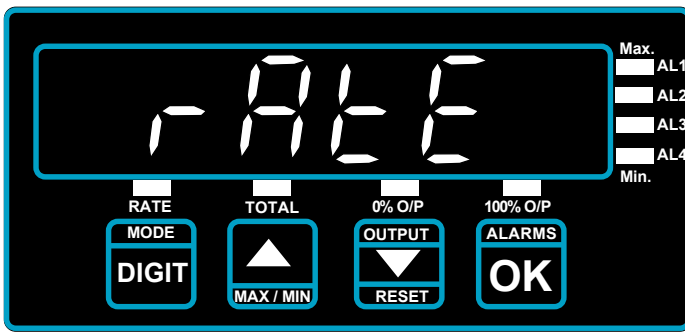

Press OK when you see this prompt, if you want to select Ratemeter operation.

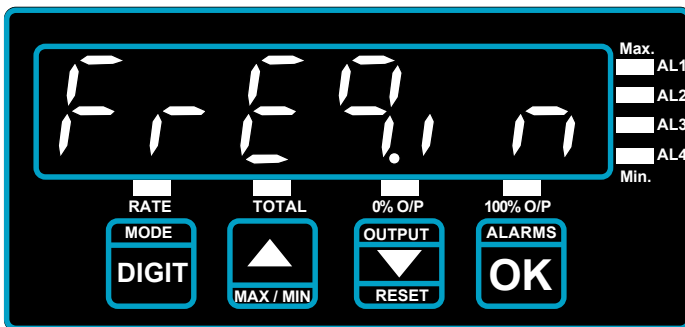

### FREQUENCY IN

This prompt appears for a second or two. Set to the maximum input frequency you will use for your application.

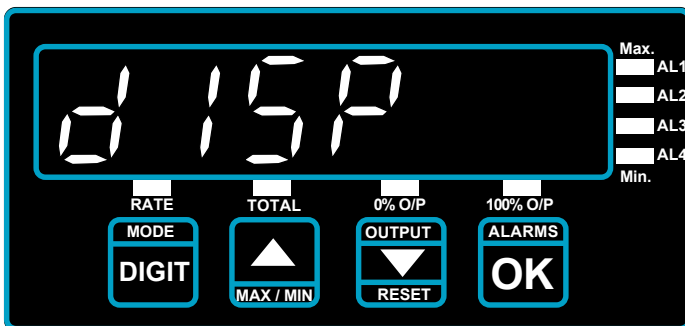

### DISPLAY

This prompt appears for a second or two. Set to the display reading you would like to appear, when the maximum frequency is applied to the meter.

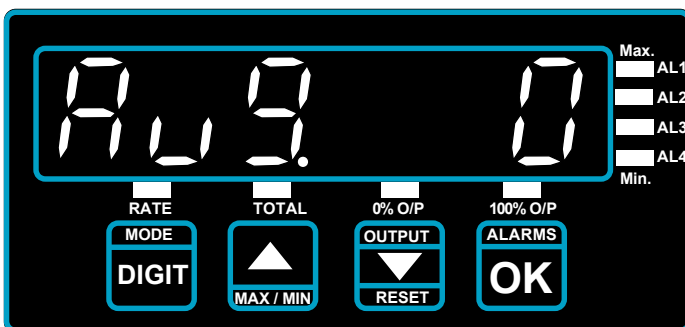

### AVERAGE NUMBER

This value can be altered using the UP and DOWN buttons. It selects the number of readings to be averaged. You can choose values from 0 to 256.

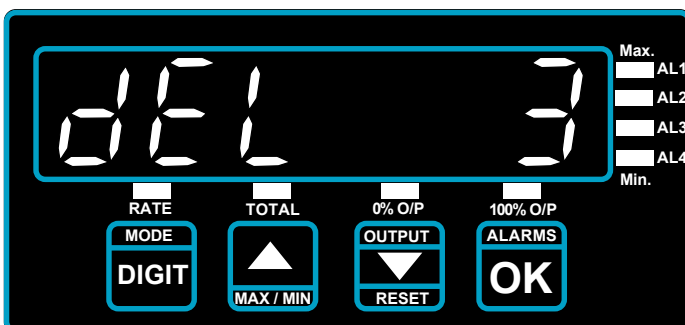

### DELAY VALUE

When signals stop, you can select how many seconds the display will hold the last reading for, before going to 0. You can select either 3, 10, 30 or 60 seconds

See following page for various common scaling examples.

## Rate scaling examples

To measure direct frequency

To read in Hz only	Set Freq.in = 1	Set disp=1
To read in Hz to 1 decimal place	Set Freq.in = 1	Set disp=1.0
To read in Hz to 2 decimal places	Set Freq.in = 1	Set disp=1.00

To read kHz only	Set Freq.in=1000	Set disp=1
To read kHz to 1 decimal place	Set Freq.in=1000	Set disp=1.0
To read kHz to 2 decimal places	Set Freq.in=1000	Set disp=1.00

To measure items per minute, with 1 pulse per item

To read in items/min only	Set Freq.in = 1	Set disp=60
To read in items/min to 1 decimal place	Set Freq.in = 1	Set disp=60.0
To read in items/min to 2 decimal places	Set Freq.in = 1	Set disp=60.00

To measure items per hour, with 1 pulse per item

To read in items/hour only	Set Freq.in = 1	Set disp=3600
To read in items/hour to 1 decimal place	Set Freq.in = 1	Set disp=3600.0

To measure items per 8 hour shift, with 1 pulse per item

To read in items/shift only	Set Freq.in = 1	Set disp=28800
-----------------------------	-----------------	----------------

To measure flow rate from a sensor.

First, you need to know how many pulses the sensor produces for each unit of volume. Let's assume you have a sensor giving 400 pulses per litre. Let's assume that the maximum flow rate is 65 litres per minute, and you want to display in litres per minute. The first task is to convert this to a frequency, so that you can set **freq.in**

$$F=(400 \times 65) / 60 = 433.33$$

So, **Freq.in** = 433.33 and **disp** = 65

**For all scalings, the method is simple:**

1. Work out what frequency (in Hertz) the sensor will be producing at the desired display value.
2. Enter this frequency in **freq.in** and the desired display value in **disp**.

For erratic frequencies, you can improve display stability by increasing the value of Avg (the averaging sample)

## 2. Totaliser 50 kHz. max.

This is a simple single input fully scalable totaliser. The 'Total' LED will light in this mode.

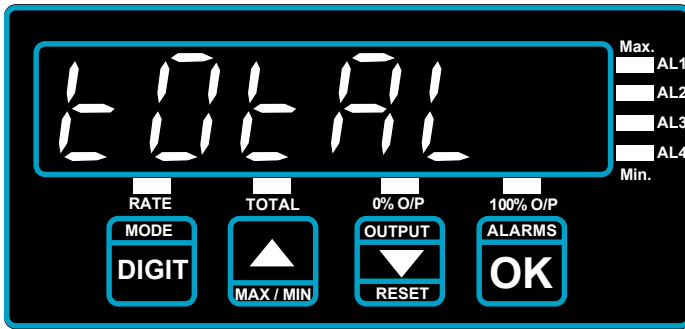

Press OK when you see this prompt, if you want to select simple totaliser operation.

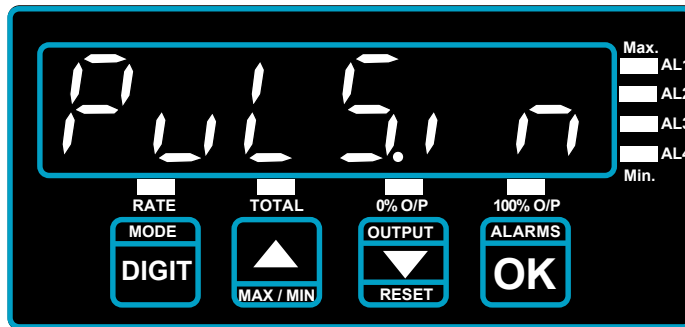

### PULSES IN

This prompt appears for a second or two. Set it to a certain number of pulses appropriate to your application.

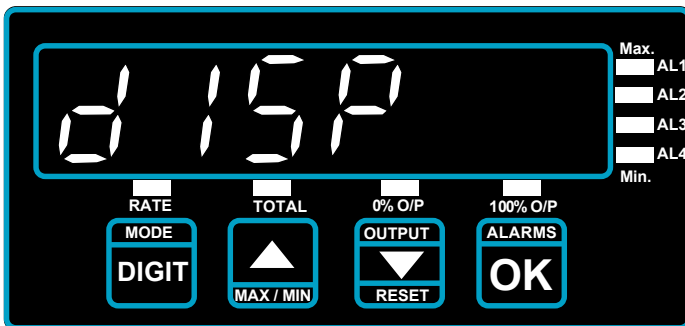

### DISPLAY

This prompt appears for a second or two. Set to the display reading you would like to appear, when the number of pulses you set in the previous step are applied to the meter.

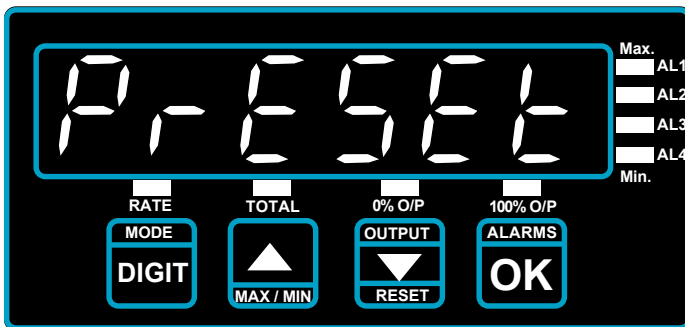

### PRESET

Useful if you are replacing a counter which has accumulated a count, and you wish to transfer this value to your new meter. Presets a starting value.

### Example:

You have a flow sensor giving 350 pulses per litre and you want to display total litres flowed.

Set **PulS.in** = 350

Set **disp** = 1 (or 1.0 , or 1.00 , etc., depending on required resolution) The decimal point can be set after you have used DIGIT to select left hand digit.

### 3. Gated Totaliser 5 kHz. max.

Counts pulses on input 1 *only* if Input 2 logic level is low (inhibits when high).  
The 'Total' LED will light in this mode.

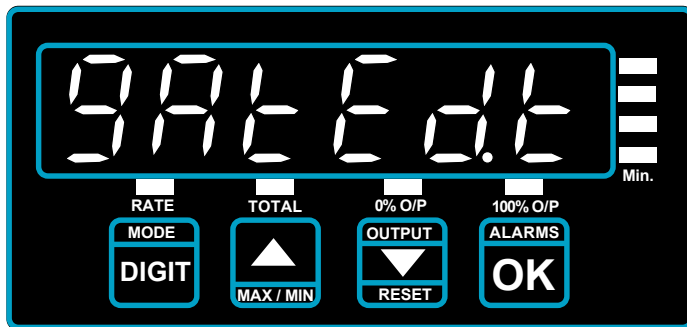

Press OK when you see this prompt, if you want to select gated totaliser operation.

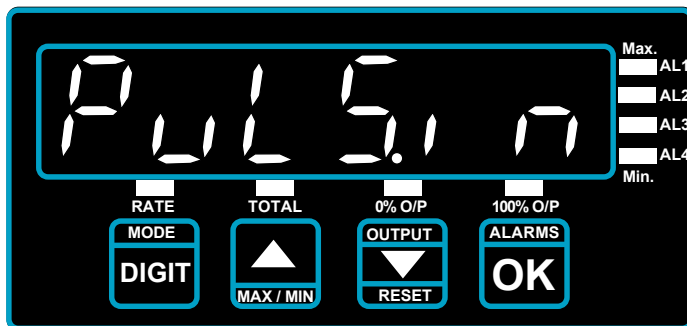

#### PULSES IN

This prompt appears for a second or two. Set it to a certain number of pulses appropriate to your application.

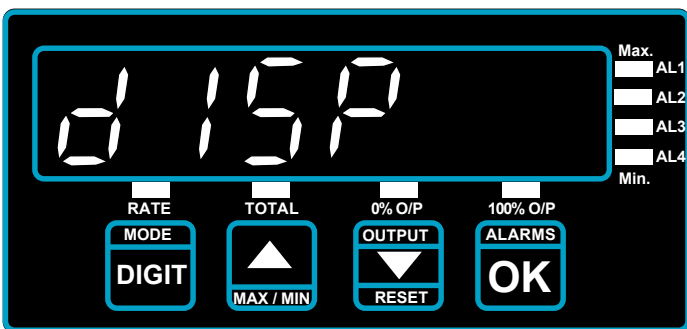

#### DISPLAY

This prompt appears for a second or two. Set to the display reading you would like to appear, when the number of pulses you set in the previous step are applied to the meter.

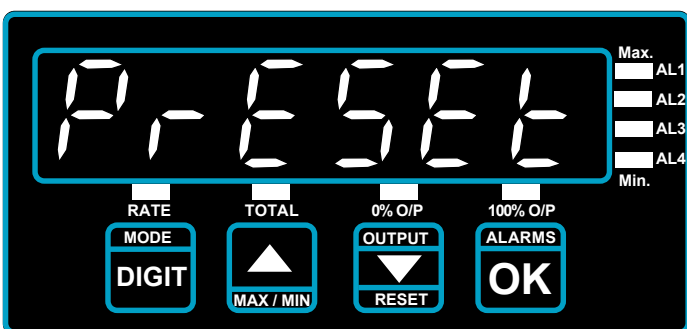

#### PRESET

Useful if you are replacing a counter which has accumulated a count, and you wish to transfer this value to your new meter. Presets a starting value.

#### Example:

You want to count how many items on your production line have been rejected because they were manufactured outside specified temperature limits.

Set **Puls.in** = 1, Set **disp** = 1. Connect pulses from proximity sensor, detecting products, into Input 1 (1 pulse per item). Connect temperature alarm signal into input 2.

#### 4. Single input UP/DOWN totaliser with direction input. 5kHz. max.

Adds pulses on Input 1 when input 2 is high, and subtracts when input 2 is low. The 'Total' LED will light in this mode.

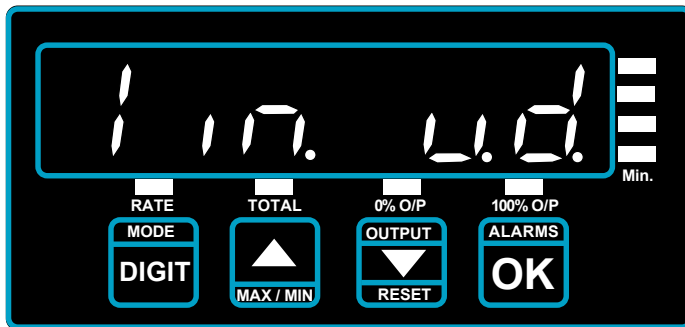

Press OK when you see this prompt, if you want to select single input up/down totaliser operation.

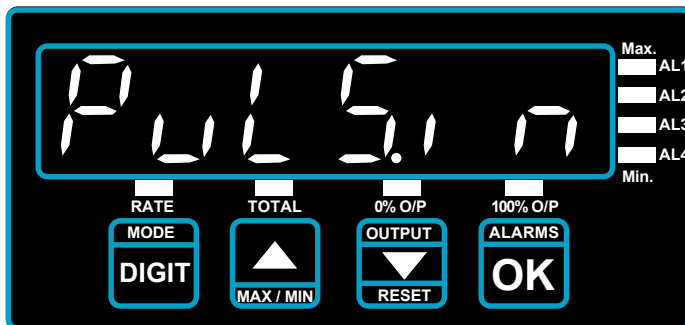

#### PULSES IN

This prompt appears for a second or two. Set it to a certain number of pulses appropriate to your application.

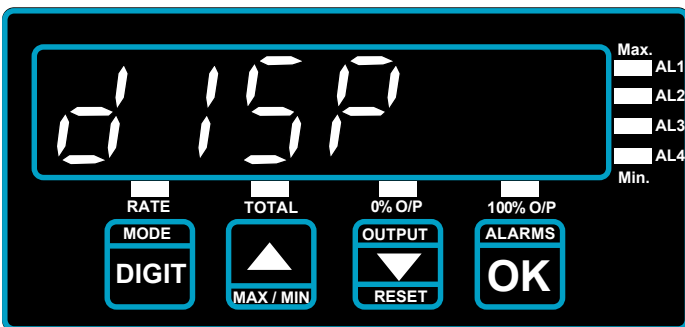

#### DISPLAY

This prompt appears for a second or two. Set to the display reading you would like to appear, when the number of pulses you set in the previous step are applied to the meter.

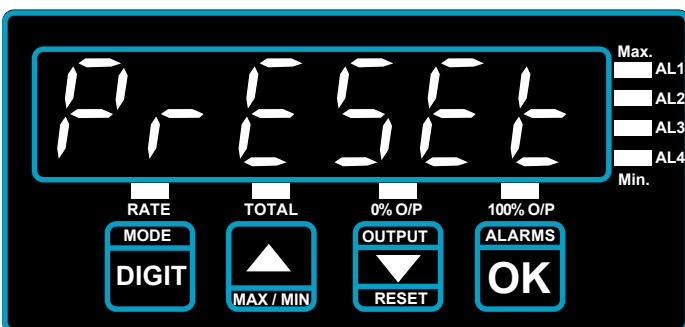

#### PRESET

Useful if you are replacing a counter which has accumulated a count, and you wish to transfer this value to your new meter. Presets a starting value.

Example:

Your motorised satellite dish provides 70 pulses per degree of movement. It also provides a logic high when moving clockwise, logic low when moving anti-clockwise. You want to display from 0 to +90 degrees elevation.

Set **Puls.in** = 70 , **disp** =1. Connect movement pulses into input 1. Connect direction level into input 2. Set dish to 0 degrees and reset display to 0.

## 5. Dual input UP/ DOWN totaliser. Max. pulse frequency 5kHz.

Pulses received at input 1 count up, pulses received at input 2 count down.  
The 'Total' LED will light in this mode.

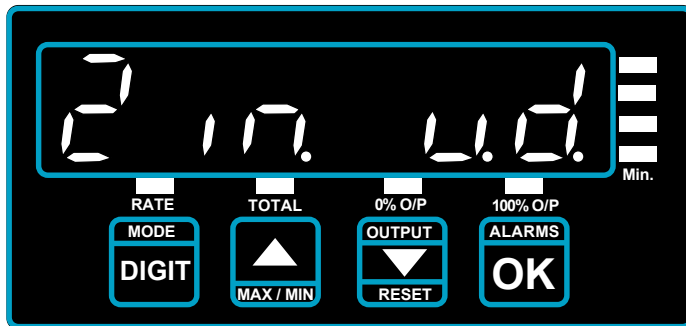

Press OK when you see this prompt, if you want to select dual input up/down totaliser operation.

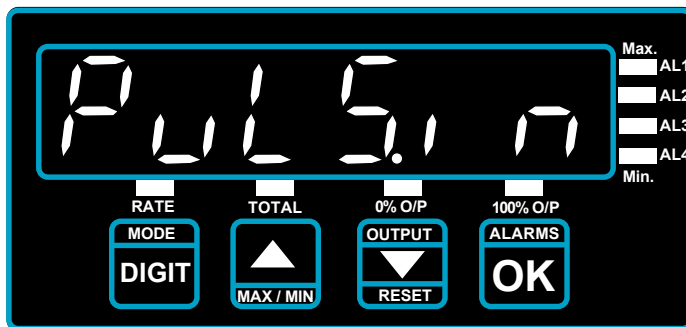

### PULSES IN

This prompt appears for a second or two. Set it to a certain number of pulses appropriate to your application.

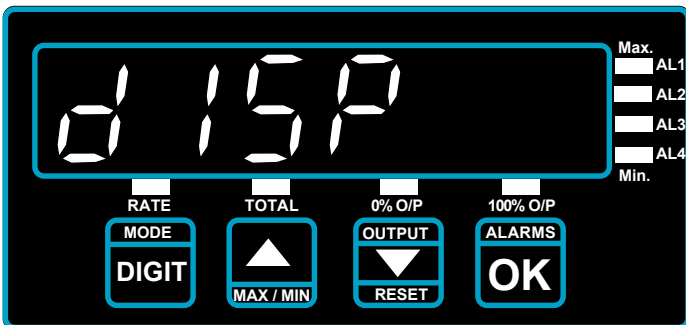

### DISPLAY

This prompt appears for a second or two. Set to the display reading you would like to appear, when the number of pulses you set in the previous step are applied to the meter.

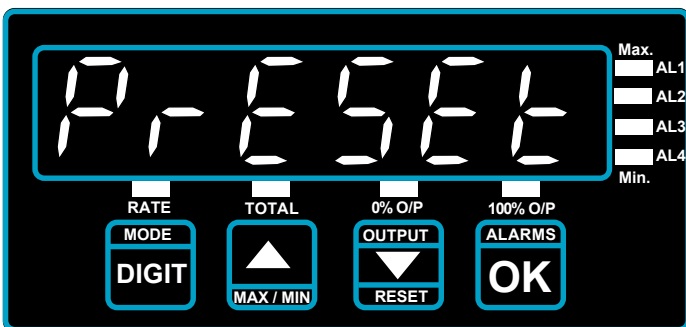

### PRESET

Useful if you are replacing a counter which has accumulated a count, and you wish to transfer this value to your new meter. Presets a starting value.

Example:

You want to display the total number of people in a building at any time. There are 2 turnstiles, one for people entering, the other for people leaving. A sensor on each turnstile connects to each input of the display. Set **PULS.in**=1, set **disp** =1. Set **Preset** to the number of people already in the building. The meter can accept an up and down pulse at the same time, without error.

## 6. Dual input UP/ UP totaliser. Max. pulse frequency 5kHz.

Pulses received on both inputs are counted and scaled together.  
The 'Total' LED will light in this mode.

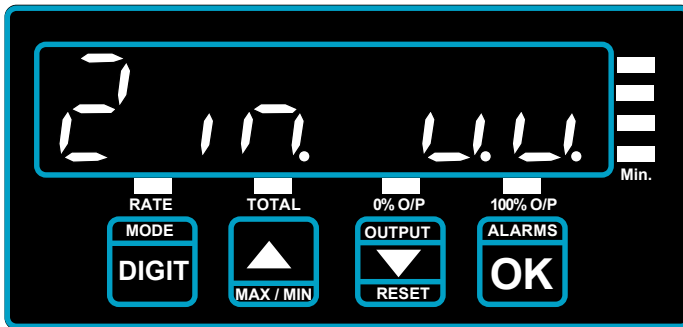

Press OK when you see this prompt, if you want to select dual input up/up totaliser operation.

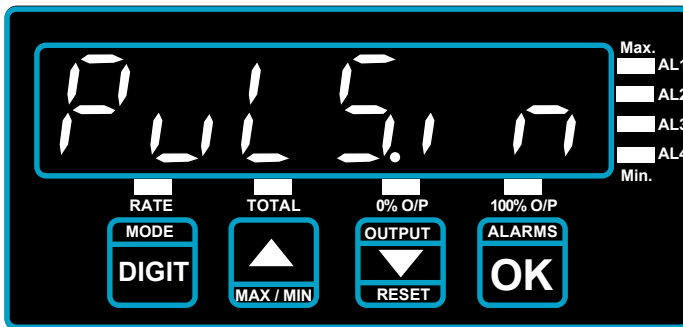

### PULSES IN

This prompt appears for a second or two. Set it to a certain number of pulses appropriate to your application.

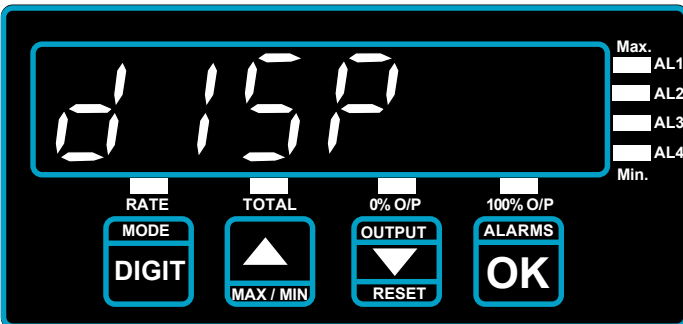

### DISPLAY

This prompt appears for a second or two. Set to the display reading you would like to appear, when the number of pulses you set in the previous step are applied to the meter.

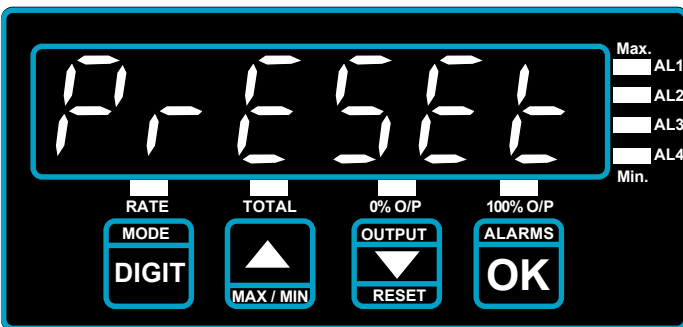

### PRESET

Useful if you are replacing a counter which has accumulated a count, and you wish to transfer this value to your new meter. Presets a starting value.

Example:

You want to display the total number of items produced from 2 production lines. Each line has a sensor producing 1 pulse per item.

Set **Puls.in**=1, set **disp** =1. The meter can accept pulses on both inputs at exactly the same time, without error.

## 7. Quadrature totaliser . Max. pulse frequency 2.5kHz.

Accepts A+B quadrature for distance/angle and direction measurements.  
The 'Total' LED will light in this mode.

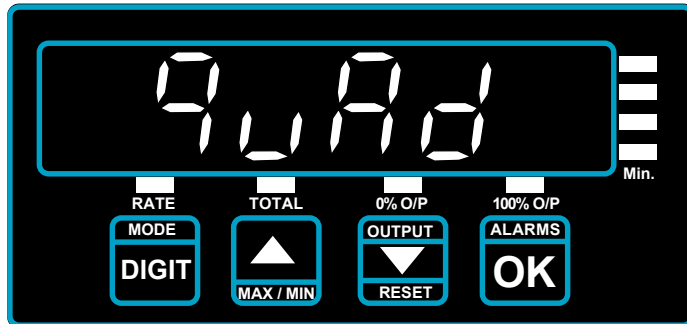

Press OK when you see this prompt, if you want to select quadrature totaliser operation.

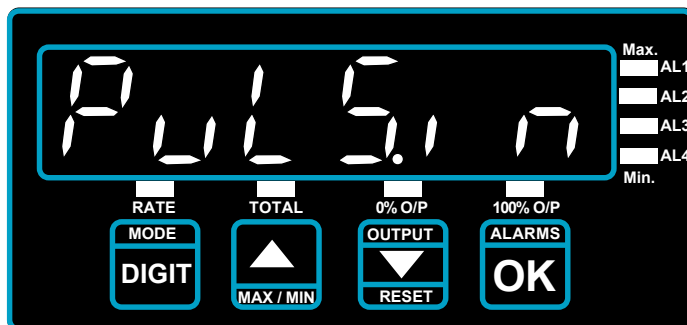

### PULSES IN

This prompt appears for a second or two. Set it to a certain number of pulses appropriate to your application.

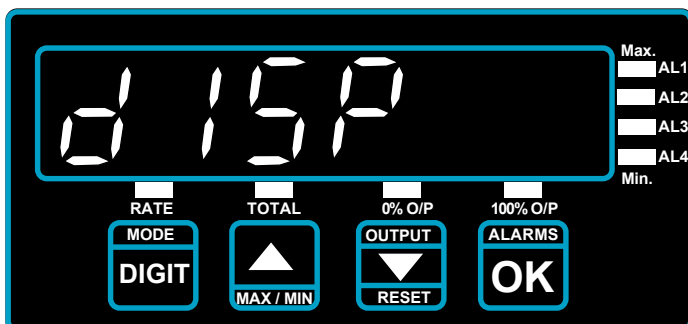

### DISPLAY

This prompt appears for a second or two. Set to the display reading you would like to appear, when the number of pulses you set in the previous step are applied to the meter.

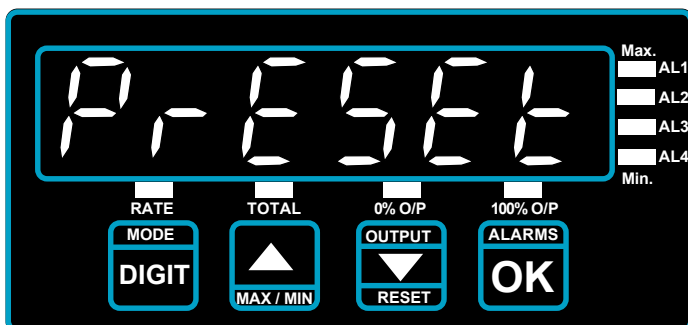

### PRESET

Useful if you are replacing a counter which has accumulated a count, and you wish to transfer this value to your new meter. Presets a starting value.

Example:

You have a quadrature encoder with 1000 pulses per revolution on a 20cm circumference wheel. You want to measure distance the wheel has travelled, in metres.

Set **puls.in** = 1000 Set **disp** = 0.2. **Preset** would be set to zero if you want to start your measurements from zero.

## 7. Chronometer

Contact closure on I/P 2 starts timing, closure on Input 1 stops timing. Set switches for NPN input. The 'Total' LED will flash in this mode.

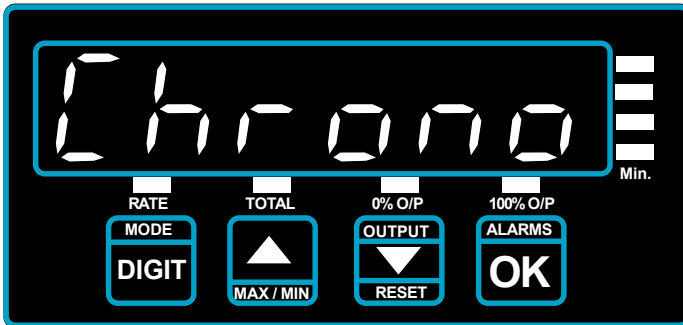

Press OK when you see this prompt, if you want to select chronometer operation.

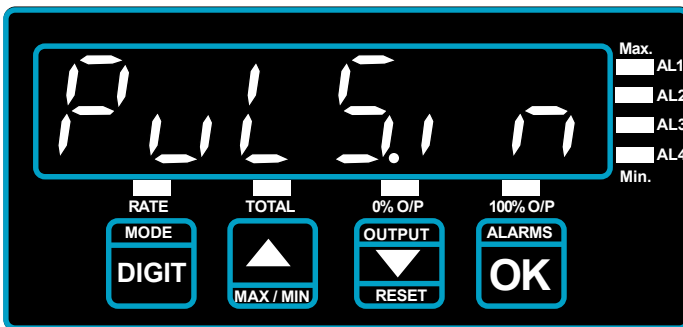

**PULSES IN** (1/100ths of secs)  
This prompt appears for a second or two. Set it to a certain number of pulses appropriate to your application.

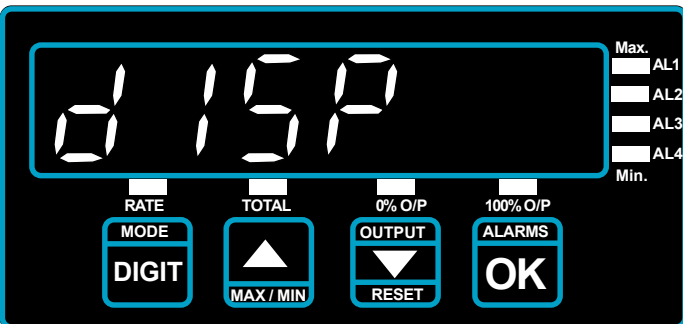

**DISPLAY**  
This prompt appears for a second or two. Set to the display reading you would like to appear.

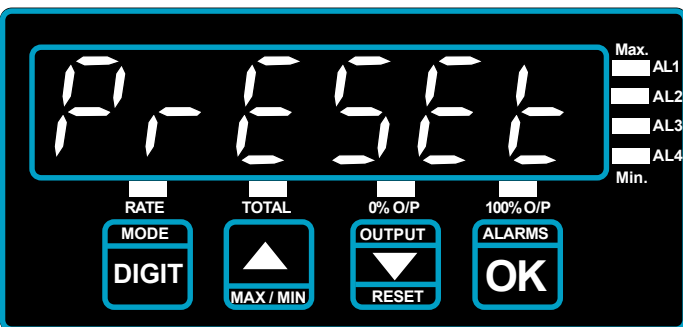

**PRESET**  
Presets a starting value.  
Normally set to 0

### Examples

1. You want to count in seconds.

Set **puls.in** = 100 Set **disp** = 1 to count in whole seconds, 1.0 for tenths, etc.

1. You want to count in minutes.

Set **puls.in** = 6000 Set **disp** = 1 to count in whole minutes, 1.0 for tenths, etc.

**2. You want to count in hours**

Set **puls.in** = 360000 Set **disp** = 1 to count in whole hours, 1.0 for tenths, etc.

## 7. Run time display

Contact closure on I/P 1 starts timing, opening on Input 1 stops timing. Set switches for NPN input. The 'Total' LED will light in this mode.

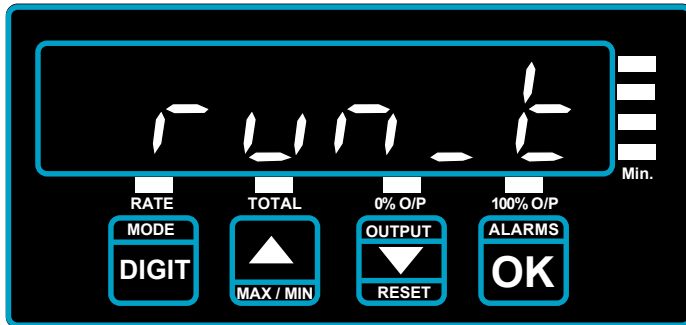

Press OK when you see this prompt, if you want to select run timer operation.

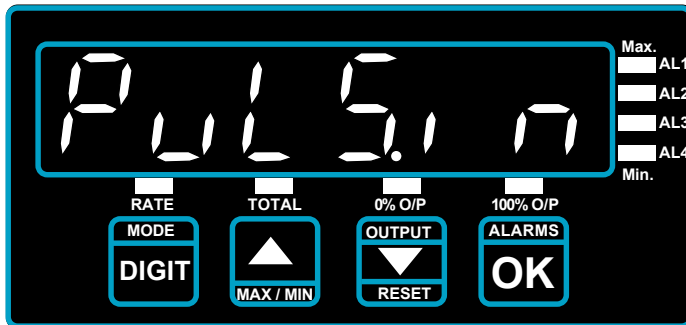

**PULSES IN** (1/100ths of secs)  
This prompt appears for a second or two. Set it to a certain number of pulses appropriate to your application.

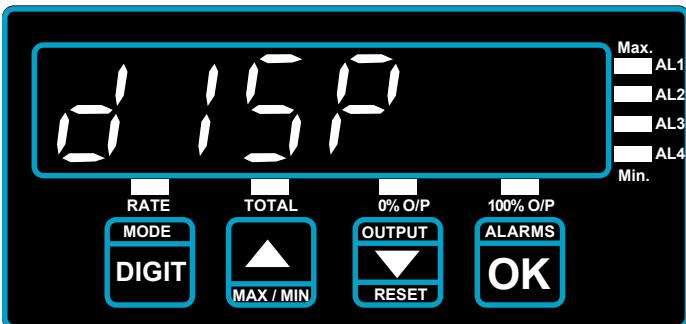

**DISPLAY**  
This prompt appears for a second or two. Set to the display reading you would like to appear.

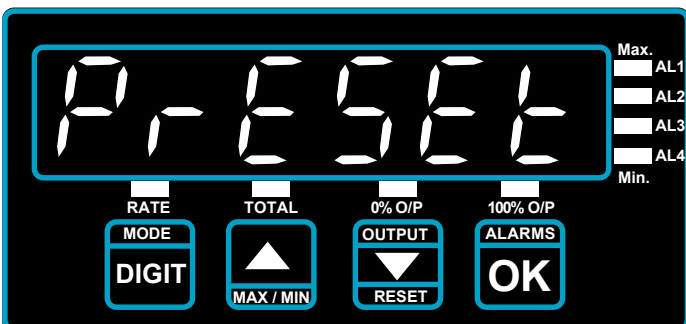

**PRESET**  
Presents a starting value.

### Examples

1. You want to count in seconds.

Set **puls.in** = 100 Set **disp** = 1 to count in whole seconds, 1.0 for tenths, etc.

1. You want to count in minutes.

Set **puls.in** = 6000 Set **disp** = 1 to count in whole minutes, 1.0 for tenths, etc.

2. You want to count in hours

Set **puls.in** = 360000 Set **disp** = 1 to count in whole hours, 1.0 for tenths, etc.

## 7. Period / Bake time

Accepts pulses on input 1. Displays period / scaled time. (inverse of frequency)  
The 'Rate' LED will light in this mode.

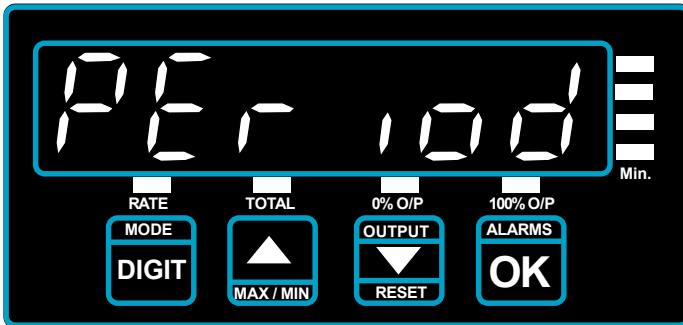

Press OK when you see this prompt, if you want to select period / bake timer operation.

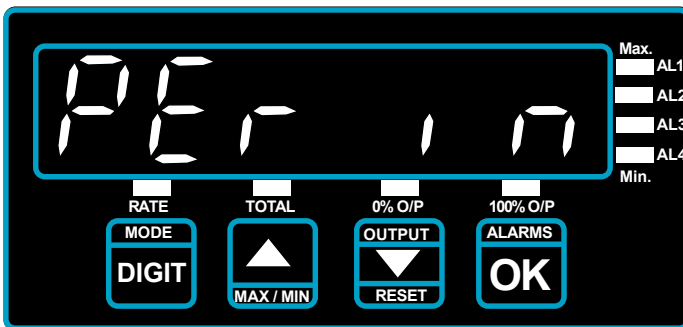

**Period In (milliseconds)**  
This prompt appears for a second or two. Set it to the number of milliseconds of a typical input period in your application

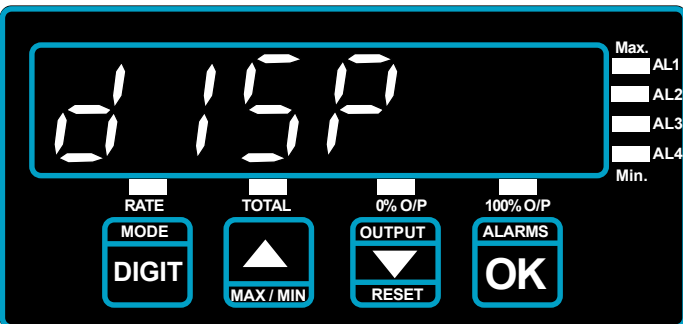

**DISPLAY**  
This prompt appears for a second or two. Set to the display reading you would like to appear, when the pulse period you set in the previous step is applied to the meter.

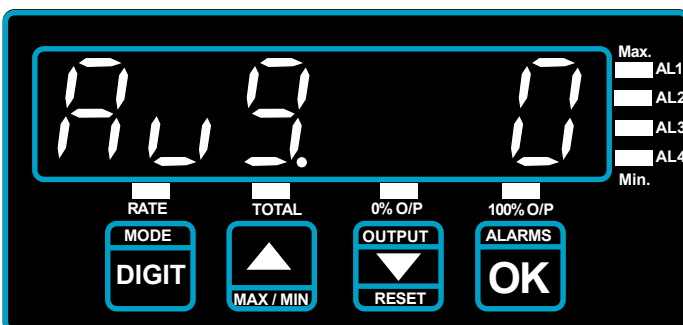

**AVERAGE**  
For repetitive pulse inputs, you can choose to have the reading derived from the average of a number of pulses

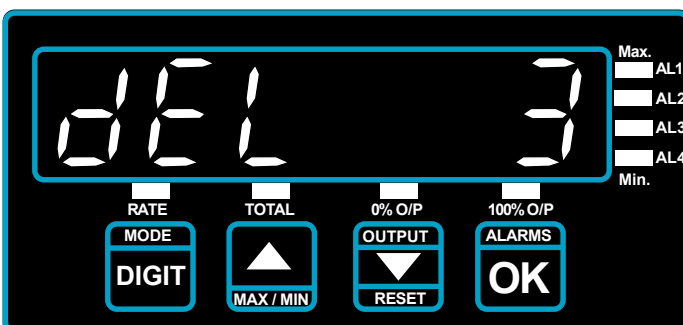

**DELAY**  
You can use this setting to cause the display to fall to 0 if no pulses arrive within a given time - shown here as 3 seconds.

## Some worked examples of bake time and period setup..

1. You want to measure the period of a pulsetrain in **milliseconds**

Set **puls.in = 1** Set **disp = 1** **Avg = 0** **dEL=3**

2. You want to measure the period of a pulsetrain in **seconds**

Set **puls.in = 1000** Set **disp = 1** **Avg = 0** **dEL=60**

3. You want to measure bake time. Your conveyot is driven by a variable speed drive which produces 1440Hz when the bake transit time of the conveyor belt is 20minutes. You want to display bake time in minutes, to 1 decimal place

First, find the period of the incoming pulse train ...

$$\text{Period} = 1/1440 \text{ mS} = 0.6444\text{mS}$$

Now, set **puls.in = 0.6444** mS Set **disp = 20.0** **Avg=4** to smooth display. Set **dEL=3**

If conveyor jitter causes the display to fluctuate, you can increase the Averaging number to reduce this effect.

# Special Features

## **Peak and Valley detection (RATE mode only)**

The latest frequency measurement is compared to previous maximum and minimum measurements. The meter updates the peak or trough memory, if required with the new value. There are 2 ways you can view the stored peaks or valleys, either by the front panel pushbuttons or by external contact closure.

Peak is annunciated on the display by the 'MAX' bar flashing (identified as 'AL1' on the front panel)

Valley is annunciated on the display by the 'MIN' bar flashing (identified as 'AL4' on the front panel). The selection of actual reading, peak and valley is sequential.

## **How to view Peak/Valley using the MIN/MAX button on the front lens**

- 1) The lockout switch must be ON
- 2) Link terminal 7 to terminal 9
- 3) Press UP arrow key for peak, valley, normal

## **How to view Peak/Valley by using a remote contact closure**

- 1) The lockout switch must be ON
- 2) Connect a normally-open contact closure switch between terminals 7 and 9

## **Reset Command**

The reset command clears any stored peak or valley data, samples of previous rate measurements, being used in the Averaging calculation, and any accumulated total and may be accessed either from the front panel or by external contact closure command.

## **How to reset the meter by pressing the front panel 'RESET' button**

- 1) The lockout switch must be ON
- 2) Link terminal 7 to terminal 10
- 3) Press Down Arrow key to reset display

## **How to reset the meter with a remote contact closure**

- 1) The lockout switch must be ON
- 2) Connect a normally-open contact closure switch between terminals 7 and 10

# Error Messages

Certain conditions may arise which fall outside the capability of the meter, and these conditions are announced with error messages as follows:-

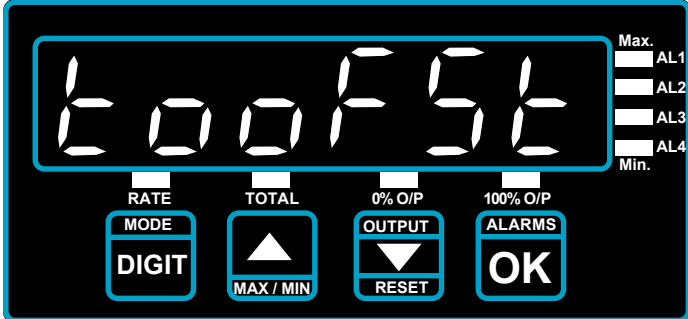

“Too Fast” = The input signal frequency is higher than the meter can accept. Reduce input frequency or use a signal source (encoder etc.) with lower output rate.

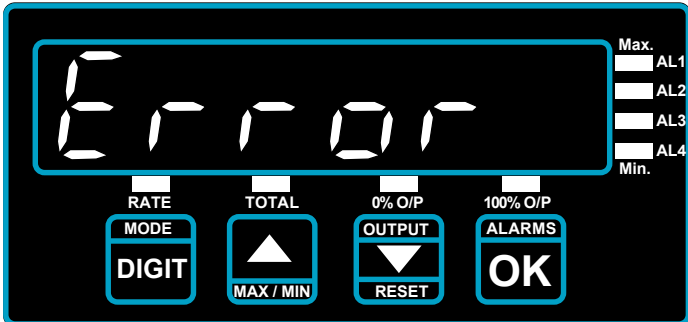

“Error” =Microprocessor error. There may be a fault in the meter, or the meter has been unable to perform a computation. The scale factor may be set to a value beyond the capability of the meter.

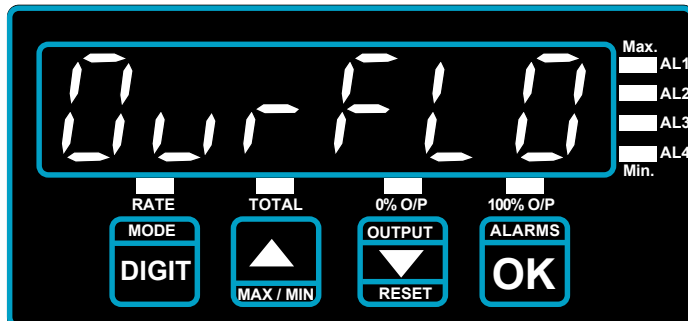

“Overflow” = The counter has reached or exceeded its capacity of 999999. If this occurs earlier than desired, consider dividing the count by 100, or 1000 and use either 2 or 3 decimal places, and label the reading ‘X 100’ or ‘X 1000’

# How to install option boards

If you want to open the meter to install or modify option boards, follow these steps...

- 1) Switch off power to the meter and unplug all connectors.
- 2) Unclip the front bezel. This is easier if you squeeze the top and bottom of the case, near the front.
- 3) Remove the small screws shown in the diagram. If the meter doesn't yet have an output option board, the top screw may not yet be fitted.
- 4) Slide the electronic boards out through the front of the case. You can easily separate the upper option board from the main board. We strongly suggest that you use anti-static precautions to prevent damage to the semiconductors.

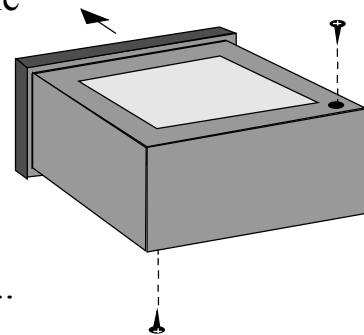

The board assemblies will look something like this...

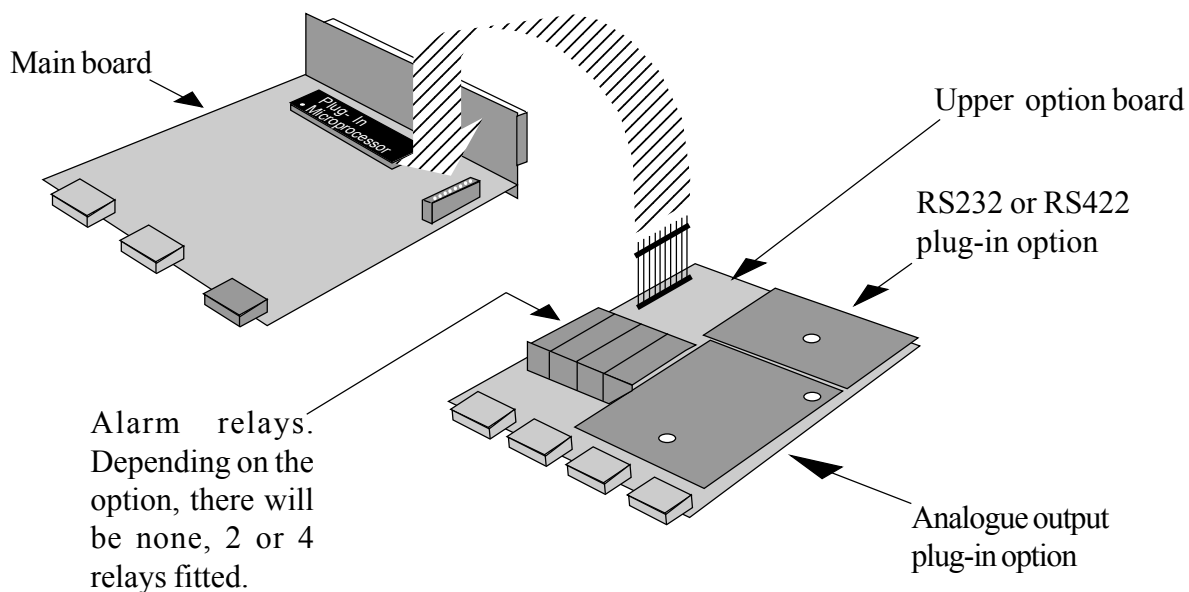

The analogue output and RS232 or RS422 plug-in option boards are fixed to the upper option board with white plastic pillars. You must apply a firm force when fitting or removing these options.

Always be careful to connect the pins to sockets accurately. When reassembling, make sure option boards are firmly fixed to the upper option board. When the boards are replaced in the case, secure them again with the two small black screws.

# Alarm Board Configuration & Adjustment

For failsafe operation (where contacts open on alarm or when power is lost to the meter) set the jumpers for OPEN CONTACTS and DE-ENERGISE on alarm. This is the factory default setting.

To access the alarm board, first remove power from meter, including any power which might be on the alarm output circuitry.

Look on the top and bottom surfaces of the case, near the rear. You will see two small screws, one on each surface. Remove both screws. Now, clip off the front bezel and slide the meter assembly carefully out via the front of the case.

The relay board plugs into the main board. Gently separate the two boards.

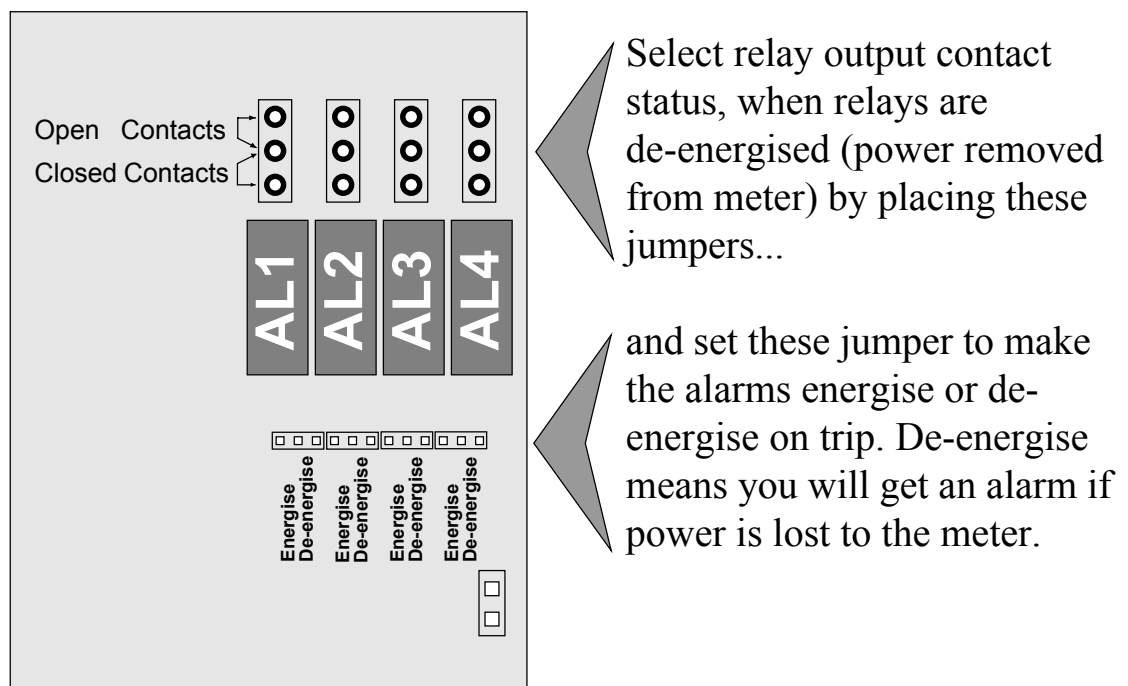

When you have set the jumpers, refit the board to the meter and carefully slide the assembly back into the case.

Fit the two small board screws to the top and bottom surfaces.

## Alarm settings

### NOTE : totalisation stops during alarm adjustment

If you press the ALARMS button momentarily, you can view each of the 4 alarm settings (each press will illuminate in turn AL1, AL2, AL3 and AL4 LEDs). alarm settings are not locked out by the lockout switch.

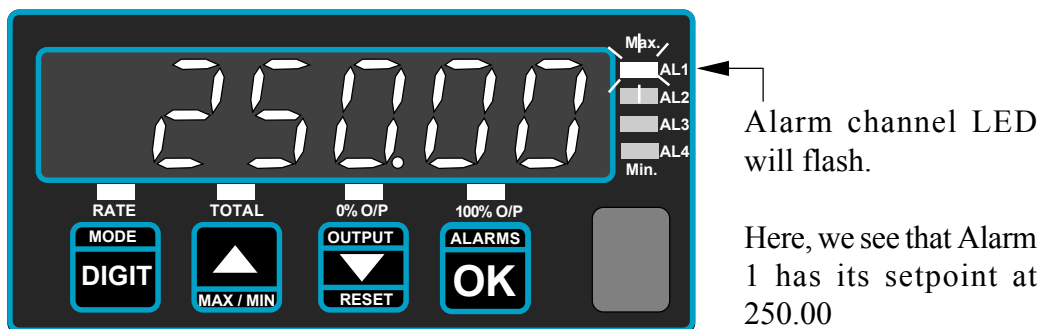

To change alarm settings, select the alarm you wish to change as shown above until its LED is flashing, then press the ALARM key for more than 3 seconds. You will see one digit is brighter than the others. You can change its value using the UP/DOWN buttons, and then select other digits with the DIGIT SELECT pushbutton. When the value has been set, press OK.

The alarm action is now displayed. This will show 'HI' for HIGH alarm action, 'LO' for LOW alarm action, or 'off' for NO alarm action. You can change this with the UP/DOWN buttons. Press OK when set.

The HYSTERESIS value is identified with a 'HY' prompt, and you can change this to suit your requirements.

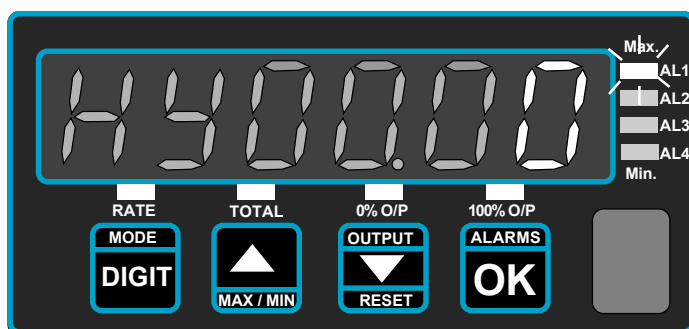

The hysteresis value is directly related to your measurements, so, for example, if you have a high alarm, set to 500, and set the hysteresis value to 7, the alarm will occur when the meter reading rises above 500, and will reset when the meter reading falls to 493.

## Analogue Output Configuration

We always set the meters to suit any requests on your order, so you should not need to adjust the analogue board. If you didn't specify ranges, but ordered option 'ANI', the meter will be set for 4-20mA output. If you ordered 'ANV' it will be set for 0-10V.

If you want to change a range, for example from 0-10V to 4-20mA, the zero and span potentiometers must be adjusted to get best accuracy at 0% and 100%.

You will need to remove the analogue board from the case to change the position of jumpers and to adjust the fine trim potentiometers. See the page headed "How to fit Option Boards" for details of how to expose this board. The analogue board, if fitted, can be seen plugged into the upper board, and can be easily identified because it has either 2 or 3 blue potentiometers, depending on version.

You will need to carefully unplug the analogue output board from the upper board and change the jumper positions to suit your new range, as shown below.

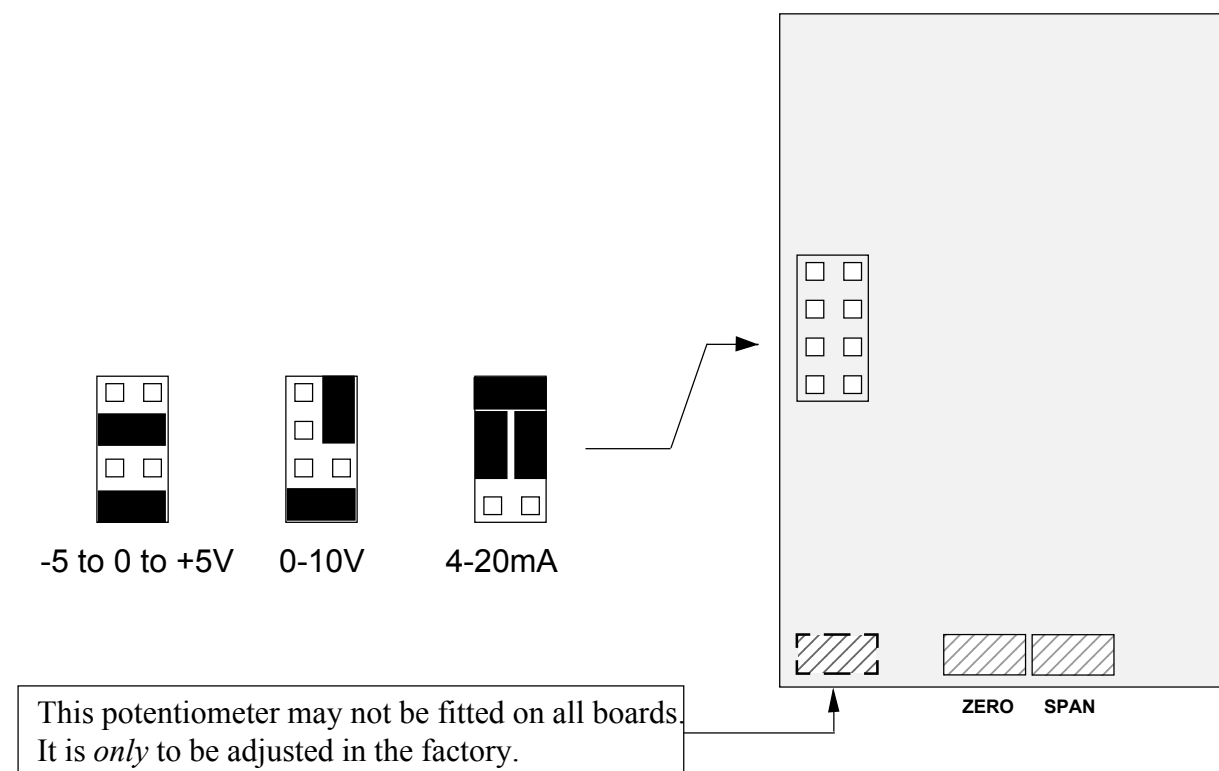

Re assemble the meter, apply power and follow the Analogue Output Settings procedure on the next page. Measure the analogue output and trim, if needed, using the ZERO and SPAN potentiometers, for best accuracy.

# How to adjust your Analogue Output

**NOTE : totalisation stops during analogue output adjustment**

The lockout switch should be set 'OFF' to change the analogue output calibration. You can set the analogue output range to suit your display range.

The analogue output can be directly proportional or inversely proportional to the display range, for example you can have 4-20mA output for display 0 to 100 or for display 100 to 0.

- 1) Press 'OUTPUT' button for 3 seconds
- 2) 0% O/P LED should flash
- 3) Set the display for the reading value where you want 0% Output, by using DIGIT and UP/DOWN buttons

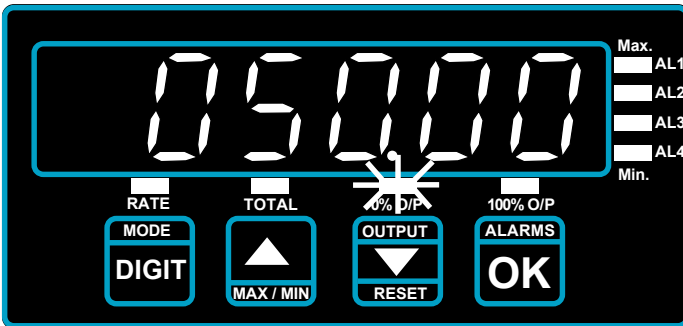

Jumpers on Analogue Board	0% gives
4-20mA	4mA
0-10V	0 V
-5 to +5V	-5V

So in this example, if you set the jumpers for 4-20mA, you will get 4mA output when the display is 50.00

- 4) When set, press the OK button.
- 5) Now the 100% O/P LED should flash
- 6) Set the display to the reading value where you want 100% Output, by using DIGIT and UP/DOWN buttons

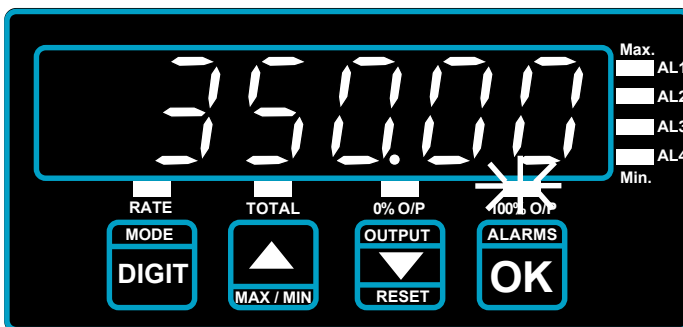

Jumpers on Analogue Board	100% gives
4-20mA	20mA
0-10V	10 V
-5 to +5V	+5V

So in this example, if you set the jumpers for 4-20mA you will get 20mA output when the display is 350.00

- 7) When set, press OK, to complete your adjustment of the analogue output scaling

**Please remember to set the lockout switch 'ON' to save your settings.**

## Serial Communications Output Option

You can have either an RS232 or an RS422 ASCII output at 1200 baud representing the meter's displayed value. You can have a continuous transmission of readings, or a single transmission on demand.

RS232 O/P on terminal 16 (data+) and terminal 18(common)

RS422 O/P on terminals 16 & 17(Data + and -) and 18 (common)

### String Format:

ASCII coded numerals, with embedded decimal point position if one has been set on the display, with a preceding - sign if the display is negative, with leading zero blanking, followed by a Carriage Return and a Line Feed. 9 characters will be sent if the meter is in RATE mode, 10 characters if it is in TOTAL mode.

So, for a displayed value of...

12345 string is <space><space><1><2><3><4><5><CR><LF> for rate ...  
or <space><space><space><1><2><3><4><5><CR><LF> for  
total.

-15.0 string is <space><space><-><1><5><.><0><CR><LF> for rate ...  
or <space><space><space><-><1><5><.><0><CR><LF> for  
total.

### Commands:

The data output port is activated by connecting to the ENABLE terminal.

For RS232, the ENABLE port must be held high at a 5V level for as long as serial data output is required, or, if only one string of data is needed, the ENABLE line must be held high until the transmission starts, after which it may be taken low again. The Sig- connection on terminal 17 may be used to provide the 5V level if an external source is not available. For RS422, the ENABLE port operates in reverse, so must be held low to enable transmission.

If you need a remote mimic display, the Model INTUITIVE-S is an ideal choice, being a 1/8 DIN meter directly compatible with this output format.

Also, we manufacture a range of Large Format remote displays having digit heights of 57mm, 102mm, 144mm, 200mm and 280mm. Ask us about the 1700 Series and the EasyReader Series.

# Equipment Specifications

Bezel size	48mm high by 96 mm wide (1/8 DIN)
Panel Cutout	45 mm high by 92 mm wide
Case Depth	125 mm including connectors
Weight	300 grammes
Case Material	Black polycarbonate
Connectors	Detachable Screw Terminal connectors
Storage temperature	-10 to +70 degrees C
Operating temperature	0 to 50 degrees C
Display	6 digit LED 14.2mm high red or green
Sealing	IP65 from front. Can be upgraded to IP67
Power	95-265 VAC or 11-30 VDC optional, 8VA maximum
Signal Types	NPN, PNP, Dry Contact, AC voltage, CMOS
Minimum Amplitude	100 mV RMS @1kHz. with amplifier activated
Maximum Amplitude	60 V P-P
Minimum frequency	0.03 Hz for rate, no lower limit for totalisation
Maximum frequency	See 'Mode Selection & Scaling' (depends on mode)
Accuracy	Rate +/- 0.01% of input @25°C. +/- 100ppm/°C
Pullup/down	22 Kilohms
Excitation voltage	24 VDC typ.100mA max.@23 Deg. C, 60mA max. at 50 deg. C. Noise<100mV<100Khz.
Debounce action	Enabled by rear switches. 30 Hz. Cutoff.
Totalisation memory	10 years EEPROM. Note: When switching meter off, the power must drop to 0 in <200 mSeconds for data to be saved properly.

<b>ANALOGUE O/P</b>	0-10VDC	4-20mA	+/-5VDC
Drive capacity	>1K Ohms	<500 Ohms	>1 K Ohms
Isolation	250 VAC Optically isolated		
Accuracy	+/-0.1% range, +/-10mV for ANV, +/-10uA for ANI		
Linearity	+/-0.02% of range		
Resolution	12 bits		
Scaling	Fully adjustable, direct or inverse		
Update rate	1 conversion every 570mS for ratemeter, if $F_{in} > 1.5\text{Hz}$ . 10 conversions/sec for totaliser		

**ALARM O/P** 4 alarms SPST rated 5 Amperes at 250 VAC resistive  
May be set as HI or LO , with variable hysteresis.

**ASCII O/P** RS232 or RS422 transmission of reading. 1200 baud  
Isolation 250 VAC optically isolated

# Record of Revisions/Changes

25 April 2000	Version 6.6 software released. Manual modifies as follows:-
	Page 3 Specification for Totalisation memory. Added note requiring power to be removed within 200mS to allow correct count SAVE function.
	Page 7 Added note explaining that totalisation will not occur during the setup routine for alarm outputs.
	Page 8 Added note explaining that totalisation will not occur during the setup routine for analogue output.
13 June 2000	Ver C/F1.0 software released. Internal bug analogue output eliminated
7 August 2000	Page 3 Minimum amplitude increased from 20mV RMS to 100 mV RMS
20 March 2001	Page 3 Correction to pull-up text - Revision P3 cards only
	Page 4 Removal of jumpers on PNP and AC and addition to PNP Sensor inputs for fitting of 3K3 resistor between signal inputs and signal common - Revision P3 cards only
	Page 11 Correction of Declaration
27 April 2001	Rev. 6 manual released
	Page 4 Selection switches and pullup resistor details updated.
	Page 5 Changed references from jumpers to switches.
	Page 6 Changed references from jumpers to switches.
	Page 8 Changed references from jumpers to switches.
4 June 2001	global Rev. 7 Manual released Reformatted with larger text and additional supporting diagrams
2 Oct. 2001	Page 21 Rev 8 manual released. Analogue output page updated to show new potentiometer layout.
10 March 2003	Page 6 Sensitivity choices updated. Reformatted connection chart.
31 July 2003	back Declaration of Conformity amended
3 March 2004	page 23 Changed reference from Grand Intuitive to EasyReader
16 March 2004	Pages 16,17,18 - Added 3 new functions Chrono, Run time and Period
28 July 2004	Pages 16,17,18 - Clarified functions of Rate and Total LEDs for Chrono, Run-time and period. Corrected 'Rate' and Total' LED illumination bug.

# Declaration of Conformity

Declaration Reference : INTUITIVE  
Issue Date : 9 October 1998 revised 31 July 2003  
Products Covered : INTUITIVE series  
Title : DOC-INTUITIVE

This is to confirm that the Product covered by this declaration have been designed and manufactured to meet the limits of the following EMC Standard :

EN61326-1:1997

and has been designed to meet the applicable sections of the following safety standards

EN61010-1:2001

## Conditions

The meters are permitted a worst case error of 1% of A/D range during electro-magnetic disturbance, and must recover automatically when disturbance ceases without the need for human intervention, such as resetting, power-down etc.

The meters covered by this certificate must be installed in adherence to the following conditions :-

Signal cabling shall be routed separately to power carrying cabling (includes relay output wiring)  
All signal cabling shall be screened. The screen shall only be terminated to the power earth terminal

Declared as true and correct, for and on behalf of London Electronics Ltd.

Warren Court, Beds.

J.R.Lees Director