

# London Electronics Limited

Thorncote Road, Near Sandy, Bedfordshire SG19 1PU  
Tel +44(0)1767 626444 Fax +44(0)1767 626446  
www.london-electronics.com help@london-electronics.com

## Panel mounting process indicator / controller **INTUITIVE-P Mk.2**

### Connection details, scaling and general information



**Caution:** There is a risk of electrical shock if this instrument is not properly installed



**Caution:** Risk of danger: Read the whole manual before you install this meter

#### The New version of the INTUITIVE Family, with these extra benefits...

- \* 20 bit A/D convertor, higher precision, improved stability.
- \* 16 bit D/A convertor, greater resolution.
- \* Direct and theoretical linearisation features
- \* More comms options, for faster, more flexible data access.
- \* Extra 'Factor and Offset' feature, allows you to correct for Gravity, Container Tare etc.
- \* Timers on alarm relays.
- \* More alarm setting modes, including in-band and out of band alarms.
- \* Summary Screen, lets you know which options are fitted, whenever you want to know.
- \* Wider operating temperature range
- \* Variable brightness feature
- \* Adjustable menu timeout delay, to suit new and experienced users.
- \* Outputs selectable from nett or gross.
- \* Real -Time clock option

#### Ordering code: **INT2-P-X-X-X-X-X**

**INT2** = Intuitive Mark 2 family

**P** = Process model

Analogue output: — **0**=none, — **ANI**=4-20mA, — **ANV**=0-10V

Alarm outputs: — **0**=none, — **AL2**= 2 relays, — **AL4**=4 relays

Serial data: — **0**= none, — **232**=RS232, — **485**=RS485

Display colour: — **R**=Red, — **G**=Green

Power: — **AC**=100-240V AC,— **DC**=11-30V DC

Software version **F00.16**

**1**



# Contents

Alarm board configuration	28
Alarm programming	29-35
Analogue output	26-27
Application notes	46,47
Bootup routine	10
Brightness Adjustment	11
Button Functions	12-14
Calibration - introduction	16
Calibration method - direct, no linearisation	17
Calibration method - direct, with linearisation	22
Calibration method - theoretical, no linearisation	18-20
Calibration method - theoretical, with linearisation	21
Connections	9
Declaration of conformity	48
Decimal point setting	12
Excitation voltage - how to reduce	47
Factory Default settings	11
Filtering	15
General Description	6
Gross/Net function	27,28,40,41
Hold function	39,40
Introduction	5
Keyboard timeout Delay	10
Language	10
Logic inputs and MEM-08 option	40,41
Modbus ASCII	38
Mounting and Installation	7
Option boards- installing	25
Real Time Clock setting	39
Record of revisions	44
Reverse / Mirror / Heads-Up display	42
Scale and Offset settings after calibration	24
Serial output option	36-38
Specifications	43
Tare	10,39,40
Timed alarms	29
Warnings	4
WEEE	45
Wiring Advice	8
Zero drift compensation	23

## Warnings

Please carefully read this manual and all warnings. Install the meter ONLY when you are sure that you've covered all aspects.



Where the product is intended for "UL" installations, removal or addition of option boards is not permitted.



Check that the model number and supply voltage suit your application before you install the meter.



Connect the meter according to current IEE regulations, IEC61010 & NFPA:70 National Electric Code in USA.



This meter is for Installation class II service only. This means it has exposed electrical and power terminals. You must install it in a suitable fire enclosure which will also protect users from electric shock



We designed this meter for Pollution-Degree 2 environments only.



Power supplies to this equipment must have anti-surge (T) fuses rated at 400mA for 230V supply, 400mA for 110V supply or 2A for DC supplies in the range 11-30VDC. Only Siba fuses in series 189500, cULus listed according to file #E167295 are accepted for this service under the terms of UL listing .A switch or circuit breaker, clearly marked as a disconnecting device, must be included close to the installation.



Don't touch any circuitry after you have connected the meter, because there may be lethal voltages on the circuit board.



Only adjust on-board switches or connections with the power turned off



Make sure all screw terminals are tight before you switch the meter on.



Only clean the meter's front with a soft damp cloth. Only lightly dampen with water. Do not use any other solvents. The behind-panel case may be cleaned with a dry cloth only, use no liquid or solvent on it.

**Safety First .....Don't assume anything..... Always double check.  
If in doubt, ask someone who is QUALIFIED to assist you in the subject.**

# Introduction

Please contact us if you need help, if you have a complaint, or if you have suggestions to help us improve our products or services.

If you contact us about a product you already have, please tell us the full model number and serial number, so that we can give you accurate and fast help.

This product has a 2 year warranty. We will put right or replace any meter which is faulty because of bad workmanship or materials. This warranty does not cover damage caused by misuse or accident.

## ***IMPORTANT***

If this equipment is important to your process, you may want to buy a spare to cover possible failure or accidental damage in the future.

This is because during factory shutdown periods, you may have to wait several weeks for an equivalent replacement, or we may have no stock at the time you urgently need it.

You may also need to pay extra carriage charges if you want a fast, guaranteed courier service. Warranty repairs or replacements are usually returned with a standard courier service.

We do not offer compensation for losses caused by failure of this instrument.

If you do not agree with these conditions, please return this item in unused, condition, in its original packaging and we will refund the purchase price, excluding any carriage paid.

We thought you'd prefer to know about possible delays and extra charges now, rather than during a panic. A spare unit could help to avoid these issues.

We always try to improve our products and services, so these may change over time. You should keep this manual safely, because future manuals, for new designs, may not describe this product accurately.

We believe these instructions are accurate, and that we have competently designed and manufactured the product, but please let us know if you find any errors.

# General Description

This series of meters accepts industrial sensors to allow various physical measurements to be made, such as weight, temperature, pressure, humidity etc. Different models are available for different sensor types.

The main function of this series is to give a numeric readout of the variable being monitored. Most models include an excitation power output, to power the sensor directly.

Various optional output modules are also available to give alarm relay outputs, analogue output or digital communications, or any combination of these options.

Meters are programmed using front panel pushbuttons. The buttons may be locked with a rear switch.

Meters have two power supply options : 100-240 VAC or 11-30VDC

These meters are designed to mount into a protective enclosure which will protect users from contact with power and signal wiring.

These units must be installed fully assembled, and must be installed according to local electrical installation rules. When properly installed, they provide ingress protection to IP65 / NEMA4X from the front

## Safety



**Caution:** There is a risk of electrical shock if this instrument is not properly installed



**Caution:** Risk of danger: Read the whole manual before you install this meter

Obey all safety warnings in this manual, and install the meter according to local wiring and installation regulations. Failure to follow these guidelines may cause damage to the meter, connected equipment, or may be harmful to personnel.

Any moving mechanical device controlled by this equipment must have suitable access guards to prevent injury to personnel if the meter should fail.

# Mounting and Installation - Class II

Install the meters in a suitable protective electrical control enclosure according to local wiring regulations. See specifications for maximum allowable temperature in enclosure. Allow adequate air circulation.

**Installing into front of panel**  
Remove the two rear bracket screws and safely store them and the U-Bracket for later fitting.

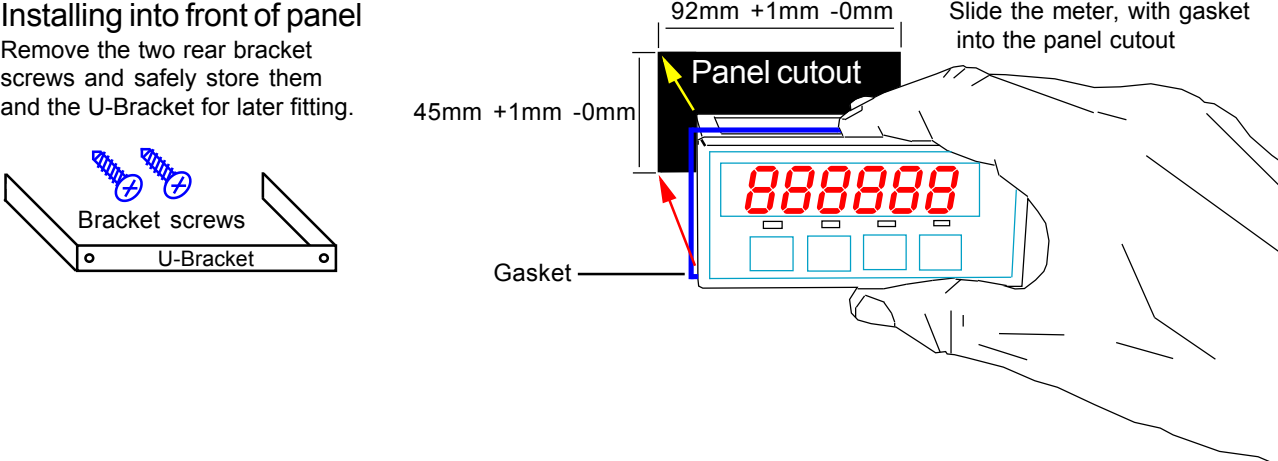

Slide the meter, with gasket into the panel cutout

92mm +1mm -0mm  
45mm +1mm -0mm  
Panel cutout  
Gasket  
Bracket screws  
U-Bracket

**Securing into the panel**  
Re-fit the U-Bracket and tighten the bracket screws to firmly clamp the meter in place. Check that the gasket is evenly pinched between the meter's front bezel and the enclosure front.

**Ventilation**  
There should be sufficient ventilation in the enclosure to ensure that the meter's case is always kept to less than 60C.

**Meter Spacing.**  
Meters should be spaced apart sufficiently to allow a free flow of ventilation air around the meters, such that no part of the case will exceed 60C

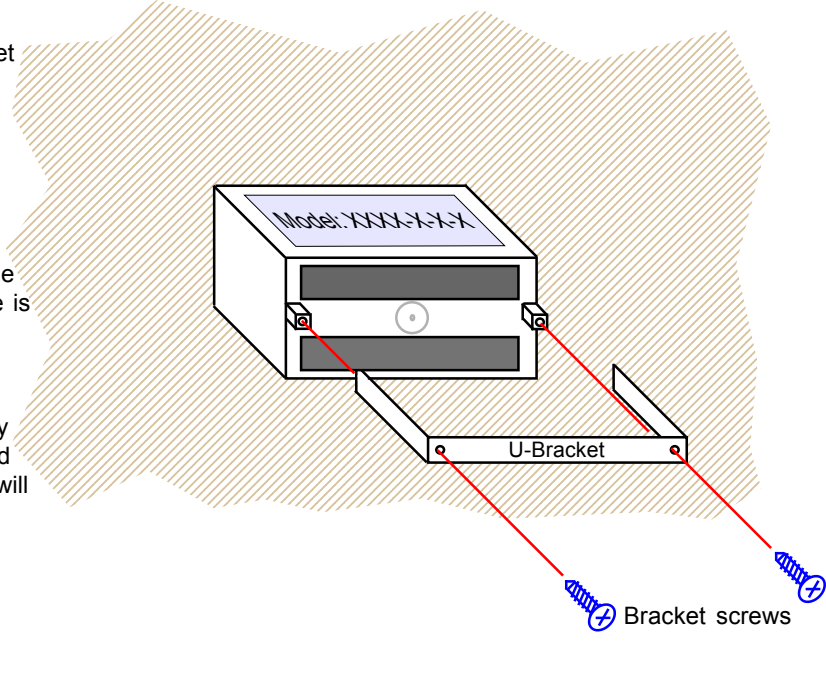

Model: XXXX-X-X-X  
U-Bracket  
Bracket screws

**Side view of meter installed in panel**

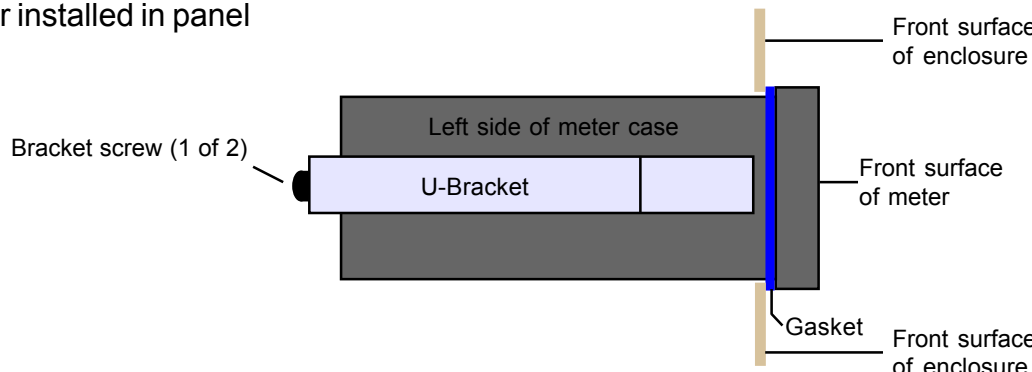

Bracket screw (1 of 2)  
Left side of meter case  
U-Bracket  
Front surface of enclosure  
Front surface of meter  
Gasket  
Front surface of enclosure

# Wiring Advice

This meter uses detachable screw terminal connectors. Refer to the wiring diagram on the following page for the correct positioning of each wire.

The conductors you use must be suitable for the meter's temperature, current and voltage rating, which is broadly described as follows:-

## Cable Temperature Rating

All cables must be rated for operation up to 90C continuous.

## Cable gauge and screw tightness

The connectors on this instrument can accept conductors up to 16 gauge AWG / 1.5mm<sup>2</sup> c.s.a. The minimum cross sectional area shall be 22 gauge AWG / 0.5mm<sup>2</sup>. Tighten screw terminals to 7.0 lb/in torque / 0.8 Nm torque.

## Cable insulation voltage rating

Cables shall have an insulation voltage rating of at least 380V continuous.

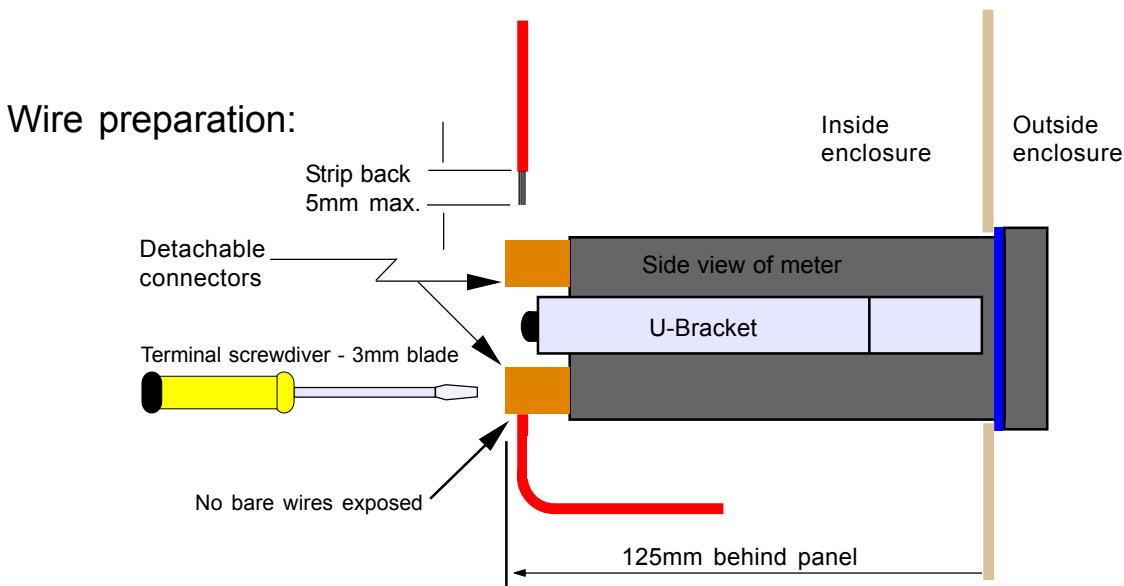

We recommend multi-strand wire, because it withstands vibration better than single strand cable. Pull the wire firmly after you make the connection to confirm it is tight.

Use screened cable for all signal and control wiring and connect the screen to earth at the destination end only. Route signal cabling away from power cabling and relay switching cabling, to avoid electrical noise interference.

# Connections

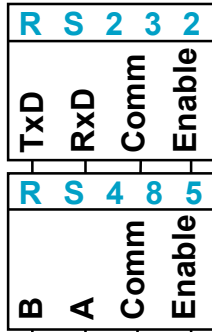

**Enable** is used in mode C1 to activate or de-activate the RS232 or RS485 serial output. Connect to Comm to continually transmit data.

**Connectors and options**  
Connectors may be present even if output options are not installed. Refer to rating label to see installed options.

Rated 2A 250VAC Resistive  
**AL1 AL2 AL3 AL4**

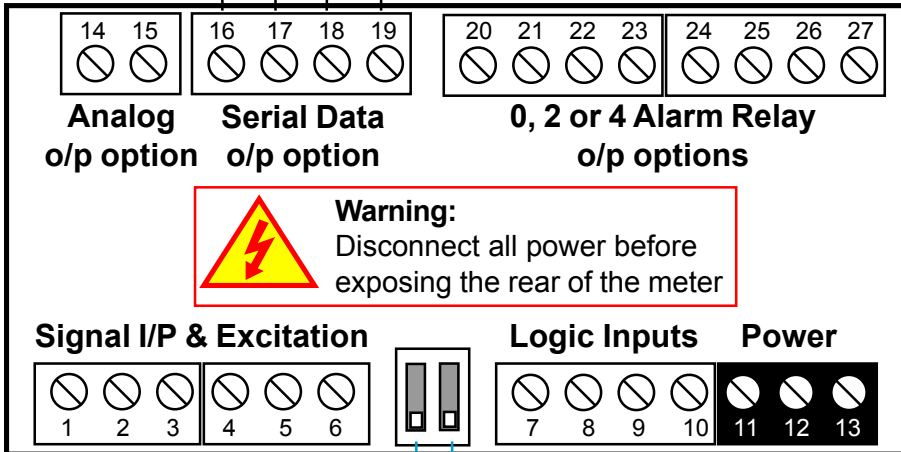

**Warning:**  
Disconnect all power before exposing the rear of the meter

**Class II Installation**

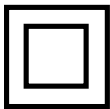

Customer-supplied disconnection and overload protection devices

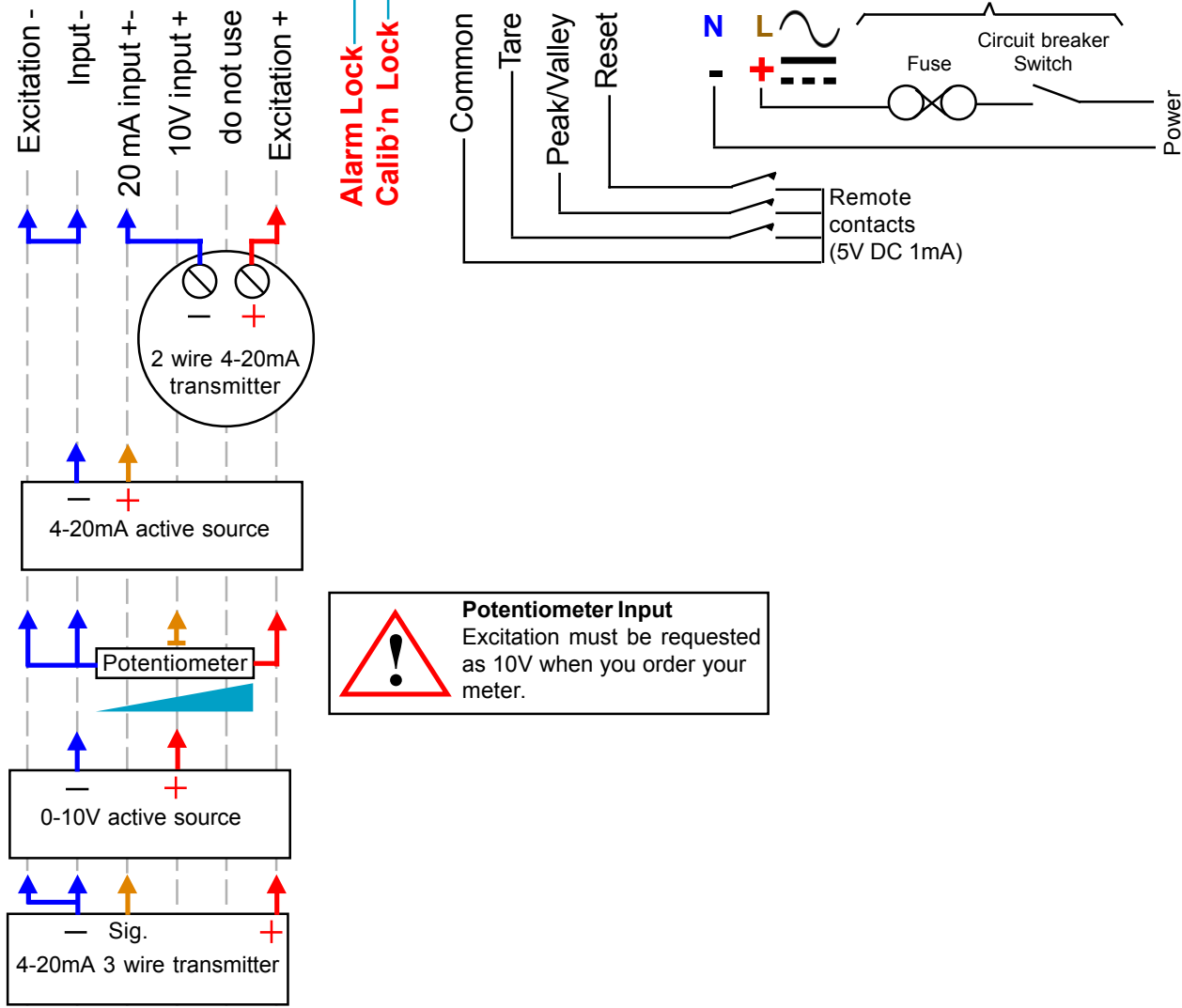

**Potentiometer Input**  
Excitation must be requested as 10V when you order your meter.

# Startup meter Settings

**Lockout notes:** Cal Lock switch = OFF when changing. Switch Cal Lock to ON after changing

## Menu Language Choice

Press the two right hand buttons briefly. You will see the **User Interface language**, which you can change with the UP or DOWN buttons. Accept with OK

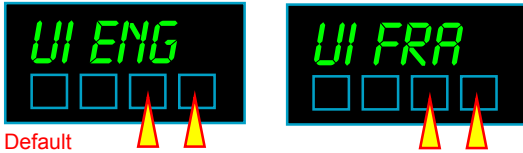

Next you will see ...

---

## Meter Bootup routine



1. Activates all digit segments
2. Runs up and down brightness settings
3. Displays model number and installed options
4. Displays firmware version
5. Displays calibration audit number.
6. Goes to meter mode



1. Activates all digit segments
2. Runs up and down brightness settings
3. Displays model number and installed options
4. Goes to meter mode



1. Goes immediately to meter mode

When you switch the meter on, it can run through a summary list of software version number, installed options, calibration number etc.

You can choose from the 3 lists of bootup information to be displayed, the less information you display, the sooner the meter will be available to operate.

Next you will see ...

---

## Tare Memory



You can configure the meter to store any tared values on power down (Tare S), typical in weighing applications, or you can clear the tare memory on power down (Tare N).

Next you will see ...

## Drift cancellation

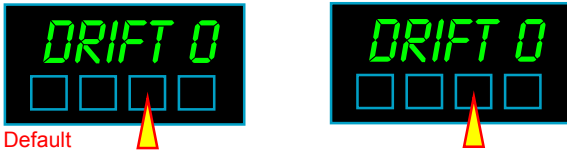

If your meter will normally be showing 0, for example a platform scale, you can set the meter to continually cancel any long term drift. To do this, set Drift 1.

This only operates at and around zero reading.

The meter will compare readings to previous ones every 30 seconds, and if the value has changed by a small amount, the meter will automatically re-zero. The maximum movement in a 30 second period is 8 counts of the least-significant digit. Any more than that, we assume the change has been a valid process movement, so leave the change unaltered.

## Brightness Adjustment

**Lockout notes:** Cal Lock switch = ON when changing.

In normal operation, you can select from one of 8 brightness levels, to suit your local lighting conditions, or to match the brightness of several meters which may be from different batches or ages.



Press for 3 seconds, then press the down or up button to decrease or increase the brightness.

Press OK when set.

Your chosen brightness level will be saved in memory, so that the meter will return to the chosen brightness after power-off.

## Factory Default Settings

**Lockout notes:** Cal Lock switch = OFF when changing.

You can reset your meter to return it to its original factory default settings. (Shown as **Default**)



Switch the lockout switch off and press all 4 buttons for around 3 seconds.





Then press the up or down button to change to "dEFS Y"

Press OK to accept.



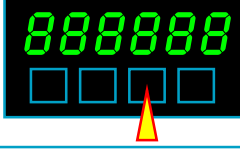
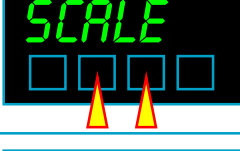



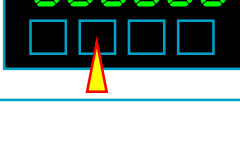

**Warning:** You will clear ALL settings when you choose dEFS Y

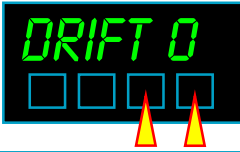
# Button Functions- 'Quick-Step' - Page 1

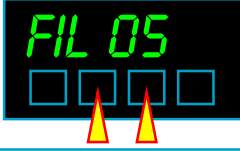
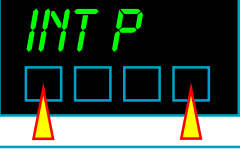
Functions	Buttons	Conditions
<b>Alarm Settings</b> Press button briefly to view >3 seconds to change setpoint >5 seconds to change function		Can be viewed at any time. Alarm lockout OFF to change
<b>Analogue Output Settings</b> Press > 3 seconds to enter		Calibration lockout OFF
<b>Brightness</b> Press button for 3 seconds Change with UP/DOWN button. OK=Accept		Calibration lockout ON
<b>Calibration Scale Factor</b> Press both buttons >3 secs, press OK 2x Change with UP/DOWN button. OK=Accept		Calibration lockout OFF
<b>Calibration Offset</b> Press both buttons >3 secs, press OK 3x Change with UP/DOWN button. OK=Accept		Calibration lockout OFF
<b>Calibration Span Setting</b> Press > 3 seconds to enter		Calibration lockout OFF
<b>Calibration Type</b> Press both buttons >3 secs Change with UP/DOWN button. OK=Accept		Calibration lockout OFF
<b>Calibration Zero Setting</b> Press > 3 seconds to enter		Calibration lockout OFF
<b>Decimal Point position</b> Press button 3 seconds, set during Cal Span Change with UP/DOWN button. OK=Accept		Calibration lockout OFF

## Button Functions- 'Quick-Step' - Page 2

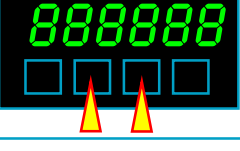
Functions	Buttons	Conditions
<p><b>Drift Compensation</b></p> <p>Press both buttons briefly, press OK 2x Change with UP/DOWN button. OK=Accept</p>		Calibration lockout OFF
<p><b>Filter Jump percentage</b></p> <p>Press both buttons &gt;3 secs, press OK 1x Change with UP/DOWN button. OK=Accept</p>		Calibration lockout OFF
<p><b>Filter time constant</b></p> <p>Press both buttons &gt;3 secs Change with UP/DOWN button. OK=Accept</p>		Calibration lockout OFF
<p><b>Hardware &amp; Software summary</b></p> <p>Press both buttons &gt;3 secs</p>		Can be viewed at any time
<p><b>Language&amp; Boot-up mode</b></p> <p>Press both buttons briefly Change with UP/DOWN button. OK=Accept</p>		Calibration lockout OFF
<p><b>Last digit round-up</b></p> <p>Press both buttons &gt;3 secs, press OK once Change with UP/DOWN button. OK=Accept</p>		Calibration lockout OFF
<p><b>Linearisation</b></p> <p>Press both buttons briefly, press Change with UP/DOWN button. OK=Accept</p>		Calibration lockout OFF
<p><b>Menu timeout delay</b></p> <p>Press both buttons briefly, press OK 3x Change with UP/DOWN button. OK=Accept</p>		Calibration lockout OFF
<p><b>Reset Peak &amp; Valley memories</b></p> <p>Press min/max briefly then reset for 3 sec.</p>		Calibration lockout ON Link terminals 7, 9 and 10

# Button Functions- 'Quick-Step' - Page 3

## Functions

## Buttons Conditions

### Reset Tare

Press buttons briefly

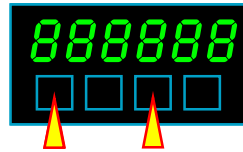

Calibration lockout ON  
Link terminals 7, 10 and 8

### Reverse / Mirror display

Press both buttons briefly, press OK 5x  
Change with UP/DOWN button. OK=Accept



Calibration lockout OFF

### Serial Comms setup

Press both buttons briefly

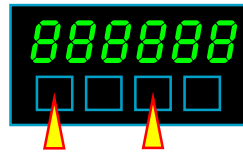

Calibration lockout OFF

### Tare display to 0

Press button briefly. Display shows 0 and the  
button LED will illuminate to show you are tared.

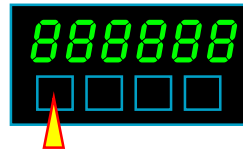

Calibration lockout ON and  
Link terminals 7 and 8

### Tare Storage

Press both buttons briefly, press OK once  
Change with UP/DOWN button. OK=Accept



Calibration lockout OFF

### Valley & Peak (Max. & Min.)

Press button briefly, once for peak, next for  
valley.



Calibration lockout ON  
Link terminals 7 and 9

# Filter settings

You can use the filter to improve display stability. This is useful if your signal is unstable. Bigger time constants give more stability but slower response.

## Filter time constant

Press both buttons >3 secs

Change with UP/DOWN button. OK=Accept

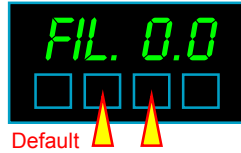

Calibration lockout OFF

The Time constant of this digital filter is very similar to the time constant of an RC filter where  $T=RC$ . The time constant is the time it takes for the display to reach 63 % of its final reading value, after a step change on the input.

You will see that if you select a 1 second filter time, it will take several seconds for the meter to reach its final value.

To give improved response to large step changes, we can momentarily cancel the filter action with the 'Filter Jump' feature

## Filter Jump percentage

Press both buttons >3 secs, press OK 1x

Change with UP/DOWN button. OK=Accept

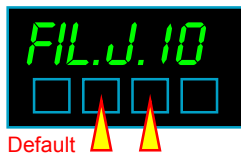

Calibration lockout OFF

How does the Filter Jump feature work?

First, make a note of the range you **calibrated** your meter over (not the full dynamic range of the meter, just the difference between the maximum and minimum display values you set, in either direct or theoretical calibration) Let's assume you calibrated the meter for a 250 range.

If you set the filter jump percentage to 25%, any sudden change in input of less than 25% of 250 will be included in the averaging calculation.

However, a jump of greater than 25% will cause the filter to be ignored and the meter will immediately jump to that new value.

If you set a jump of 0%, filtering will always be overridden (never any filtering)

If you set a jump of 99%, filtering will always be present, so long as the input signal doesn't jump more than 99% of the calibrated range.

# Calibration Methods - introduction

There are two ways you can calibrate your display, and each way can be done with 2 points only, or up to 10 linearisation points.

- A. Direct connection of real-time low and high input signal levels, which you scale the display against. (Zero and Span)
- B. Theoretical scaling, where you use the keyboard to enter expected zero and full scale sensor signals, and the measurement amounts these relate to .

Calibration lockout switch must be OFF to view and/or change calibration.  
Press **Set1** and **Set2** buttons at the same time...

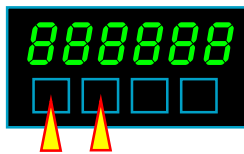

After a couple of seconds, display shows...

Shortly after CAL.SrC appears, the display will change to show either **dirECT** or **tHEOR** as below.

## Examples of Direct Calibration...

1. If you want to calibrate a weighing system by loading it with known calibration weights.
2. If you want to calibrate a straight-sided tank gauging system by filling the tank with a known amount of liquid.
3. If you are performing a calibration check against a calibration reference, such as humidity cells, pH buffers etc.

Press UP or DOWN arrow to change



Press OK to choose.

## Examples of Theoretical Calibration...

1. If you do not yet have your sensor, but know what its published calibration settings are. For example, you plan to use a pressure sensor, which will give 4-20mA for 0-250 Bar. You can enter the input range of 4-20mA and the measurement range of 0-250.
2. If you are a distributor, supplying a transmitter to an end user who will be buying his sensor from another source. He has told you on his order what he would like the scaling to be.

Press UP or DOWN arrow to change

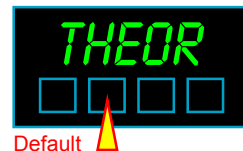

Press OK to choose.



When you have chosen the Calibration type, it will be saved in your display's memory, so you will not need to repeat the procedure.

You may now calibrate your display using your preferred method, on the following pages...

# Direct Calibration, no linearisation

**Lockout notes:** Cal Lock switch = OFF when changing. Switch Cal Lock to ON after changing

Set your calibration method to DIRECT - see previous page.

Assume we want to calibrate a weighing platform, rated at 250kg. We have a 200kg calibration weight. (Use at least 60% rated load for calibration. 100% ideally)

First, calibrate the full scale (SPAN) reading. We do SPAN first, because in the SPAN procedure we can set the **decimal point** position of our measurement, to set resolution.

**SPAN Calibration** . Apply your calibration load and press the **Set2** button for 3 seconds. Display will show 'direct' , 'set HI' . Press OK. You will see that one digit is brighter than the others.

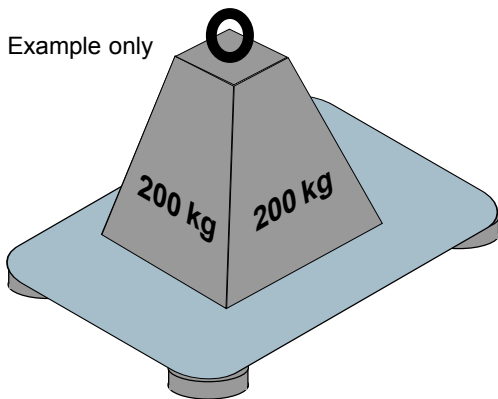

Enter your calibration weight value.

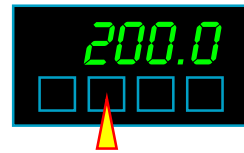

Press OK when done.

You can edit the value of a brightened digit with the UP/DOWN buttons. You can brighten other digits with the DIGIT button.

Go through each digit in turn, to set the desired value of your calibration load. Press OK when done.

To set the **decimal point position**, press the **Set2** button for 3 seconds whilst in the numeric setting stage . You'll see all decimal points light, with one brighter than the rest. Use UP or DOWN buttons to move the brightest decimal point and press OK when in the desired position.

**ZERO Calibration.** Remove your load and press the **Set1** button for 3 seconds. Display will show 'direct' , 'set LO' . Press OK. You will see that one digit is brighter than the others.

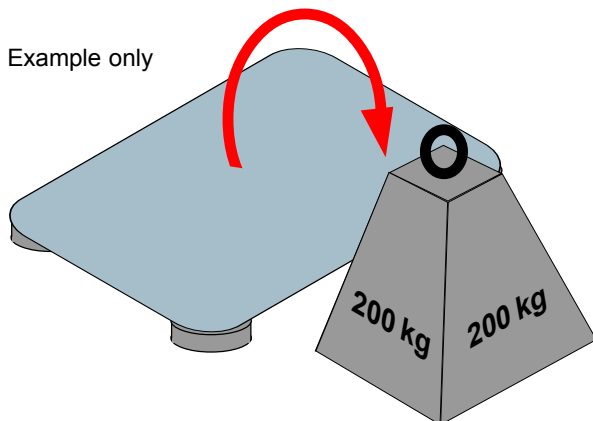

You can edit the value of a brightened digit with the UP/DOWN buttons. You can brighten other digits with the DIGIT button. Go through each digit in turn, to set all digits to 0. Press OK when done.

# Theoretical Cal., no linearisation - page 1

**Lockout notes:** Cal Lock switch = OFF when changing. Switch Cal Lock to ON after changing

Set your calibration method to THEORETICAL - see previous pages

As an example, let us assume we want to calibrate the display for a loadcell input.

Let us also assume that we know from the calibration sheet which came with the loadcell, that it has a sensitivity of 0 to 2.2451mV/V and a rated capacity of 0 to 5000kg

The Display generates 10 V of excitation for the loadcell. So we can simply multiply the mV/V figure by 10 to get our full scale mV value.

Most loadcells are balanced to give 0mV at 0 load.

This means that for a load range of 0 to 5000 kg we expect a signal range of 0 to 22.451mV

We need to enter these figures into the transmitter...

**Start with the full scale SPAN setting...**

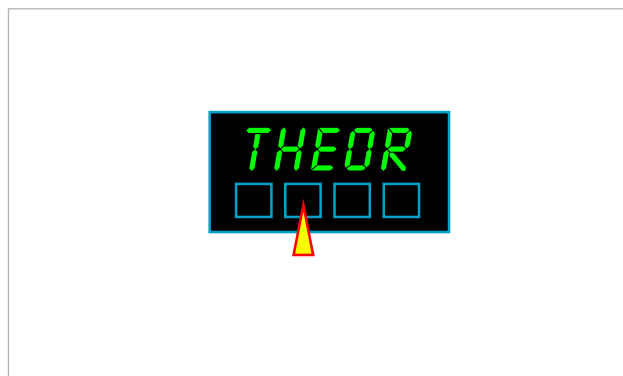

Press the **Set2** button for around 3 seconds.

The display will briefly show **theor**, to confirm that we are in the theoretical setup mode.

Choose with the up or down arrows and press OK.



In HI will appear briefly, followed by a numeric value, which you can set...

The numeric value will need to be the High input signal level ...



Set to highest input signal level which was 22.451mV, according to the sensor calibration sheet in our example.

You can change the value of the brightest digit with the UP or DOWN buttons. Brighten other digits with the DIGIT button.

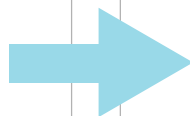

Press OK when done...

# Theoretical cal., no linearisation - page 2

...Continued from previous page

**rd HI** will appear briefly, followed by a numeric value, which you can set...

The numeric value will need to be the High display reading value ...



Set to highest reading value, which was 5000 according to the sensor calibration sheet in our example.

You can change the value of the brightest digit with the UP or DOWN buttons. Brighten other digits with the DIGIT button. Press OK when done...

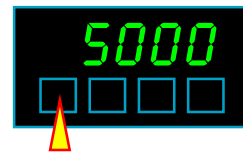

To change decimal point position, press the **Set2** button for around 3 seconds while you're in the rdHI setup...



You can change the position of the decimal point, relating to rd HI (and rd LO)

This may be useful if you want to increase the resolution of the display.

The resolution affects several of the display's important functions, such as ...

- ...the resolution of the analogue output signal
- ...the resolution of your alarm relay action.
- ...the resolution of the serial data output value.

As an example, assume you have a sensor with 10 tonne capacity.

If you scale the display for 0 to 10, the resolution will only be 1 part in 10

Your analogue output will change in 10% steps. Your precision of alarm setting would be to within 1 tonne.

The resolution of serial data would be within 1 tonne.

However, if you include a decimal point you could control the resolution, as in these examples :-

- 0-10.0 which gives 1% resolution
- 0-10.00 which gives 0.1% resolution
- 0-10.000 which gives 0.01% resolution

You cannot get more resolution than 1 part in 60000. This is the limit of resolution in the A/D converter.

**Note:** If you change the decimal point position, you must reset the rdLO and rdHI values also.

Next .... how to set the theoretical ZERO calibration...

Use the UP arrow button to move the decimal point to your desired position.

Press OK when done.



# Theoretical cal., no linearisation - page 3

Continued from previous pages. ZERO setting ...

Press the **Set1** button for around 3 seconds.

**theor** will appear briefly, to confirm that you are in the theoretical calibration mode.

The numeric value will need to be the low input signal value ...



Next, **In Lo** will appear briefly. Set to the low input value, which was 0mV according to the sensor calibration sheet in our example.

You can change the value of the brightest digit with the UP or DOWN buttons. Brighten other digits with the DIGIT button.

Press OK when done...

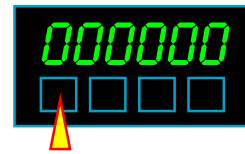

**rd LO** will now appear briefly, followed by a numeric value, which you can set...

The numeric value will need to be the low reading value ...



Set to the low reading value, which was 0kg according to the sensor calibration sheet in our example.

You can change the value of the brightest digit with the UP or DOWN buttons. Brighten other digits with the DIGIT button.

Press OK when done...



This completes the Theoretical calibration routine. Please remember to switch the Calibration Lockout switch ON

# Linearisation - theoretical scaling

**Lockout notes:** Cal Lock switch = OFF when changing. Switch Cal Lock to ON after changing

Choose THEORETICAL Calibration method - See the Calibration methods page.



Default

Press both left buttons briefly  
You can now choose to have the  
lineariser on or off



Press OK to select



Confirms you are in  
Theoretical Cal mode

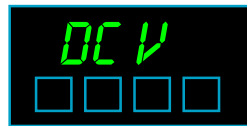

Confirms DC voltage  
range.  
If DC current, this display  
will show DC A

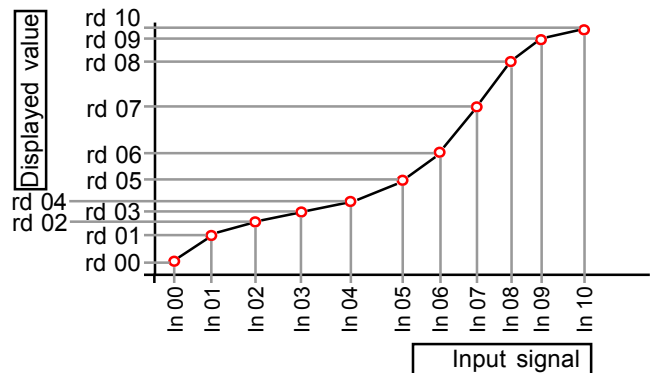

**IMPORTANT : In0 < In1 ..... In9 < In10**

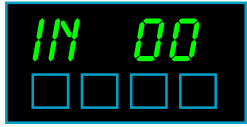

Set Value for input  
signal at point 0.  
Press OK when  
done



Set Value for  
display at point 0.  
Press OK when  
done

Press OK if you want  
to add another point

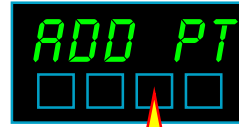

Press OK if you want  
to quit / abort.



Press OK if you want  
to finish and save.



Press OK to select

You can set as many or few points  
as you wish. 11 points available.



Set Value for input  
signal at point 10.  
Press OK when  
done



Set Value for  
display at point 10.  
Press OK when  
done

Press OK if you want  
to quit / abort.

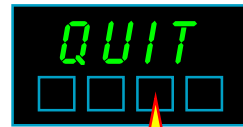

Press OK if you want  
to finish and save.



Press OK to select

# Linearisation - Direct scaling

**Lockout notes:** Cal Lock switch = OFF when changing. Switch Cal Lock to ON after changing

Choose a DIRECT Calibration method - See the Calibration methods page.



Default

Press both left buttons briefly  
You can now choose to have the  
lineariser on or off

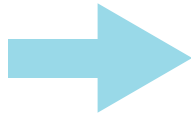

Default



Press OK to select



Confirms you are in  
Direct Cal mode

Apply several  
known loads  
and tell the  
meter what  
it should read

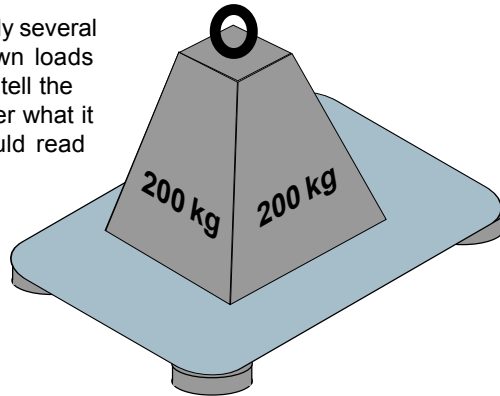

Confirms DC voltage  
range.  
If DC current, this display  
will show DC A



Apply input for  
known value 00.  
Press OK when  
done

Press OK if you want  
to add another point

Press OK if you want  
to quit / abort.

Press OK if you want  
to finish and save.



Set Value for  
display at point 0.  
Press OK when  
done

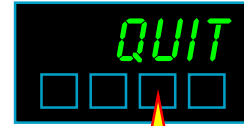
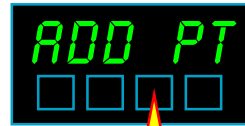

Press OK to select

You can set as many or few points  
as you wish. 11 points available.  
You can quit and Save with less than  
11 points if you wish.

**IMPORTANT : Set0 < Set1 ..... Set9 < Set10**

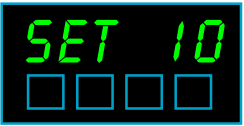

Apply input for  
known value 10.  
Press OK when  
done

Press OK if you want  
to quit / abort.

Press OK if you want  
to finish and save.



Set Value for  
display at point 10.  
Press OK when  
done

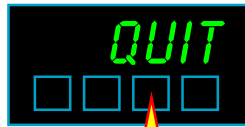

Press OK to select

# Zero Drift Compensation

**Lockout notes:** Cal Lock switch = OFF when changing. Switch Cal Lock to ON after changing

If your application means the display is normally showing 0, for example a weighing platform which only occasionally carries a load, you can set the meter to constantly check the zero calibration.

It does this by comparing readings every 30 seconds, and if the reading should wander off 0 by a small amount, the meter will re-zero the display.

It will not re-zero if the reading goes above 8 counts, or below -8 counts, as we consider that this may be a true measurement value.

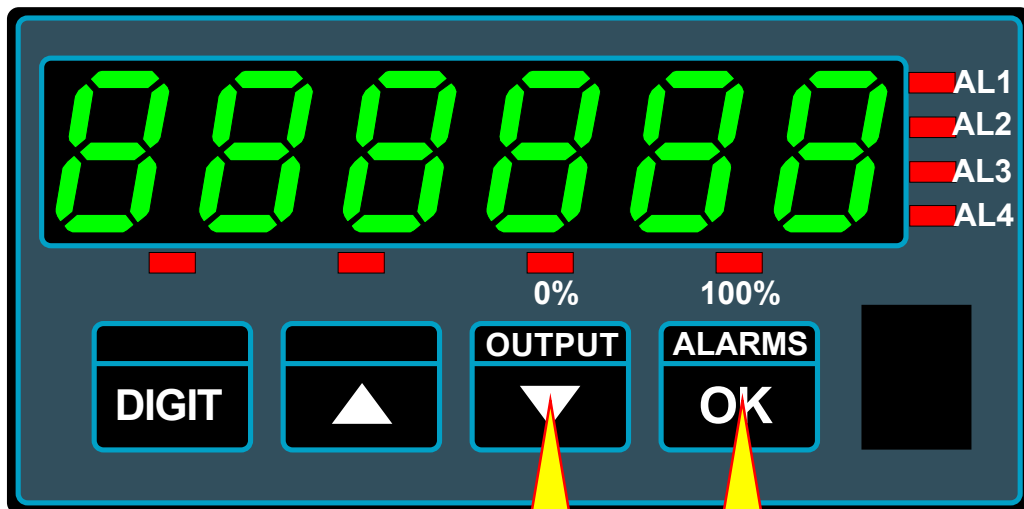

Press together briefly (will show "UI ENG")

Now press 2 times until you see something like ...

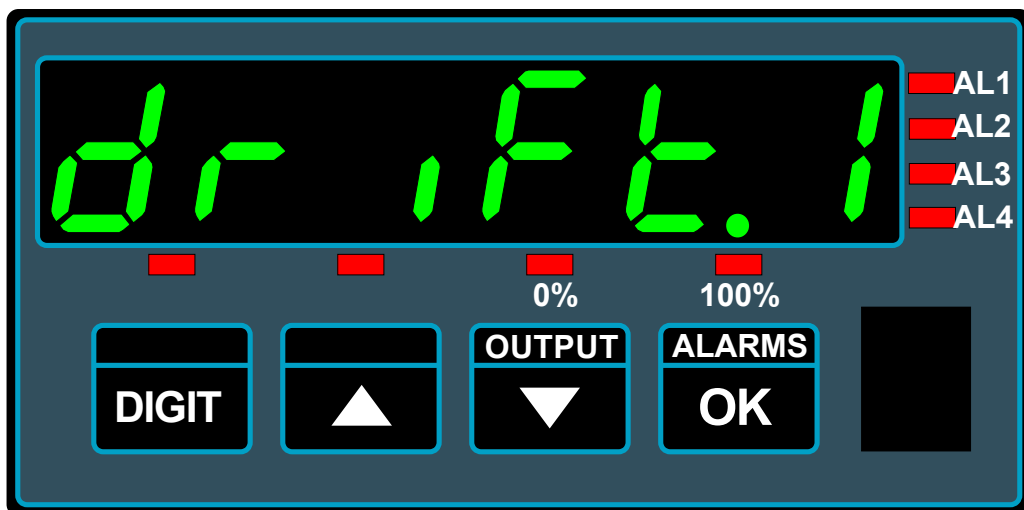

Use the UP/DOWN buttons to choose **drift.0** to disable the drift correction or **drift.1** to enable it. Press OK when done.

# Post Calibration Scale and Offset

After you have calibrated your meter to your sensor, you may later want to trim the reading or convert it to different units of measure, for example from kg to pounds or Nm, from Degrees C to Degrees F etc., without going through the whole calibration procedure again.

You can do this with the SCALE and OFFSET functions, which are normally set to 1.0000 and 0.0000 respectively.

New display = (Existing display x **Scale**) + **Offset**



Default = 001.000



Default = 0000.00

Calibration lockout OFF  
Press both middle buttons >3 seconds.  
Repeatedly press OK until Scale or Offset appears.

## Examples.

### 1. Correcting for gravitational variance

Your weighing system was calibrated where gravitational acceleration =  $9.812\text{m/s}^2$  (London)  
You then move the system to Bangkok where gravitational acceleration is reduced to  $9.782\text{m/s}^2$

You can correct for this difference by setting Scale =  $9.812 / 9.782 = 1.0031$ , so that a given mass in Bangkok will show the same weight as it did in London.

Set Offset = 0.0000

See [http://en.wikipedia.org/wiki/Earth%27s\\_gravity](http://en.wikipedia.org/wiki/Earth%27s_gravity)

### 2. Converting from DegC to Deg F

Your system was calibrated to show Deg C but you want to change it to Deg F without altering the calibration.

Set Scale = 1.8000 and Offset = +32.0000

### 3. Converting from DegF to Deg C

Your system was calibrated to show Deg F but you want to change it to Deg C without altering the calibration.

Set Scale = 0.5556 and Offset = -32.0000

### 4. Converting from kg to Pounds

Your system was calibrated to show kg but you want to change it to Pounds without altering the calibration.

Set Scale = 2.205 and Offset = 0.0000

# How to install option boards



Where the product is intended for “UL” installations removal or addition of option boards is not permitted.



**Warning:** Disconnect all power before exposing the rear of the meter

If you want to open your meter to install or modify option boards, follow these steps...

- 1) Switch off power to the meter and unplug all connectors.
- 2) Unclip the front bezel. This is easier if you squeeze the top and bottom of the case, near the front.
- 3) Remove the small screws shown in the diagram. If the meter doesn't yet have an output option board, the top screw may not yet be fitted.
- 4) Slide the electronic boards out through the front of the case. You can easily separate the upper option board from the main board. We strongly suggest that you use anti-static precautions to prevent damage to the semiconductors.

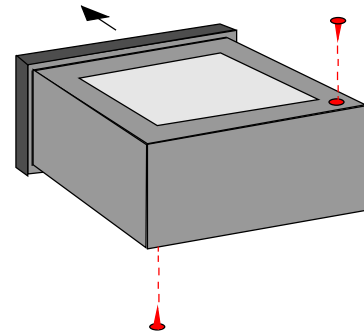

The board assemblies will look something like this...

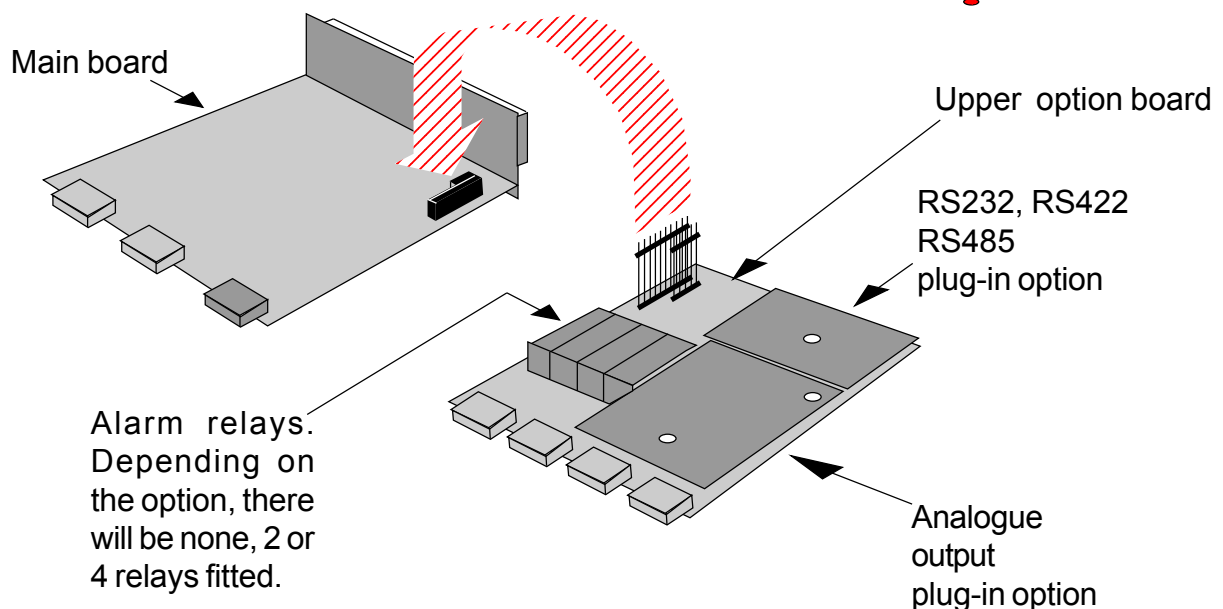

The analogue output and RS232 or RS422 plug-in option boards are fixed to the upper option board with white plastic pillars. You must apply a firm force when fitting or removing these options.

Always be careful to connect the pins to sockets accurately. When reassembling, make sure option boards are firmly fixed to the upper option board. When the boards are replaced in the case, secure them again with the two small black screws.

# Analogue Output - page 1



Where the product is intended for “UL” installations removal or addition of option boards is not permitted.



**Warning:** Disconnect all power before exposing the rear of the meter

The analogue output board plugs onto the 0, 2 or 4 alarm upper option board.

It plugs onto a pair of connectors and is secured by two snap-pillars.

Check that the unit is set for voltage or current output, to suit your application.



**Warning:**  
Disconnect all cables from option board before adjusting

Current  
0-20mA & 4-20mA



Voltage  
0-10V

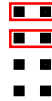

NOTE: If you have the bipolar -10 to +10V output analogue option (ANB) there are no configuration jumpers.

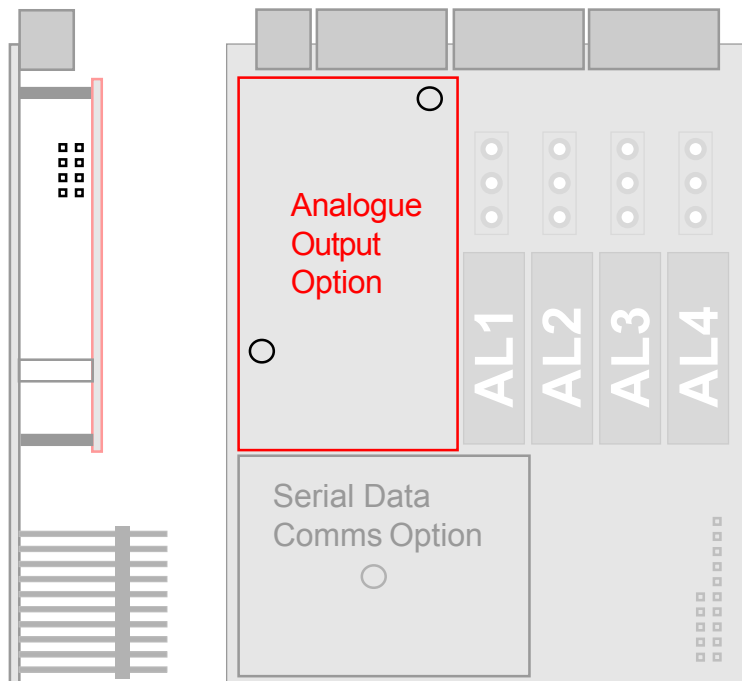

Re-assemble the meter, apply power and follow the Analogue Output Settings procedure on the next page.

You can set the analogue output to operate over a display range of your choice, to create 0-20mA, 4-20mA or 0-10V, or, with the ANB version, -10V to +10V, fully isolated.

Default=4-20mA

Please see the following page for a guide how to do this.

## Handy Feature

You can tell if an analogue output is fitted to your meter, and if it has been set for voltage or current, by viewing the ‘Summary’ display.

To see this, press the two outer buttons of the display for 3 seconds. You will also see the summary when you first switch on your meter.

## Analogue Output - page 2

**Lockout notes:** Cal Lock switch = OFF when changing. Switch Cal Lock to ON after changing

Your analogue output can cover 0-100% of its range over a display range which you can set.

For example, you might want 4-20mA output, for a display range of 500 to 1000.

You would press the Analogue O/P button for 3 seconds, and select 4-20mA

Then set 0% = 500

Then set 100% = 1000

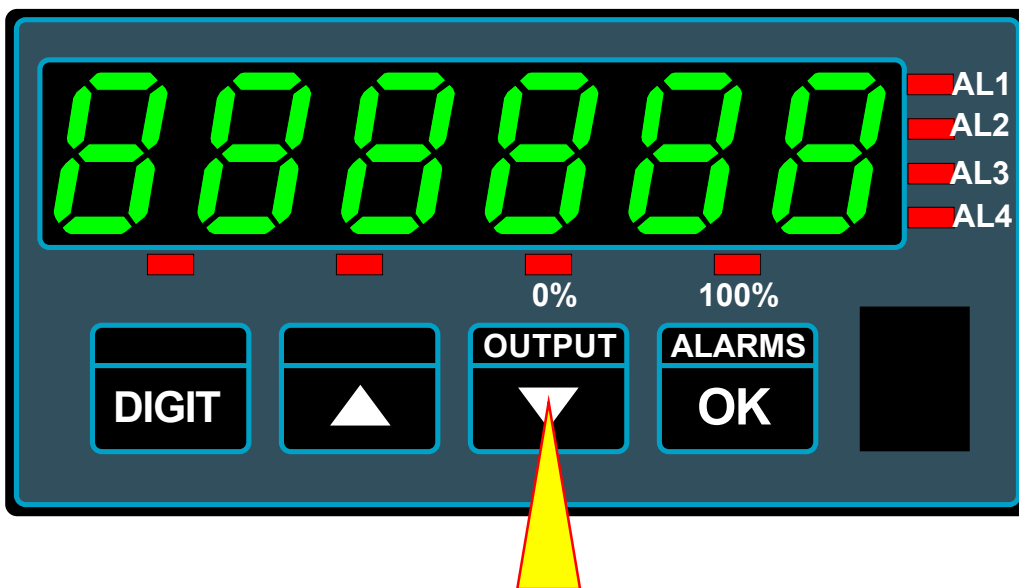

Press the OUTPUT button for 3 seconds. If an output board is fitted, the display will confirm this and confirm the range chosen by the jumpers on the previous page.

### Zero Setting

The 0% LED will flash. Select the Output range you want. Then select **net** or **gross**.

Use the **DIGIT**, ▲ and ▼ buttons to set the display value at which you want 0% analogue output.

Press **OK** when done. **Default = 4-20mA, Net, 0000.00**

### Span Setting

The 100% LED will flash.

Use the **DIGIT**, ▲ and ▼ buttons to set the display value at which you want 100% analogue output.

Press **OK** when done. **Default = 0100.00**

When you have finished setting the meter, put the lockout switch in its ON position now, to prevent your settings from being changed.

# Alarm Board Configuration



Where the product is intended for “UL” installations removal or addition of option boards is not permitted.



**Warning:** Disconnect all power before exposing the rear of the meter

You can have 3 types of alarm board:-

- An alarm board with no relays, which will simply allow you to fit analogue and/or serial output options.
- An alarm board with 2 relays, to which you can also fit analogue and/or serial output options.
- An alarm board with 4 relays, to which you can also fit analogue and/or serial output options.

For failsafe operation (where contacts open on alarm or when power is lost to the meter) set the jumpers for OPEN CONTACTS as shown below, and DE-ENERGISE on alarm, in the alarm setup menu. To access the alarm board, remove power from meter, including any power which might be on the alarm output board.

Look on the top and bottom surfaces of the case, near the rear. You will see two small screws, one on each surface. Remove both screws. Now, clip off the front bezel and slide the meter assembly carefully out via the front of the case. The relay board plugs into the main board. Gently separate the two boards.

 **Warning:** Disconnect all cables from option board before adjusting

 **Warning:** All switched power must come from the same phase.

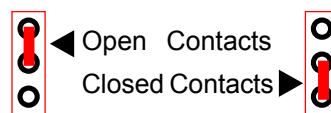
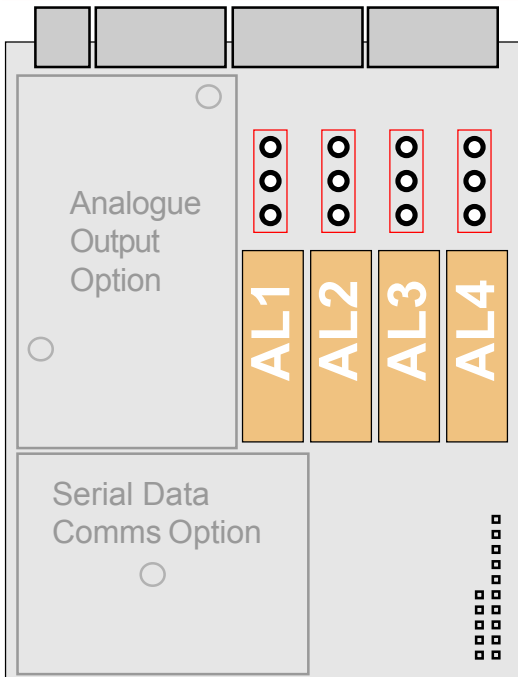

Default

Select relay output contact status, when relays are de-energised (power removed from meter) by placing these jumpers. Each relay has a snubbing network to minimise contact sparking.

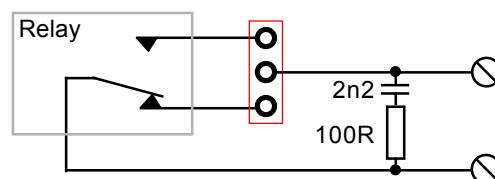

When you have set the jumpers, refit the board to the meter and carefully slide the assembly back into the case.

Fit the two small screws to the top and bottom surfaces of the case.

# Alarm Programming

**Lockout notes:** Alarm Lock switch = OFF when changing. Switch Alarm Lock to ON after changing

Alarm lockout switch must be OFF. Press alarm button briefly to choose an alarm channel - The AL1, AL2, AL3 or AL4 leds tell you which channel is selected.

Press the alarm button for 3 seconds to show the Setpoint window - you can now edit the setpoint value with the DIGIT, UP and DOWN buttons. Press OK when done.



▲ 3 seconds, change setpoint only



▲ 6 seconds, change alarm function and setpoint, or only 3 seconds if the alarm is currently set OFF

If you want to change the function of an alarm channel, keep your finger on the alarm button for a further 3 seconds after you see the Set.pt prompt, which will bring up the AL CFG (alarm configure) prompt.



Inactive **Default**

High Alarm

Low Alarm

In-flight, high alarm

In-flight, low alarm - manual

In-flight, high alarm - automatic

In-flight, low alarm - automatic

In band alarm

Out band alarm

Choose whether the alarm will operate on Gross or Nett value.



**Default**

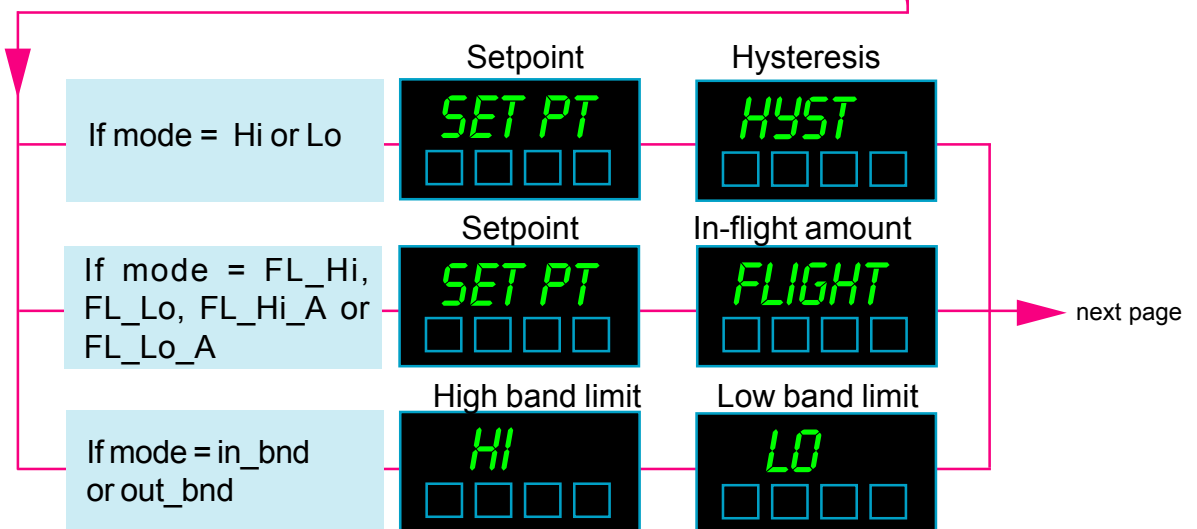

# Alarm Programming

From previous page

Relay coil state during alarm.

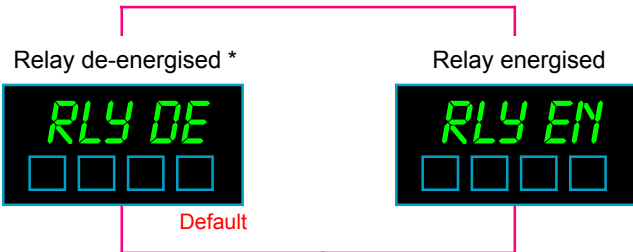

\* Use rLY dE for failsafe applications. This will cause the alarm contacts to go into alarm status if power is lost to the meter.

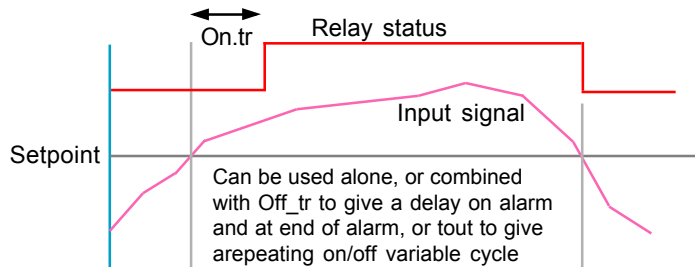
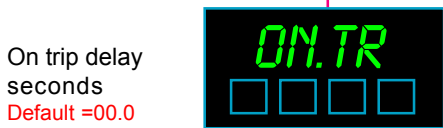

Example of a HIGH alarm relay, with delayed trip action

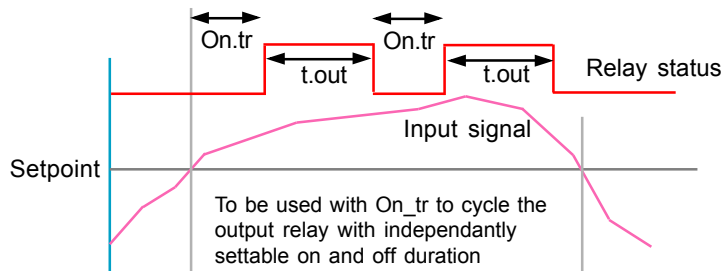

Example of a HIGH alarm relay, with cyclic trip action

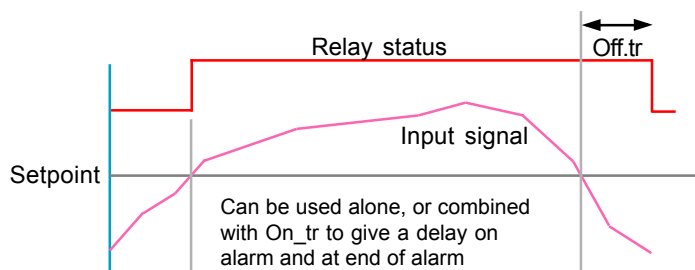

Example of a HIGH alarm relay, with delayed trip reset

End

See the alarm board configuration page also, for details on selecting normally open or normally closed contact outputs.

See the following pages for more detailed descriptions of how each alarm mode operates. Remember to put the alarm lock switch ON when finished, to keep your settings safe.

# Hi Alarm relay action, no Hysteresis

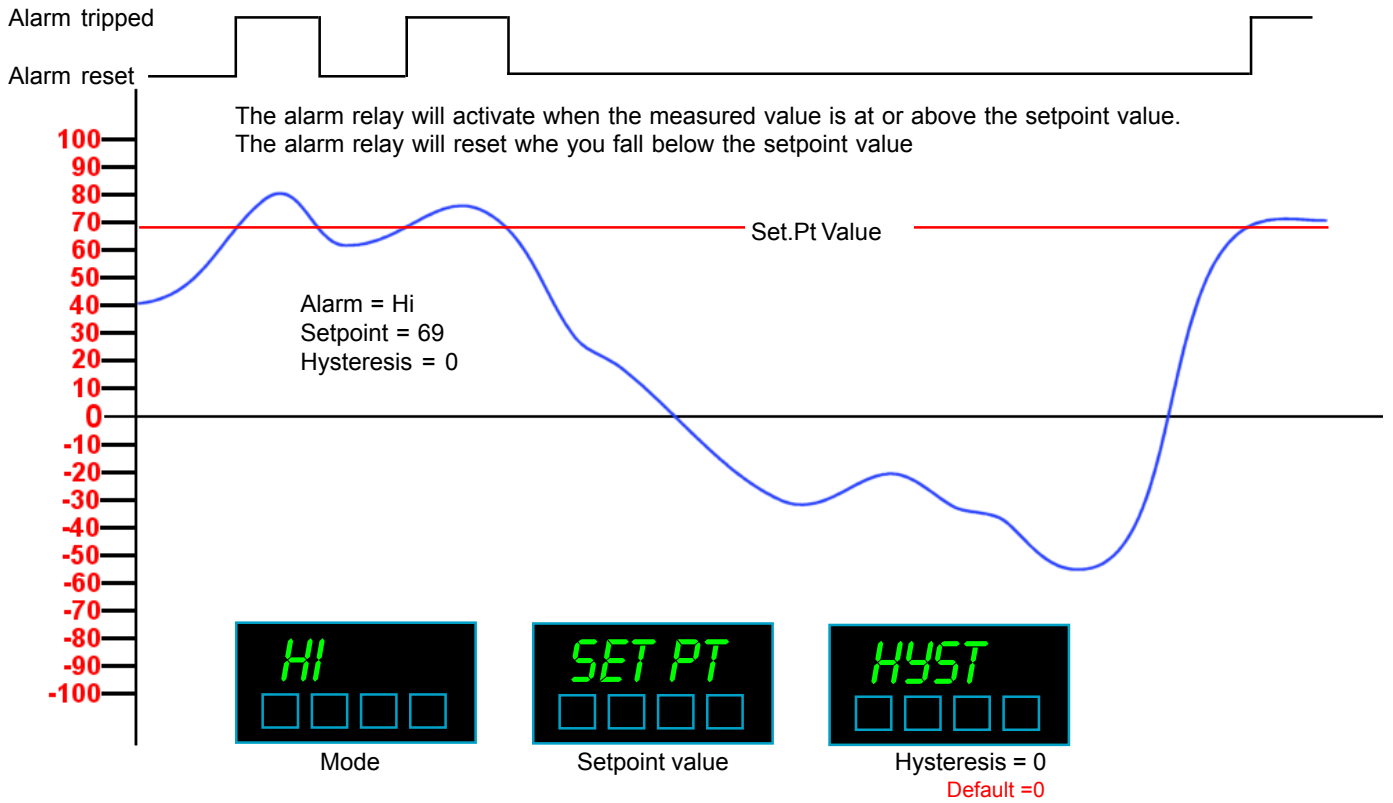

# Hi Alarm relay action with Hysteresis

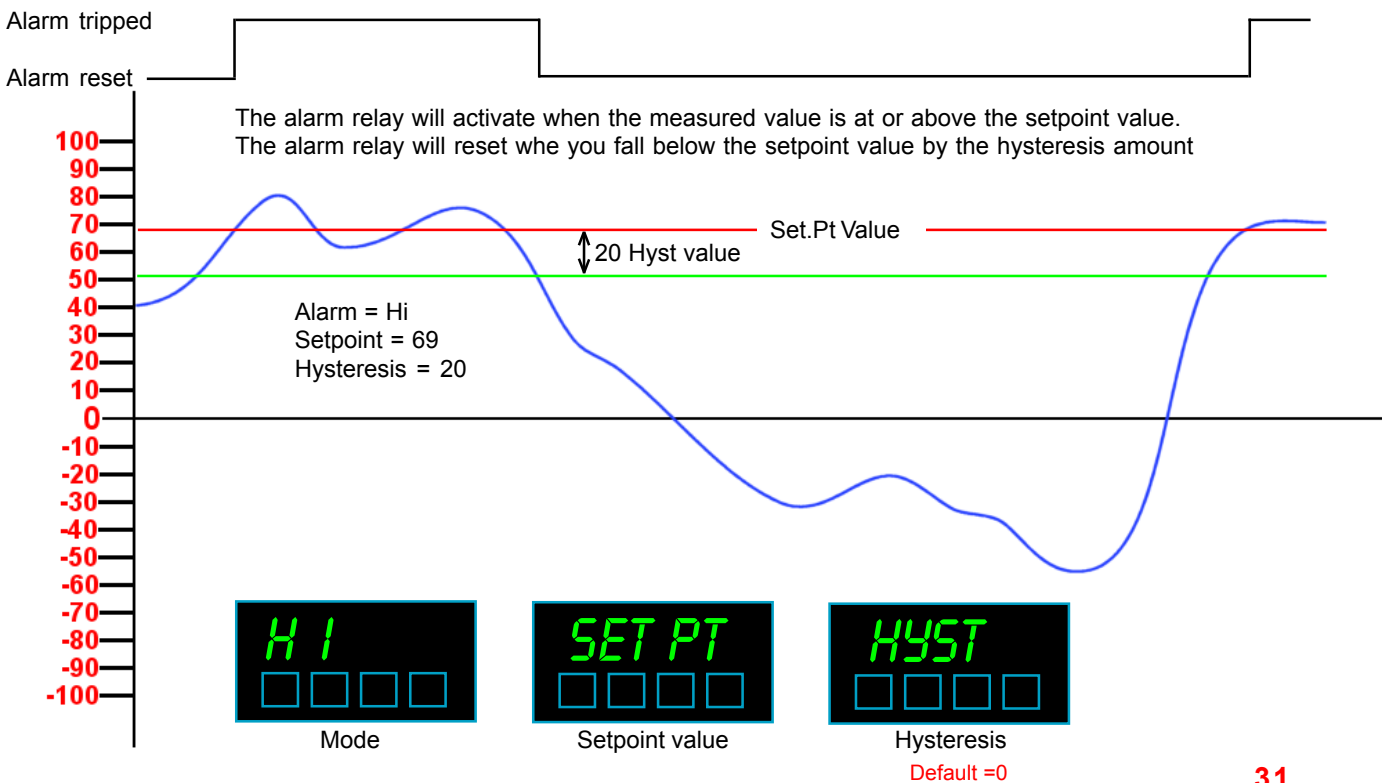

## Lo Alarm relay action, no hysteresis

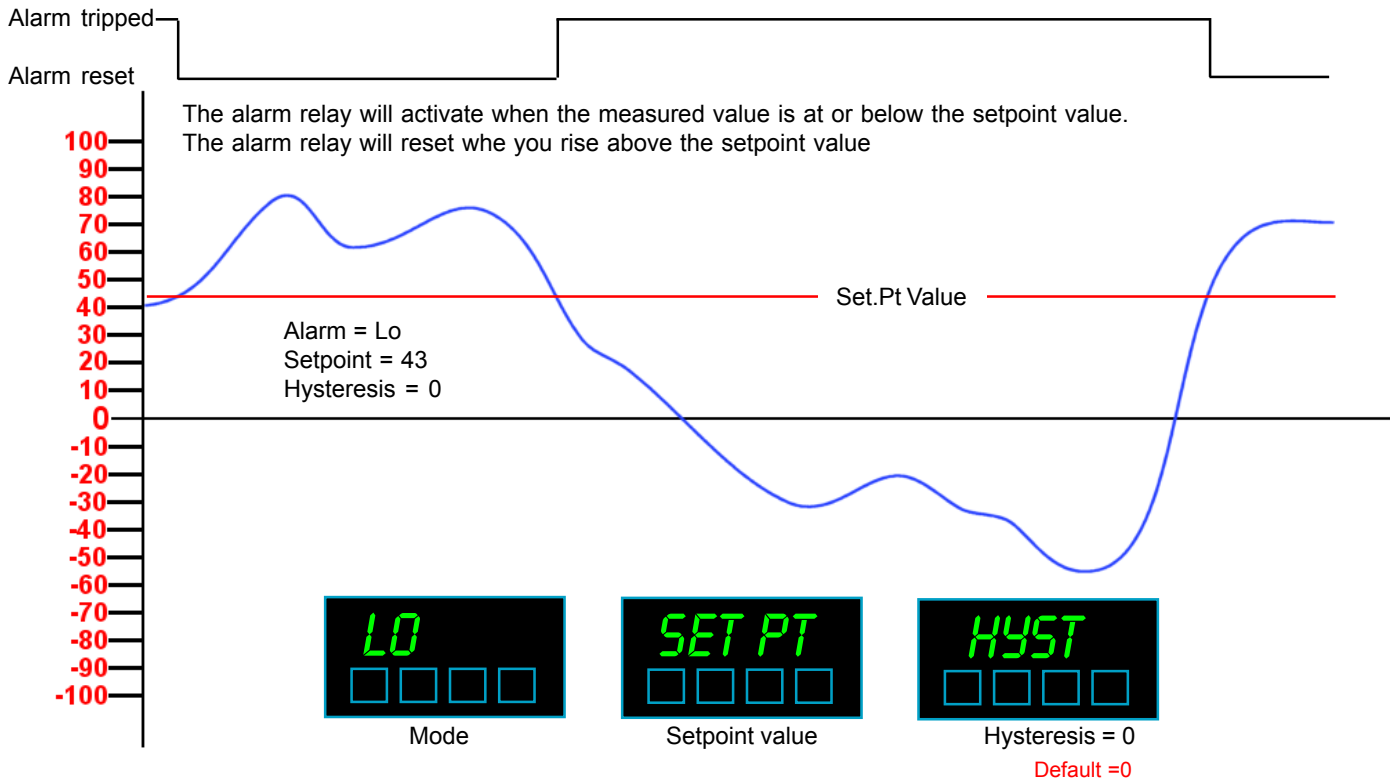

## Lo Alarm relay action with Hysteresis

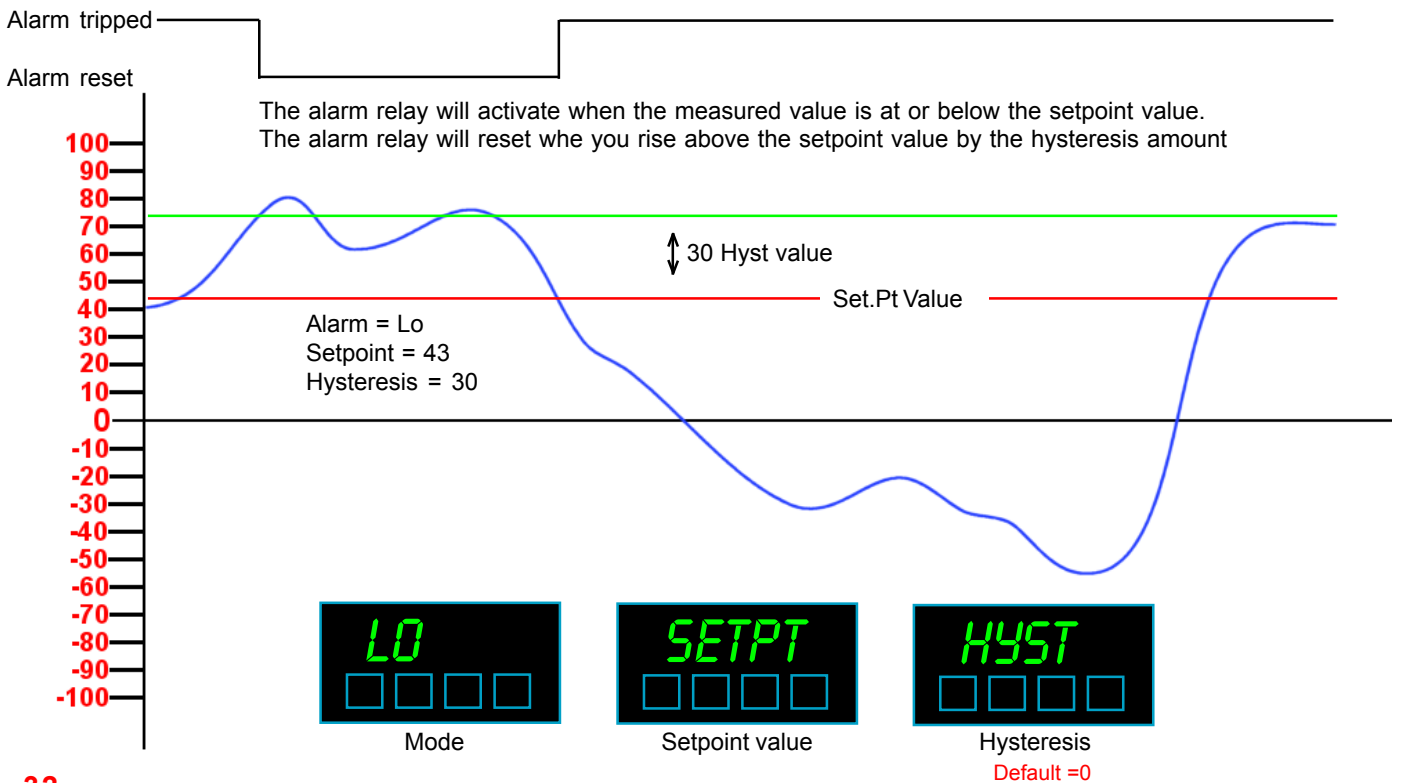

# InFlight Hi Alarm relay

The In-Flight alarm modes are used in applications where you want to accurately fill one container from another.

If you were to simply close the shutoff valve when the weight reaches your desired amount, you would find that the weight is higher than you'd hoped for.

This is because some material is still in mid-flight when you send the alarm signal to shut the valve, and the valve will take some time to fully close.

The load measured on the loadcell platform will continue to increase after the alarm signal is sent to the shutoff valve.

The InFlight modes subtract or add this "In-Flight" amount from the setpoint to ensure that your final fill amount is as close as possible to your desired value.

In automatic mode, the unit will note the error after the first fill and try to correct for it on the next fill by moving the trip point by all the error amount on the 2nd fill and by half the subsequent error amount on each following fill. It will constantly monitor the error and correct by half that amount, to ensure a smooth trend towards accurate filling.

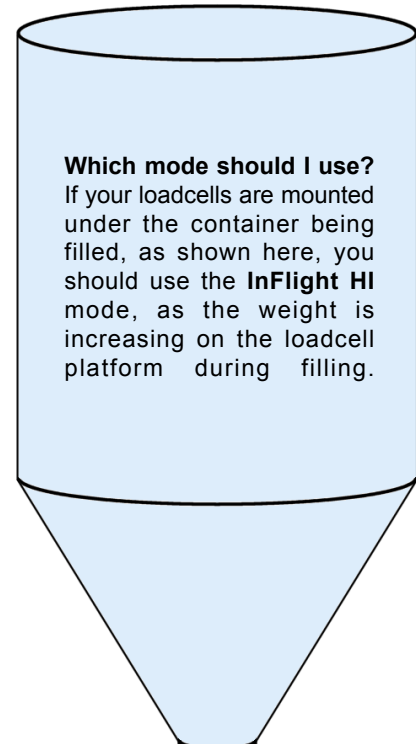

## Which mode should I use?

If your loadcells are mounted under the container being filled, as shown here, you should use the **InFlight HI** mode, as the weight is increasing on the loadcell platform during filling.

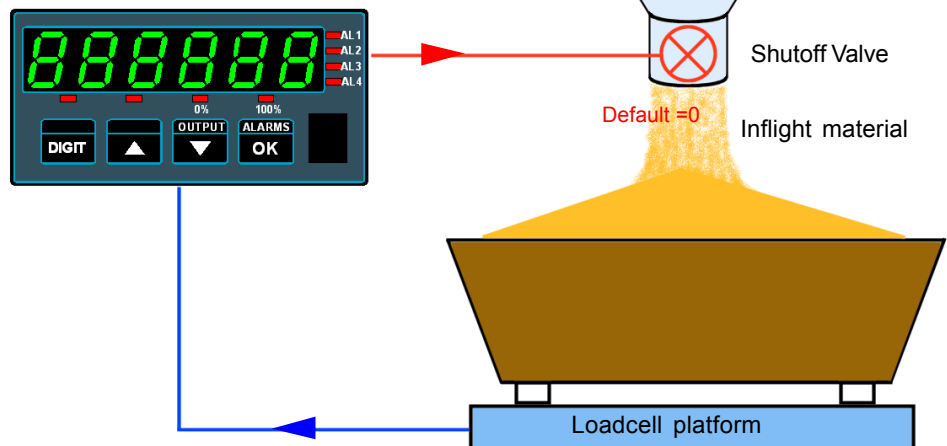

## Manual or Automatic ?

You can set a manual value for the Inflight amount, if you know how much in-flight material will continue to fall into the container after the shutoff valve has been triggered, and if this value is likely to remain consistent from fill to fill.

If you don't know the inflight amount or if the material flow properties may change from batch to batch, you can use the automatic mode.

To set, press the alarm button until you illuminate the alarm LED channel you want to change. Press the alarm button again for around 6 seconds, you will see "Set.Pt" followed by "AL CFG". Use the Digit, UP/Down buttons and OK to set.

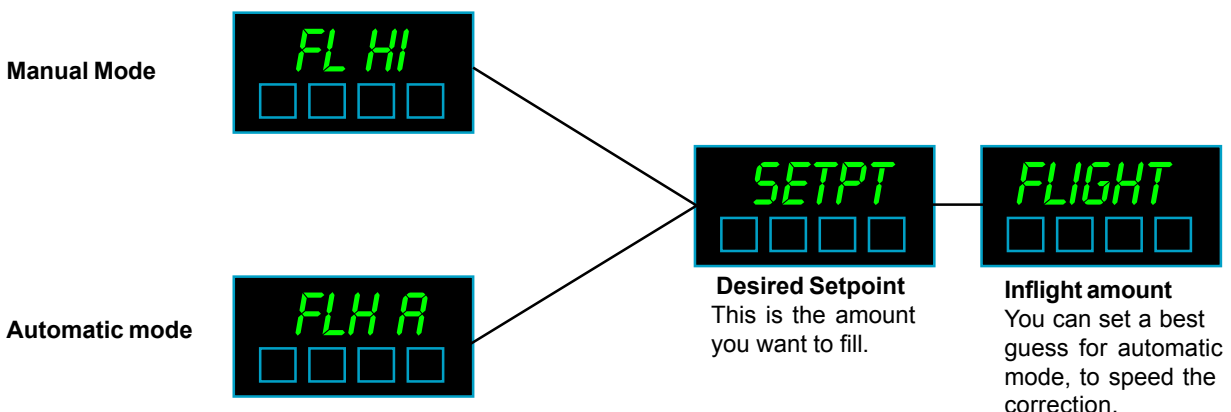

# InFlight Lo Alarm relay

The In-Flight alarm modes are used in applications where you want to accurately fill one container from another.

If you were to simply close the shutoff valve when the weight reaches your desired amount, you would find that the weight is higher than you'd hoped for.

This is because some material is still in mid-flight when you send the alarm signal to shut the valve, and the valve will take some time to fully close.

The load measured on the loadcell platform will continue to increase after the alarm signal is sent to the shutoff valve.

The InFlight modes subtract or add this "In-Flight" amount from the setpoint to ensure that your final fill amount is as close as possible to your desired value.

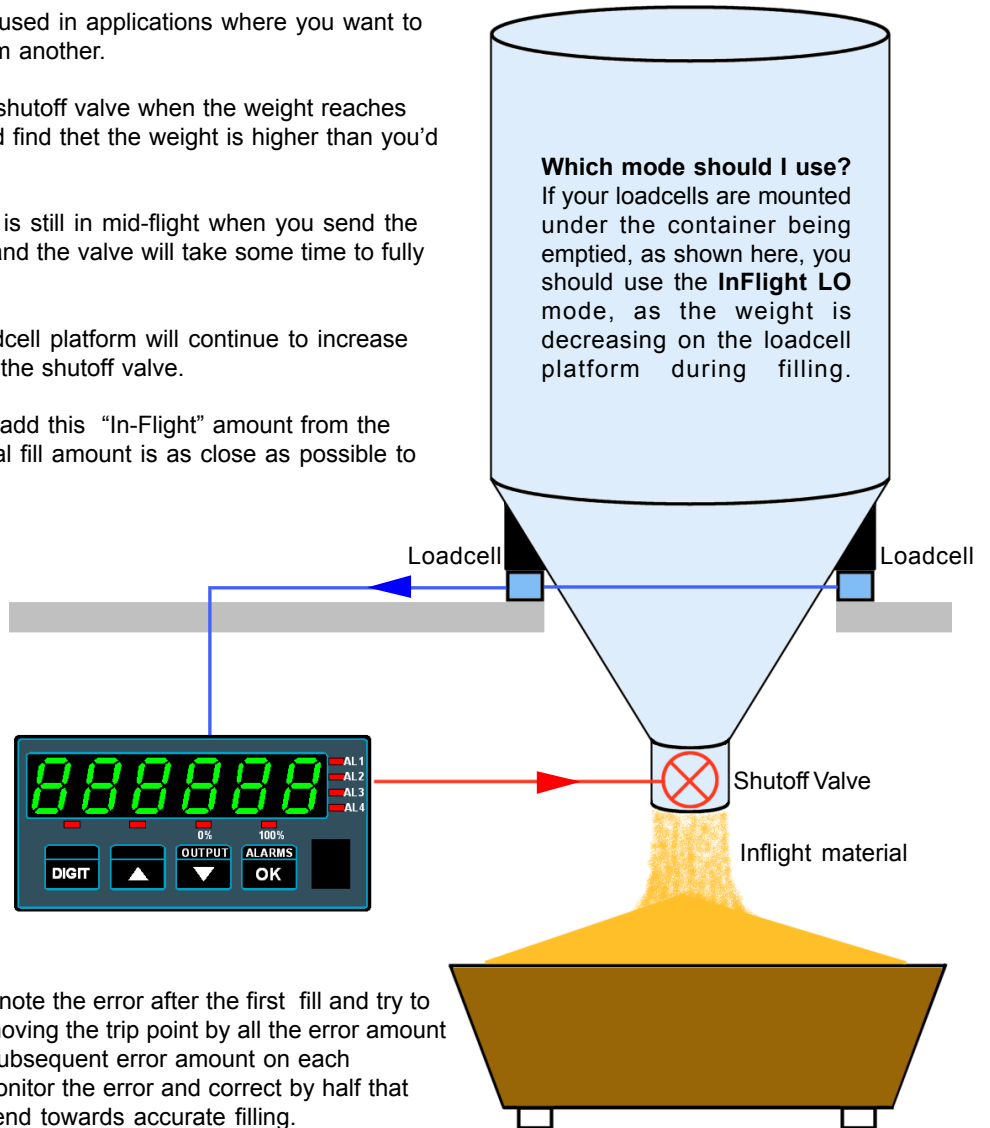

In automatic mode, the unit will note the error after the first fill and try to correct for it on the next fill by moving the trip point by all the error amount on the 2nd fill and by half the subsequent error amount on each following fill. It will constantly monitor the error and correct by half that amount, to ensure a smooth trend towards accurate filling.

## Manual or Automatic ?

You can set a manual value for the Inflight amount, if you know how much in-flight material will continue to fall into the container after the shutoff valve has been triggered, and if this value is likely to remain consistent from fill to fill.

If you don't know the inflight amount or if the material flow properties may change from batch to batch, you can use the automatic mode.

To set, press the alarm button until you illuminate the alarm LED channel you want to change. Press the alarm button again for around 6 seconds, you will see "Set.Pt" followed by "AL CFG". Use the Digit, UP/Down buttons and OK to set.

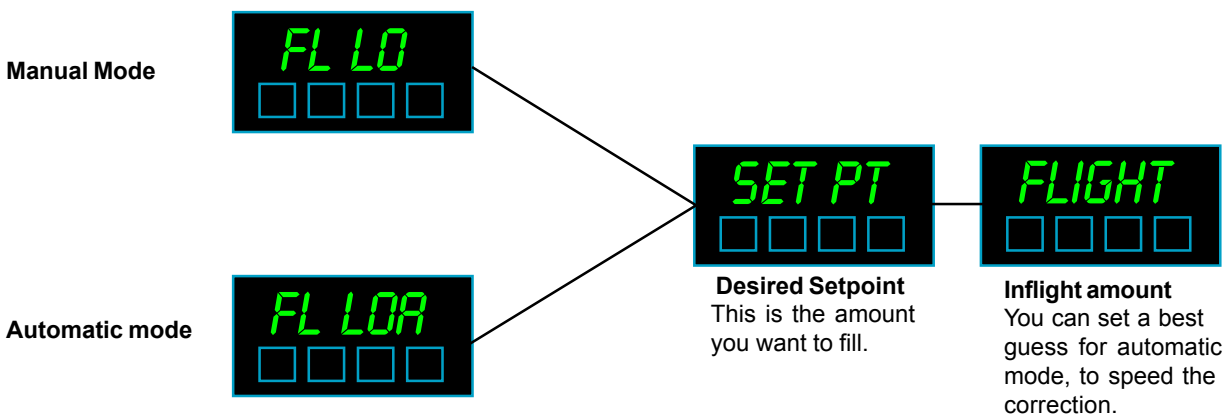

## In-Band Alarm relay

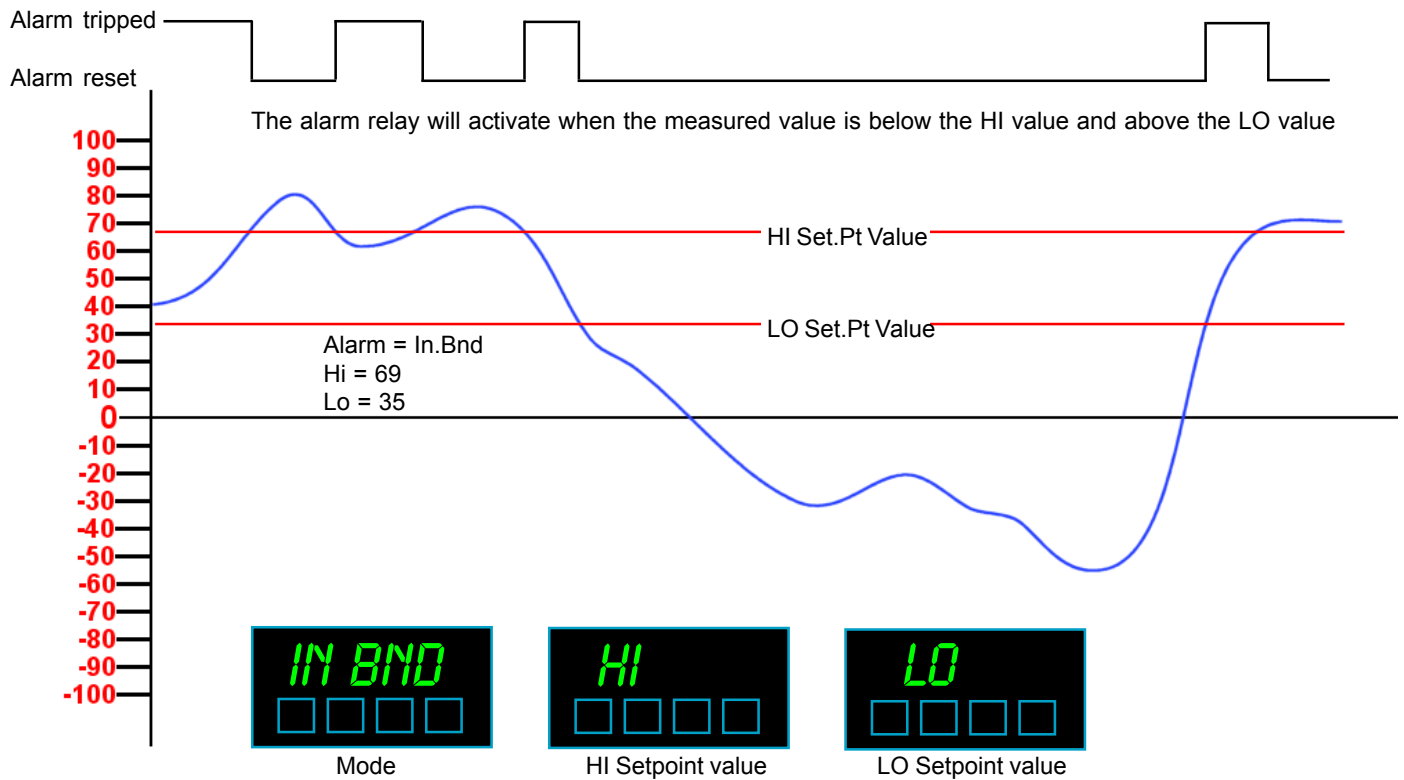

## Out-Band Alarm relay

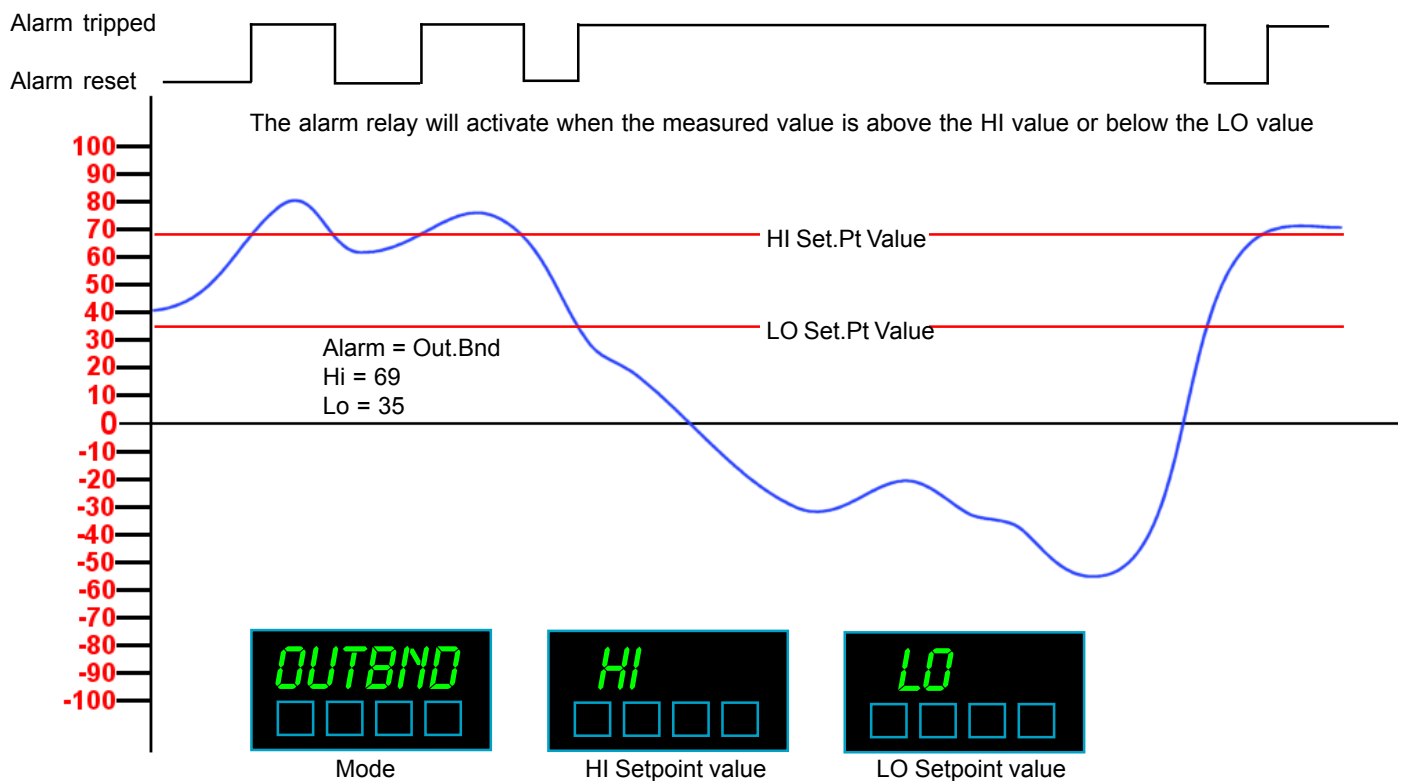

# Serial Output - page 1

 Where the product is intended for “UL” installations removal or addition of option boards is not permitted.

 **Warning:** Disconnect all power before exposing the rear of the meter

The serial output board plugs onto the 0, 2 or 4 alarm upper option board.

It plugs onto a pair of connectors and is secured by a snap-pillar.

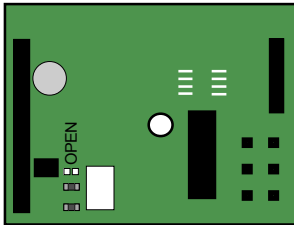

RS232 board  
No jumpers needed

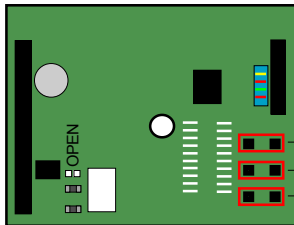

RS485 board  
 - If fitted, connects 120 Ohm terminator  
 - If fitted, sets a bias of +0V on Sig A  
 - If fitted, sets a bias of +5V on Sig B

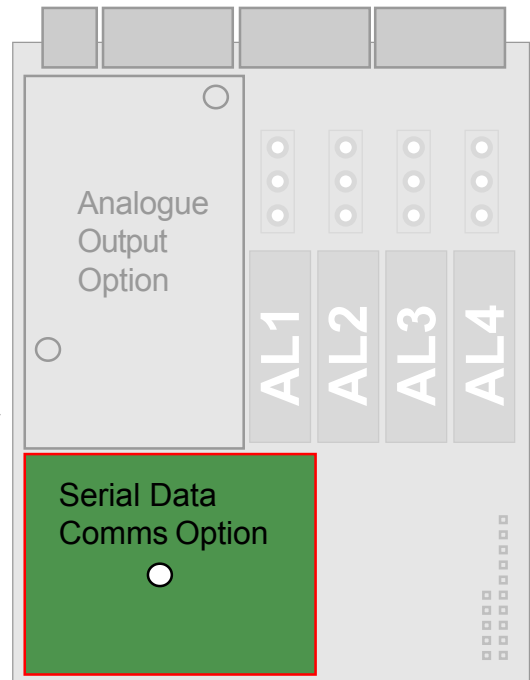

 **Warning:** Disconnect all cables from option board before adjusting

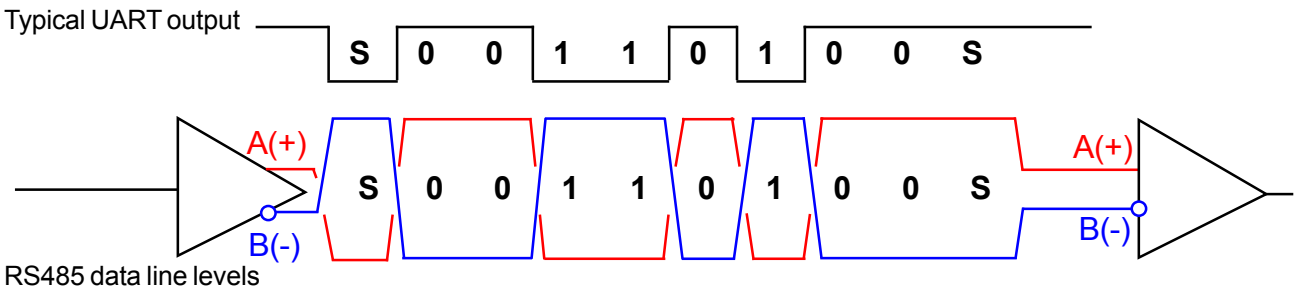

The 120 Ohm termination resistor should be fitted to only the last display on an RS485 data link, to improve noise immunity. A terminator should also be fitted on the sending device.

The bias jumpers are not normally fitted, but are available if your system needs biasing, to keep it in a valid idle state when data is not present.

Re-assemble the meter, apply power and follow the Serial Output Settings procedure on the next page.

## Handy Feature

You can tell if a serial output is fitted to your meter by viewing the ‘Summary’ display. Press the two outer buttons of the display for 3 seconds. You will also see the summary when you first switch on your meter.

# Serial Output - page 2

**Lockout notes:** Cal Lock switch = OFF when changing. Switch Cal Lock to ON after changing

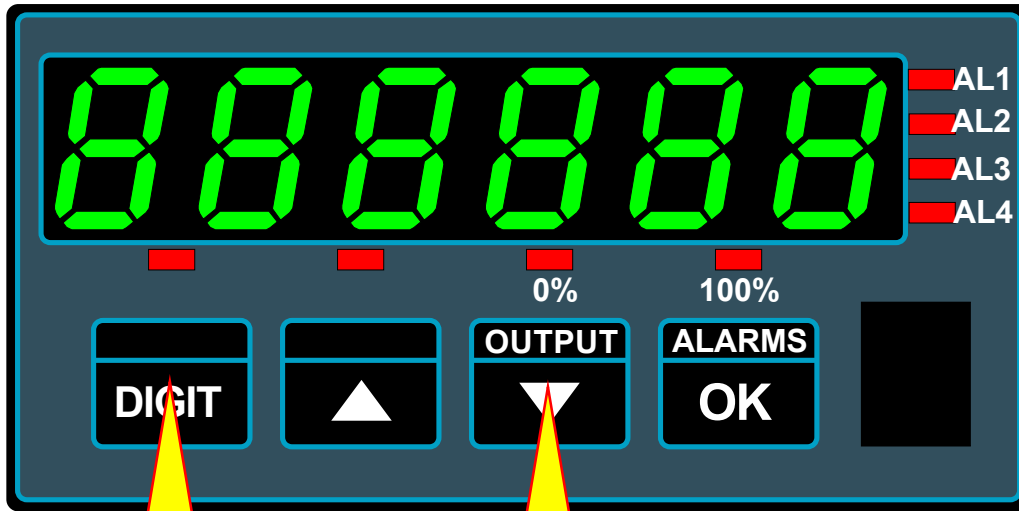

**Briefly press together**

**Baud** :- Select from 300,600,1200,2400,4800,9600,19200,38400, 57600,115200 **Default =9600**

**dF** = Data Format = 8n1, 7n1, 7E1, 701 **Default =8n1**

**Prot** = P1 (polled ASCII), P2 (Polled Modbus ASCII), C1 (Continuous), H1 (GPS) **Default =P2**

**Addr** = Address = 00 to FF **Default =F7**

**t.rEP** = Reply Delay time in milliseconds 00 to 99 **Default =05**

**t.Chr** = Character space timing in milliseconds 00 to 99 **Default =00**

## Protocol C1 – Continuous output (Enable line to common gives output)

Meter sends: 8 characters<CR>

e.g.

20 20 20 20 20 2D 31 37 0D	(-17) decimal position = 0
20 20 20 20 2D 31 2E 36 0D	(-1.6) negative value
20 20 20 20 20 31 2E 38 0D	(+1.8) positive value
20 20 20 20 20 20 4F 52 0D	(OR) over range
20 20 20 20 20 20 55 52 0D	(UR) under range

## Protocol H1 - GPS clock data format for use with our ASR-GPS

### Protocol P1 – Polled ASCII

Controller sends: <STX> ADDRH:ADDRL r <ETX> e.g. 02 46 37 72 03 ( to device F7)

Meter replies <STX> 8 characters <ETX>

e.g.

02 20 20 20 20 20 2D 31 37 03	(-17) decimal position = 0
02 20 20 20 20 2D 31 2E 36 03	(-1.6) negative value
02 20 20 20 20 20 31 2E 38 03	(+1.8) positive value
02 20 20 20 20 20 20 4F 52 03	(OR) over range
02 20 20 20 20 20 20 55 52 03	(UR) under range

### Protocol P2 – Polled ASCII Modbus - See next page

When you have finished setting the meter, put the lockout switch in its ON position now, to prevent your settings from being changed.

# Modbus ASCII

Select protocol **P2**, using the previous page.

The displayed value is available as a 32 bit 2's compliment signed integer in registers **0x0000** and **0x0001**

Register **0x0000** Display value low word

Register **0x0001** Display value high word

The decimal point position is available in the low byte of register **0x001E**.

The high byte is not currently used, but should be masked off to guarantee compatibility with future firmware releases.

Some examples:-

<b>If meter shows 9</b>	Display value reads 9	Decimal position reads 0
<b>If meter shows 9.9</b>	Display value reads 99	Decimal position reads 1
<b>If meter shows 9.99</b>	Display value reads 999	Decimal position reads 2
<b>If meter shows 9.999</b>	Display value reads 9999	Decimal position reads 3

# Real Time Clock settings

An optional real time clock module may be fitted to the display. Most often, this is to allow date and time stamps to be included in serial data transmissions.

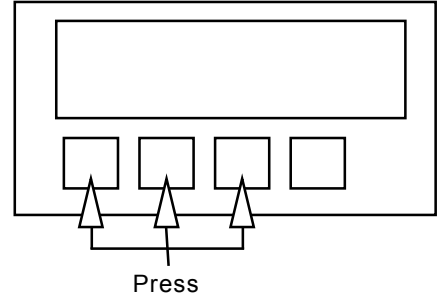
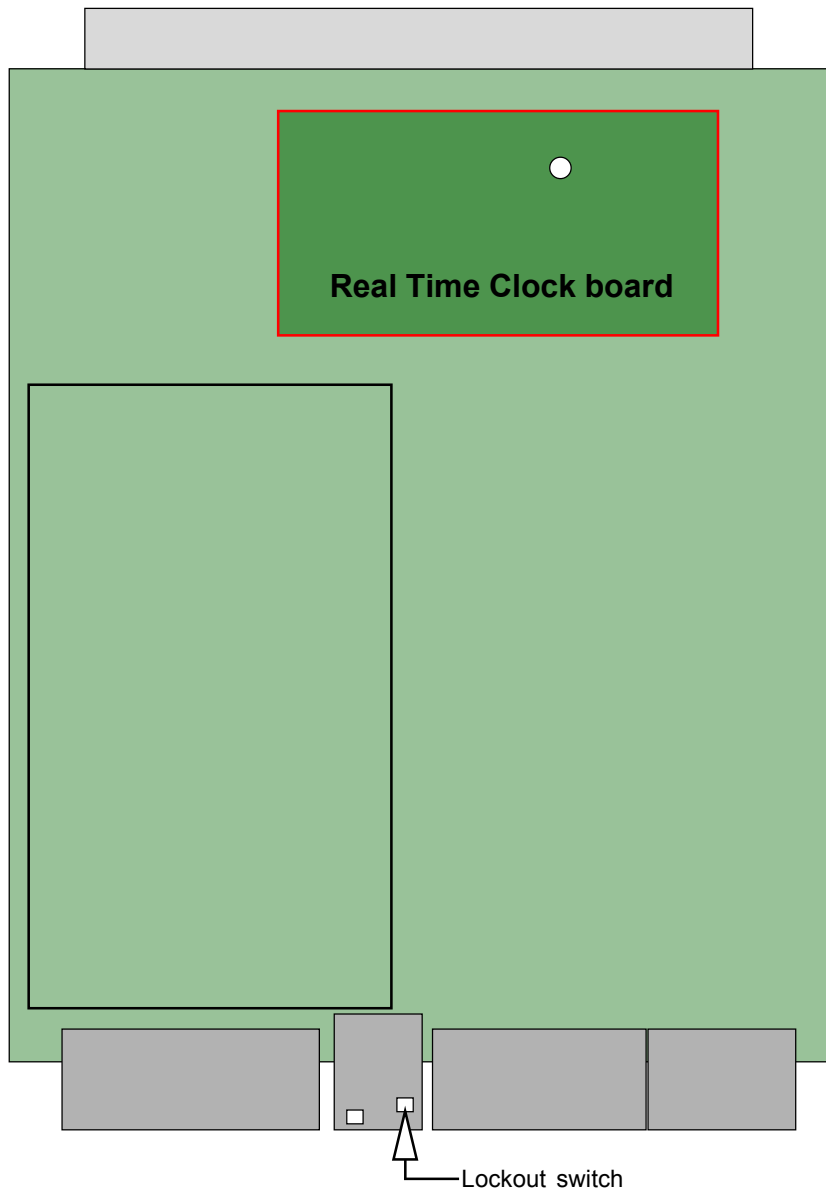

To access the settings, you will need to move the lockout switch to its OFF position  
Press the 3 left buttons together for 3 seconds

Then use UP or DOWN buttons to set the date and time, press OK to accept.

yr = year 10=2010 etc  
m = month 01 = January  
dt = day of month 01 to 31  
XX:XX = hour 00 to 23  
XX:XX = minutes 00 to 59

Then you will see XX:XX with 4 x flashing LEDs  
Press OK at the exact time you set.

## Mode Settings

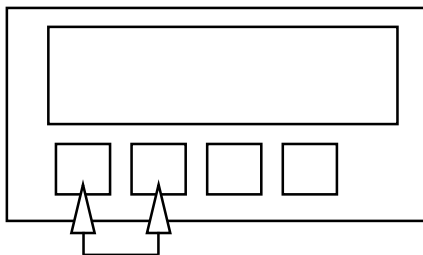

Press > 3sec.  
to set modes

1. 12/24 hour : Use UP/DOWN button to choose, then press OK.
2. Daylight saving Off, EU, US: Use UP/DOWN button to choose, then press OK.  
Choose to suit your location.
3. Sync. ON/OFF: Use UP/DOWN button to choose, then press OK .  
Choose ON if using an ASR-GPS master.

# Logic input connections and functions

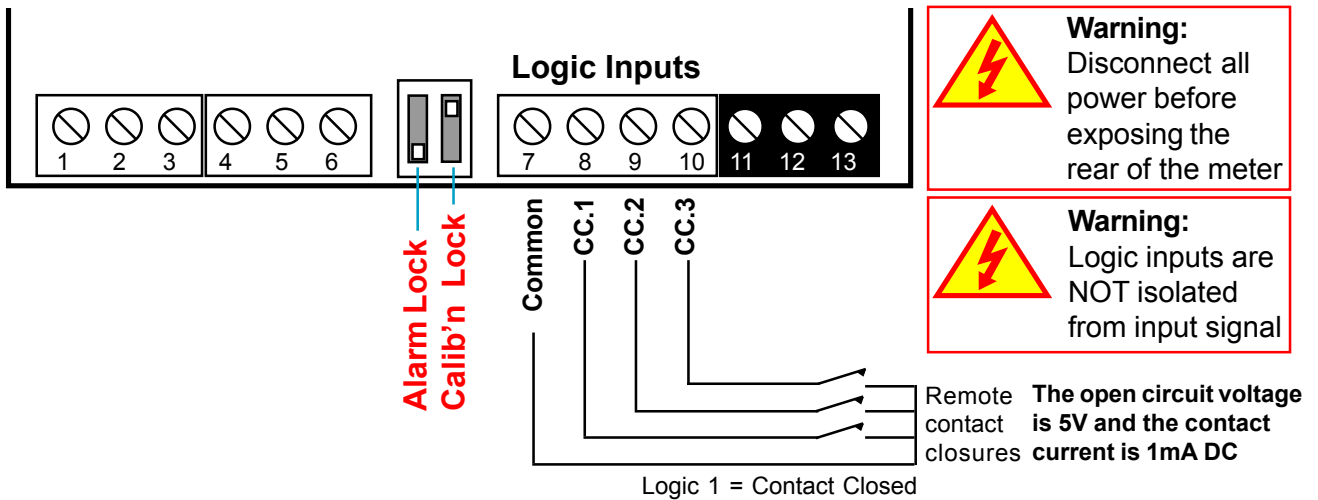

You can choose the function of each of the three Contact Closure logic inputs. Set the calibration lockout switch in its upper position. Then press the Output and Alarms buttons together for approx 1/2 second. Press OK button until you see CC.1. Press the UP or DOWN button to choose the function of CC.1, then press OK.

Now you can set CC.2 and CC.3 in the same manner.

Contact Closure Connector			<span style="background-color: yellow; border: 1px solid black; padding: 2px;"> </span> = Factory default <b>Chosen connector function</b>
CC.1	CC.2	CC.3	
<span style="background-color: yellow; border: 1px solid black; padding: 2px;">Tare</span>	Tare	Tare	Tare display to 0
PV	<span style="background-color: yellow; border: 1px solid black; padding: 2px;">PV</span>	PV	View Peak or Valley memory
rSt	rSt	<span style="background-color: yellow; border: 1px solid black; padding: 2px;">rSt</span>	Reset tare, peak, valley, alarm latch
hold	hold	hold	Freezes display
net.gro	net.gro	net.gro	Toggles between nett & gross
If the MEM08 multi-page memory option has been installed, the following options will also be available ...			
PA.1	PA.1	PA.1	Page Address 1 (binary)
PA.2	PA.2	PA.2	Page Address 2 (binary)
PA.4	PA.4	PA.4	Page address 4 (binary)

**COP.1** = Copy these settings to all other page addresses. Set this before you set up your first page, so that all other pages will share the same contact closure functions.

**COP.0** = Do not copy these settings to all other page addresses. Use this after you have set any global parameters, and now want to make unique settings for each page.

**Example:-** if you want 4 pages of memory plus a tare control for each page, set COP.1 , set CC.1=PA.1, CC.2=PA.2 and CC.3=Tare

When you have finished setting the functions of the contact closure terminals, Set COP.0 and return the lockout switch to its DOWN position, to prevent accidental alterations.

# Peak, Valley, Tare, Hold, Net/Gross and Reset

By default, CC.1 input acts as a Tare input.  
 By default, CC.2 input acts as a Peak/Valley view input.  
 By default, CC.3 input acts as a Reset input.

These contact closures will only be active if the calibration lockout switch is in its ON position (down)

You can also have Tare, Peak/Valley view, Net/Gross, and Reset on the front panel of the meter. To activate these functions, you must connect the Common terminal of the Logic Input connector to the CC terminal function you want available on the front panel. If you want to connect remote pushbuttons to the logic inputs AND use the front panel pushbuttons, you must use normally closed pushbuttons.

If your meter has the MEM-08 option installed, you will not be able to use all the rear contact closure Peak, Valley, Tare and Reset functions, but you will be able to use the front panel buttons for these functions

## Optional MEM-08 option functions

If your meter has had the MEM-08 option installed, you can allocate up to 8 individual pages of different setup data.

You don't need to enable all pages, however. For example, if you wanted only 2 pages, perhaps to allow you to switch between DegC and DegF, you need only set CC.1=PA1, CC.2=PV and CC.3=rST

The logic map for the full page selection is....

CC.3	CC.2	CC.1	
0	0	0	Page 0
0	0	1	Page 1
0	1	0	Page 2
0	1	1	Page 3
1	0	0	Page 4
1	0	1	Page 5
1	1	0	Page 6
1	1	1	Page 7

In this example, CC.1, CC.2 and CC.3 are each set with individual page addresses, PA.1, PA.2 and PA.3

0 = Contact open  
 1 = Contact connected to common

CC.3	CC.2	CC.1	
X	0	0	Page 0
X	0	1	Page 1
X	1	0	Page 2
X	1	1	Page 3

In this example, CC.1 and CC.2 are each set with individual page addresses, PA.1 and PA.2. CC.3 can be used for Tare, PV or Reset

0 = Contact open  
 1 = Contact connected to common

CC.3	CC.2	CC.1	
X	X	0	Page 0
X	X	1	Page 1

In this example, only CC.1 is set with an individual page address, PA.1  
 CC.2 and CC.3 can be used for Tare, PV or Reset

0 = Contact open  
 1 = Contact connected to common

## Reverse/Mirror/Heads-Up display

The display can be 'mirror-imaged' to allow it to be viewed as a reflection in a rear-view mirror, windscreen or other reflective surface.

This can be useful for creating 'heads-up' displays, for some test installations where the display will be viewed in a mirror, as a display for drivers reversing large vehicles, etc.

### Reverse / Mirror display

Press both buttons briefly, press OK 5x

Change with UP/DOWN button. OK=Accept

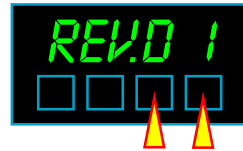

Calibration lockout OFF

Choose Rev.d 0 for normal display

Choose Rev.d 1 for reflected display

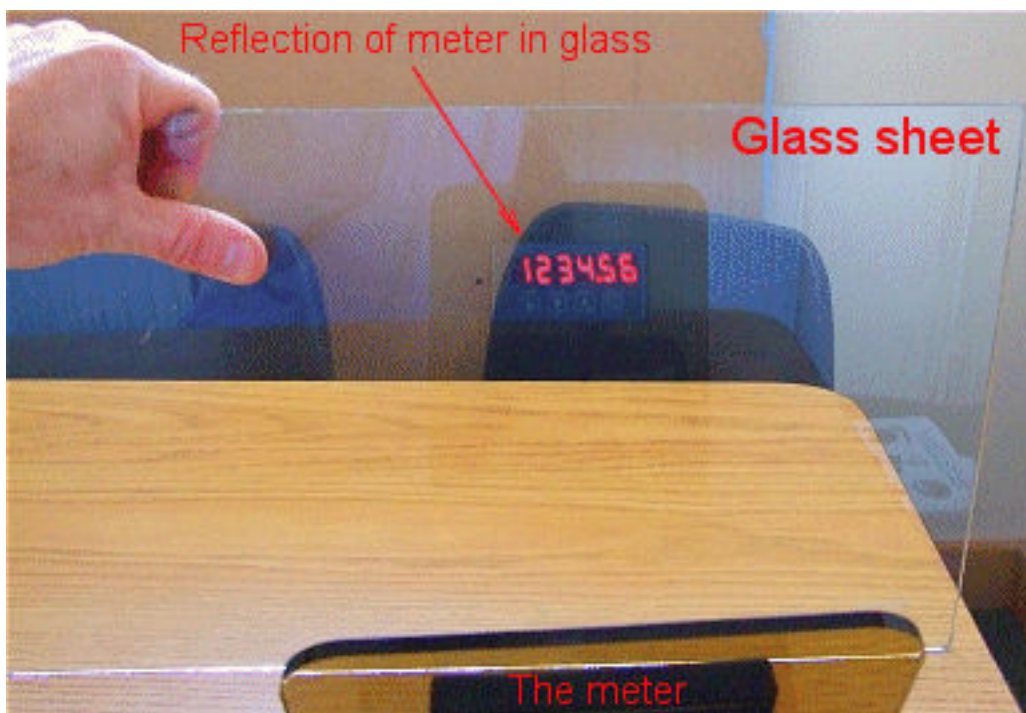

# Equipment Specifications

<b>Bezel size</b>	48mm high by 96 mm wide (1/8 DIN)			
<b>Panel Cutout</b>	45 mm high by 92 mm wide			
<b>Case Depth</b>	125 mm including connectors			
<b>Weight</b>	300 grammes			
<b>Case Material</b>	Black polycarbonate			
<b>Connectors</b>	Detachable Screw Terminal connectors			
<b>Environmental</b>	Storage Temperature range -20 to +70C, non condensing Operating temperature range 0 to 50C, non condensing Front sealed IP65.			
<b>Power Burden</b>	100-240 VAC, 45 to 60Hz or 11-30 VDC optional 10VA maximum			
<b>Input Signals (bipolar)</b>	4 to 20mA, 0-10V, 1-5V, 0-5V bipolar			
<b>Input Resistance</b>	>1 Megohms for voltage, 33 Ohms for current			
<b>Accuracy</b>	+/-0.05% of range			
<b>Span tempco</b>	25 ppm/Degree Celsius			
<b>Zero Tempco</b>	30 ppm/Degree Celsius			
<b>Excitation voltage</b>	24VDC nominal rated at 40mA.			
<b>Filtering / smoothing</b>	Selectable time constants of 0 to 5 seconds.			
<b>A/D conversion</b>	Sigma-Delta 10 conversions per second, 50/60Hz rejection Resolution 1 in 400 000 max. over full range			
<b>Display update rate</b>	10 readings per second.			
<b>Display Range (max)</b>	-199999 to +199999, depending on available signal level.			
<b>Plug-In Output Options</b>				
<b>Analogue O/P</b>	0-10VDC	-10 to +10V	0-20mA	4-20mA
Drive capacity	>1K Ohms	>1K Ohms	<500 Ohms	<500 Ohms
Isolation	250 VAC Optically isolated			
Accuracy	+/-0.1% range, +/-10mV for ANV, +/-10uA for ANI, 50ppm/C stab.			
Linearity	+/-0.02% of range			
Resolution	better than 0.2mV for 10v, 0.4uA for 20mA range			
Scaling	Fully adjustable, direct or inverse			
<b>Alarm Relay O/P</b>	2 or 4 alarms SPST rated 2 Amperes at 250 VAC, resistive load. All relays must switch power from the same phase. Selectable normally open or normally closed by on-board switches. Selectable energise or de-energise on trip by menu Independant hysteresis on each alarm relay.			
<b>ASCII Data O/P</b>	RS232 or RS485			
Format	Selectable continuous or polled modes. Baud rates 300 to 115200			
Isolation	250 VAC optically isolated			
<b>Calendar/Clock option</b>	Accuracy better than +/- 10 seconds per month (DS3231SN) Battery backup during power loss. Battery = CR1620 3V Lithium			

## Record of revisions

1 May 2007	Released with F00.001 software
22 May 2007	Added RS485 logic level diagram
22 August 2007	Added Zener barrier application notes.
2 October 2007	F00.006 software. Linearisation added. Inflight compensation and band alarms added. Brightness setting added, Menu timeout delay added.
6 May 2008	Added 'General Description' page. Added power frequency spec. Mounting & Installation page added. Wiring Advice page added
27 May 2008	Added UL label sample to front page. Added ClassII connection details.
26 June 2008	Added Bootup option menu, screw torque, AWG wire gauges
8 Oct. 2008	Software version 11 released. Filter Jump Percentage added. Serial protocol H1 added for GPS time synchronisation. 4 char. prompt library included for use on 4 digit Fusion displays. Described software update method via front panel port. Added Reverse/mirror display for heads-up applications.
28 Oct. 2008	Version 12 software released. Includes enhancements for the counter version of the meter.
13 Nov. 2008	Amended VA ratings and added UL listed graphic.
21 Nov 2008	Version 14 software released, upgrading version 12 (no version 13). Corrects reset bug on totaliser and variable brightness bug.
9 Dec 2008	Added requirements for cULus fuse type and removed front panel programming reference.
15 Dec 2008	Added warning not to alter option boards in UL listed applications
5 March 2009	Connections page changed logic input labels to CC.1 to CC.3. Added MEM08 details
30 June 2009	Address update
13 Nov. 2009	Version F00.16 Software released Added Hold and Nett/Gross logic inputs Added Real time clock settings Added terminal numbering Added Modbus ASCII page Added relay timers Added Default setting notes Added factory default setting method

# Waste Electrical and Electronic Equipment (WEEE)

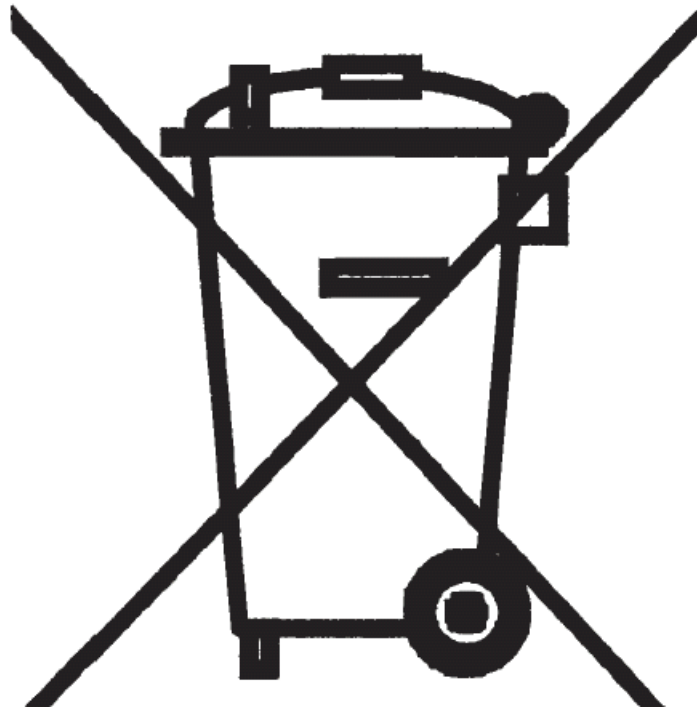

In Europe, this equipment must be disposed of in accordance with European Parliamentary Directive 2002/96/EC

This directive encourages recycling and the reduction of waste materials in the environment.

This means it must be sent to an approved recycling plant if you want to dispose of it.

It must not be thrown away in general rubbish.

If you are unable to dispose of this item locally, you may send it to us for recycling.

## **Conditions:**

1. We will only accept items of our manufacture.
2. You must pay for the transport of the goods to us.
3. We will only accept items if they include a signed declaration by an authorised person in your organisation, stating that :-
  - i. The item is safe to handle and has no contaminants which may be harmful to health.
  - ii. You wish us to dispose of or destroy the item(s)

# Notes

# Notes

# Declaration of Conformity

Declaration Reference : INTUITIVE Mk2  
Issue Date : 30 April 2007  
Products Covered : INTUITIVE Mk2 series  
Title : DOC-INTUITIVE2

This is to confirm that the Product covered by this declaration have been designed and manufactured to meet the limits of the following EMC Standard :

**EN61326-1:1997**

and has been designed to meet the applicable sections of the following safety standards

**EN61010-1:2001**

## Conditions

The meters are permitted a worst case error of 1% of A/D range during electro-magnetic disturbance, and must recover automatically when disturbance ceases without the need for human intervention, such as resetting, power-down etc.

The meters covered by this certificate must be installed in adherence to the following conditions :-

Signal cabling shall be routed separately to power carrying cabling (includes relay output wiring)  
All signal cabling shall be screened. The screen shall only be terminated to the power earth terminal

Declared as true and correct, for and on behalf of London Electronics Ltd.

J.R.Lees Director