

London Electronics Limited

Thorncote Green, Near Hatch, Sandy, Bedfordshire SG19 1PU
Tel +44(0)1767 626444 Fax +44(0)1767 626446
www.london-electronics.com help@london-electronics.com

Panel mounting counter / frequency / rate meter

INTUITIVE-C Mk.2

Connection details, scaling and general information



Caution: There is a risk of electrical shock if this instrument is not properly installed



Caution: Risk of danger: Read the whole manual before you install this meter

The New version of the INTUITIVE Family, with these extra benefits...

- * External selection of debounce, pullup/pulldown and sensitivity
- * 16 bit D/A convertor, greater analogue output resolution.
- * More comms options, for faster, more flexible data access.
- * Extra 'Factor and Offset' feature, allows you to correct for Gravity, Container Tare etc.
- * Simpler Alarm-Setpoint setting.
- * More alarm setting modes, including in-band and out of band alarms.
- * Summary Screen, lets you know which options are fitted, whenever you want to know.
- * Wider operating temperature range
- * Variable brightness feature
- * Adjustable menu timeout delay, to suit new and experienced users.
- * Online streaming step-by-step video guides at <http://london-electronics.com>

Ordering code: INT2-C-X-X-X-X-X

INT2 = Intuitive Mark 2 family

C = Counter / rate model

Analogue output: — **0**=none, — **ANI**=4-20mA, — **ANV**=0-10V

Alarm outputs: — **0**=none, — **AL2**= 2 relays, — **AL4**=4 relays

Serial data: — **0**= none, — **232**=RS232, — **485**=RS485

Display colour: — **R**=Red, — **G**=Green

Power: — **AC**=100-240V AC,— **DC**=11-30V DC

Software version F00.14

1

Contents

Alarm board configuration	19
Alarm programming	20-25
Analogue output	17-18
Basic meter startup settings	10
Bootup routine	10
Brightness Adjustment	11
Button Functions	12-13
Connections	9
Declaration of conformity	36
General Description	6
Input Configuration	15
Introduction	5
Keyboard timeout Delay	10
Language	10
Logic inputs	28
Modes and Scaling	14
Mounting and Installation	7
Notes	29, 34-35
Option boards- installing	16
Record of revisions	32
Reverse / Mirror / Heads-Up display	30
Serial output option	26-27
Specifications	31
Warnings	4
WEEE	33
Wiring Advice	8

Warnings

Please carefully read this manual and all warnings. Install the meter ONLY when you are sure that you've covered all aspects.



Where the product is intended for "UL" installations, removal or addition of option boards is not permitted.



Check that the model number and supply voltage suit your application before you install the meter.



Connect the meter according to current IEE regulations, IEC61010 & NFPA:70 National Electric Code in USA.



This meter is for Installation class II service only. This means it has exposed electrical and power terminals. You must install it in a suitable fire enclosure which will also protect users from electric shock



We designed this meter for Pollution-Degree 2 environments only.



Power supplies to this equipment must have anti-surge (T) fuses rated at 400mA for 230V supply, 400mA for 110V supply or 2A for DC supplies in the range 11-30VDC. Only Siba fuses in series 189500, cULus listed according to file #E167295 are accepted for this service under the terms of UL listing. A switch or circuit breaker, clearly marked as a disconnecting device, must be included close to the installation.



Don't touch any circuitry after you have connected the meter, because there may be lethal voltages on the circuit board.



Only adjust on-board switches or connections with the power turned off



Make sure all screw terminals are tight before you switch the meter on.



Only clean the meter's front with a soft damp cloth. Only lightly dampen with water. Do not use any other solvents. The behind-panel case may be cleaned with a dry cloth only, use no liquid or solvent on it.

**Safety FirstDon't assume anything..... Always double check.
If in doubt, ask someone who is QUALIFIED to assist you in the subject.**

Introduction

Please contact us if you need help, if you have a complaint, or if you have suggestions to help us improve our products or services.

If you contact us about a product you already have, please tell us the full model number and serial number, so that we can give you accurate and fast help.

This product has a 2 year warranty. We will put right or replace any meter which is faulty because of bad workmanship or materials. This warranty does not cover damage caused by misuse or accident.

IMPORTANT

If this equipment is important to your process, you may want to buy a spare to cover possible failure or accidental damage in the future.

This is because during factory shutdown periods, you may have to wait several weeks for an equivalent replacement, or we may have no stock at the time you urgently need it.

You may also need to pay extra carriage charges if you want a fast, guaranteed courier service. Warranty repairs or replacements are usually returned with a standard courier service.

We do not offer compensation for losses caused by failure of this instrument.

If you do not agree with these conditions, please return this item in unused, condition, in its original packaging and we will refund the purchase price, excluding any carriage paid.

We thought you'd prefer to know about possible delays and extra charges now, rather than during a panic. A spare unit could help to avoid these issues.

We always try to improve our products and services, so these may change over time. You should keep this manual safely, because future manuals, for new designs, may not describe this product accurately.

We believe these instructions are accurate, and that we have competently designed and manufactured the product, but please let us know if you find any errors.

General Description

The INT2 Series of meters accept industrial sensors to allow various physical measurements to be made, such as weight, temperature, pressure, humidity etc. Different models are available for different sensor types.

The main function of the INT2 series is to give a numeric readout of the variable being monitored. Most models include an excitation power output, to power the sensor directly.

Various optional output modules are also available to give alarm relay outputs, analogue output or digital communications, or any combination of these options.

Meters are programmed using front panel pushbuttons. The buttons may be locked with a rear switch.

Meters have two power supply options : 100-240 VAC or 11-30VDC

The INT2 series of meters are designed to mount into a protective enclosure which will protect users from contact with power and signal wiring.

These units must be installed fully assembled, and must be installed according to local electrical installation rules.

Safety



Caution: There is a risk of electrical shock if this instrument is not properly installed



Caution: Risk of danger: Read the whole manual before you install this meter

Obey all safety warnings in this manual, and install the meter according to local wiring and installation regulations. Failure to follow these guidelines may cause damage to the meter, connected equipment, or may be harmful to personnel.

Any moving mechanical device controlled by this equipment must have suitable access guards to prevent injury to personnel if the meter should fail.

Mounting and Installation - Class II

Install the INT2 Series of meters in a suitable protective electrical control enclosure according to local wiring regulations. See specifications for maximum allowable temperature in enclosure. Allow adequate air circulation.

Installing into front of panel

Remove the two rear bracket screws and safely store them and the U-Bracket for later fitting.

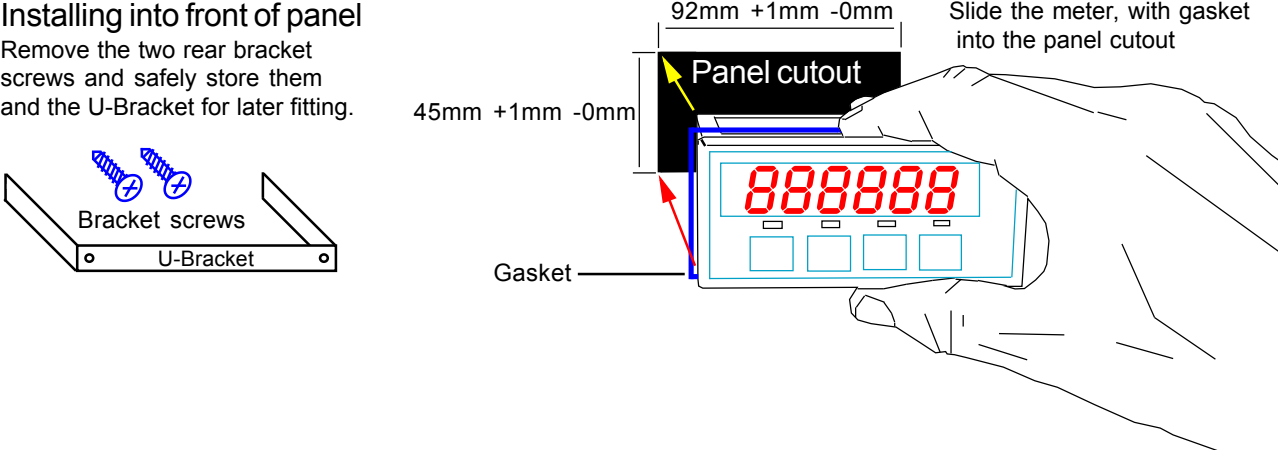

Slide the meter, with gasket into the panel cutout

92mm +1mm -0mm

45mm +1mm -0mm

Panel cutout

Gasket

Bracket screws

U-Bracket

Securing into the panel

Re-fit the U-Bracket and tighten the bracket screws to firmly clamp the meter in place. Check that the gasket is evenly pinched between the meter's front bezel and the enclosure front

Ventilation

There should be sufficient ventilation in the enclosure to ensure that the meter's case is always kept to less than 60C.

Meter Spacing.

Meters should be spaced apart sufficiently to allow a free flow of ventilation air around the meters, such that no part of the case will exceed 60C

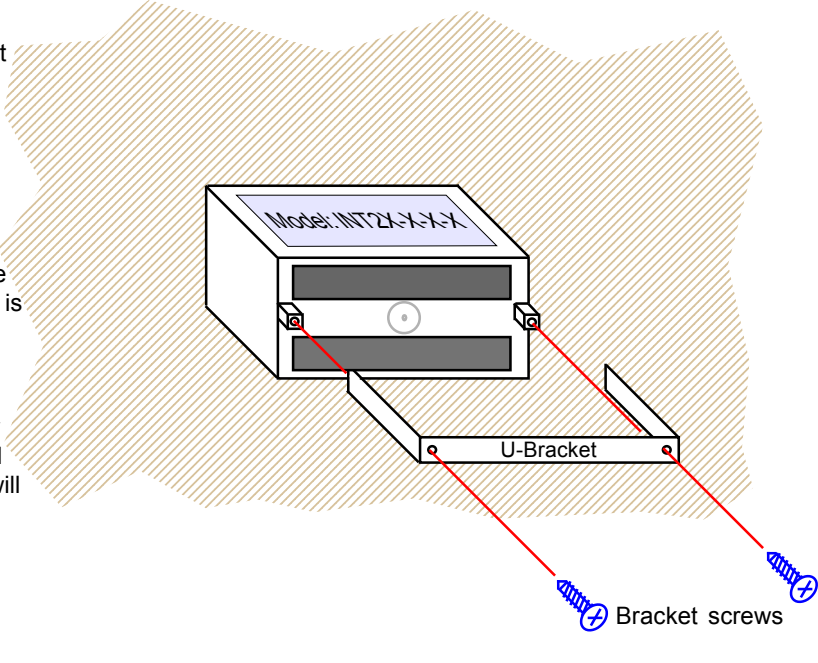

Model: INT2X-X-X-X

U-Bracket

Bracket screws

Side view of meter installed in panel

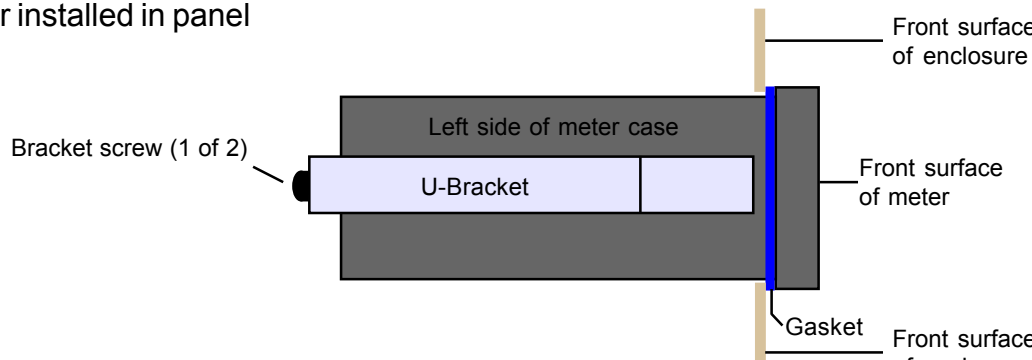

Bracket screw (1 of 2)

Left side of meter case

U-Bracket

Front surface of enclosure

Front surface of meter

Gasket

Front surface of enclosure

Wiring Advice

This meter uses detachable screw terminal connectors. Refer to the wiring diagram on the following page for the correct positioning of each wire.

The conductors you use must be suitable for the meter's temperature, current and voltage rating, which is broadly described as follows:-

Cable Temperature Rating

All cables must be rated for operation up to 90C continuous.

Cable gauge

The connectors on this instrument can accept conductors up to 1.5mm² c.s.a. The minimum cross sectional area shall be 0.5mm²

Cable insulation voltage rating

Cables shall have an insulation voltage rating of at least 380V continuous.

Wire preparation:

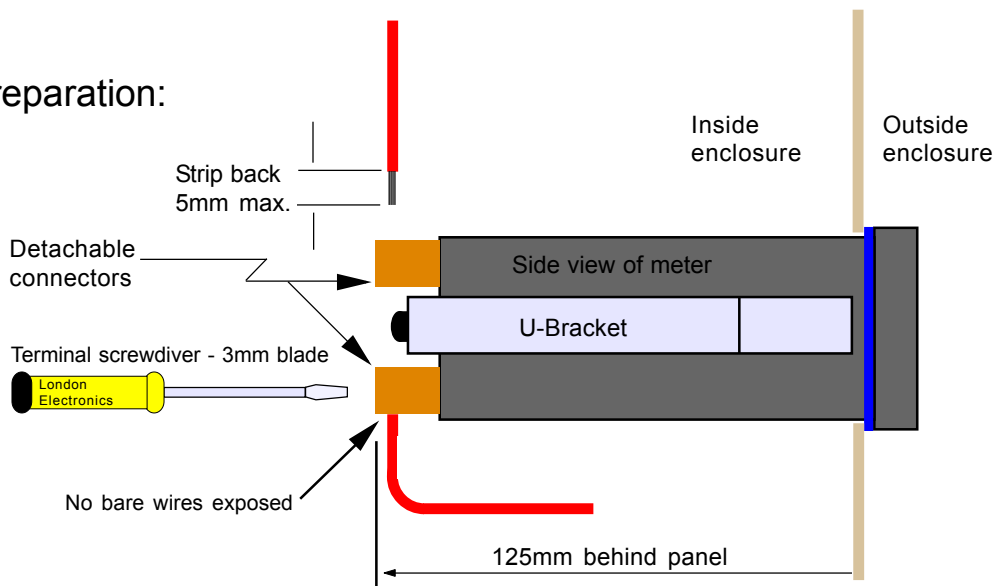

We recommend multi-strand wire, because it withstands vibration better than single strand cable. Pull the wire firmly after you make the connection to confirm it is tight.

Use screened cable for all signal and control wiring and connect the screen to earth at the destination end only. Route signal cabling away from power cabling and relay switching cabling, to avoid electrical noise interference.

Connections - INT2-C

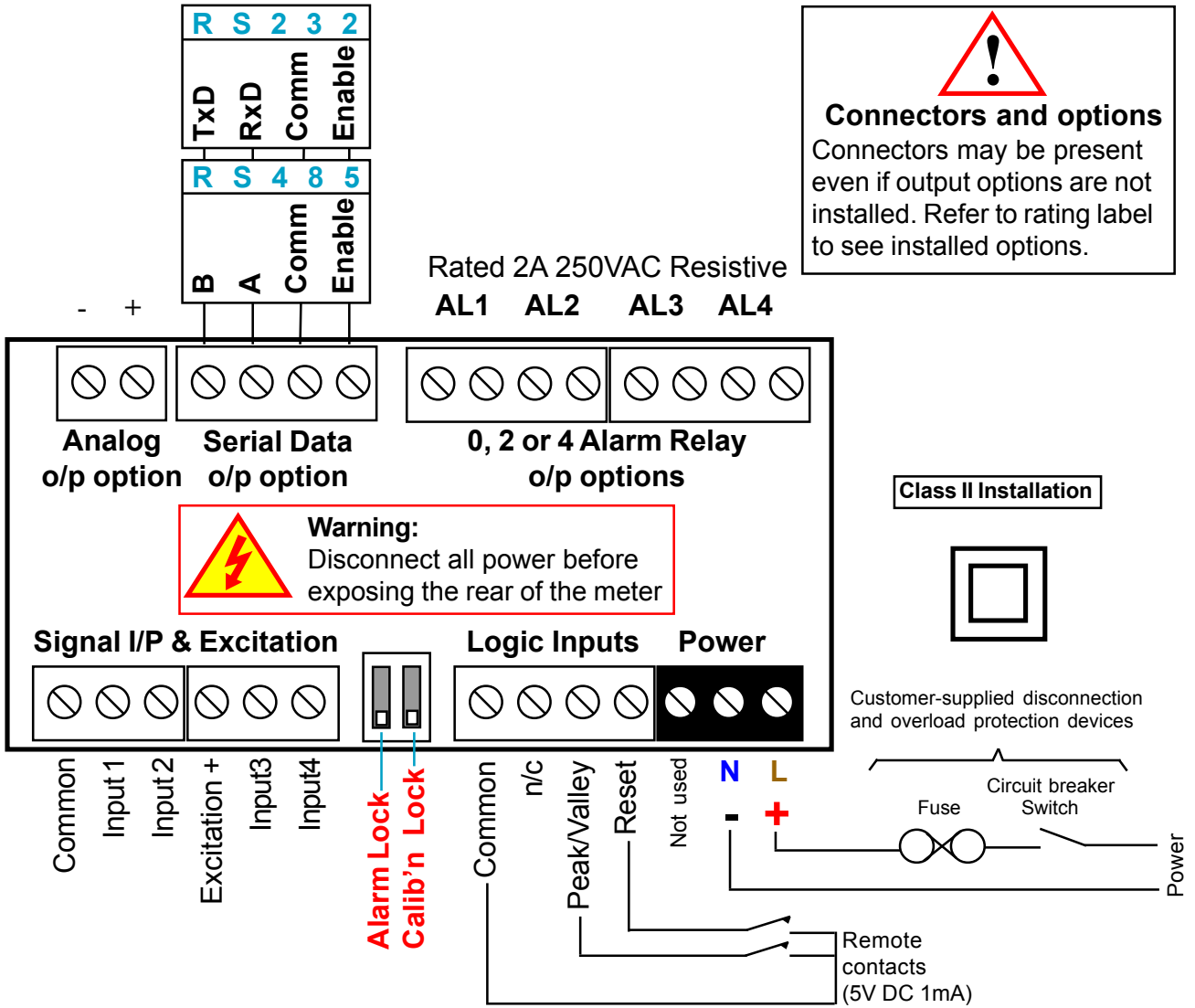

NPN or PNP Sensor

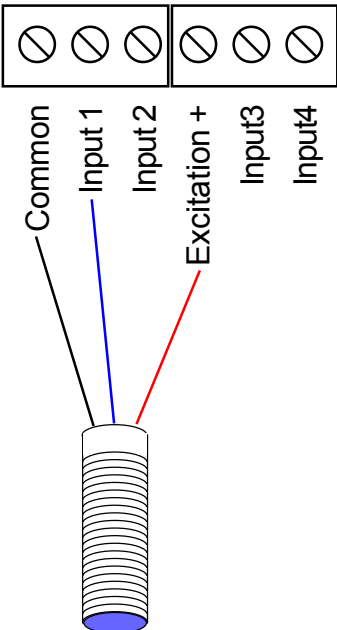

Contact Closure

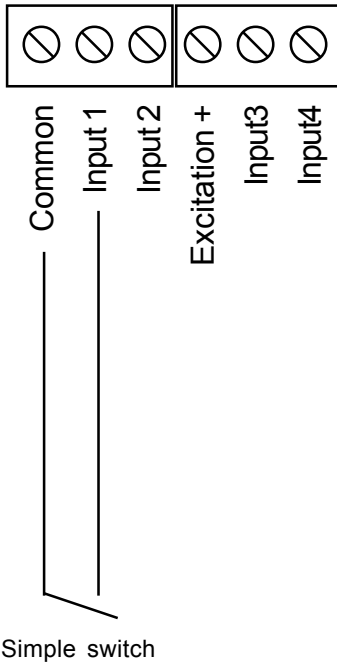

Up/Down count NPN

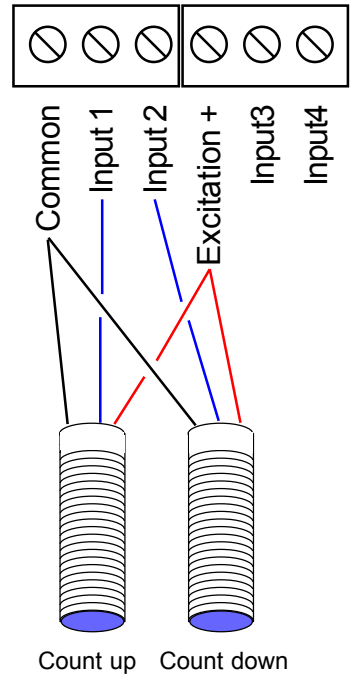

Basic startup meter Settings

Lockout notes: Cal Lock switch = OFF when changing. Switch Cal Lock to ON after changing

Menu Language Choice

Press the two right hand buttons briefly. You will see the **User Interface** language, which you can change with the UP or DOWN buttons. Accept with OK

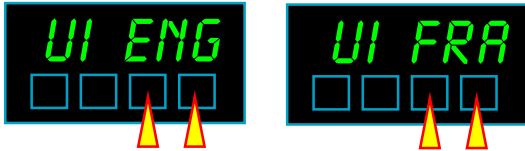

Next you will see ...

Meter Bootup routine



1. Activates all digit segments
2. Runs up and down brightness settings
3. Displays model number and installed options
4. Displays firmware version
5. Displays calibration audit number.
6. goes to meter mode



1. Activates all digit segments
2. Runs up and down brightness settings
3. Displays model number and installed options
4. goes to meter mode



1. Goes immediately to meter mode

When you switch the meter on, it can run through a summary list of software version number, installed options, calibration number etc.

You can choose from 3 lists of bootup information to be displayed, the less information you display, the sooner the meter will be available to operate.

Next you will see ...

Software de-bounce



You can enable a software debounce function for slow pulse rates, to limit pulses to once every 10 seconds. Select P.DB.0 to disable this function, or P.DB.1 to enable it.

Brightness Adjustment

Lockout notes: Cal Lock switch = ON when changing.

In normal operation, you can select from one of 8 brightness levels, to suit your local lighting conditions, or to match the brightness of several meters which may be from different batches or ages.









Press for 3 seconds, then press the down or up button to decrease or increase the brightness.

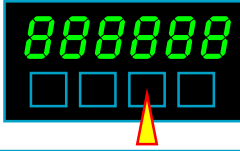



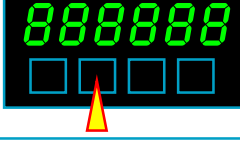

Press OK when set.

Your chosen brightness level will be saved in memory, so that the meter will return to the chosen brightness after power-off.

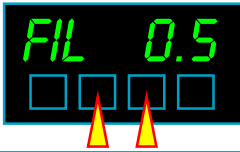
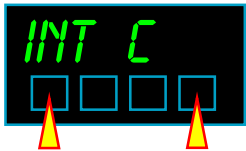
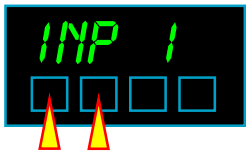
Button Functions- 'Quick-Step' - Page 1

Functions	Buttons	Conditions
Alarm Settings Press button briefly to view >3 seconds to change setpoint >5 seconds to change function		Can be viewed at any time. Alarm lockout OFF to change
Analogue Output Settings Press > 3 seconds to enter		Calibration lockout OFF
Brightness Press button for 3 seconds Change with UP/DOWN button. OK=Accept		Calibration lockout ON
Calibration Factor Press both buttons >3 secs, press OK 2x Change with UP/DOWN button. OK=Accept		Calibration lockout OFF
Calibration Offset Press both buttons >3 secs, press OK 3x Change with UP/DOWN button. OK=Accept		Calibration lockout OFF
Debounce - analogue filter Press both buttons >3 secs to enter input set. Change with UP/DOWN button. OK=Accept		Calibration lockout OFF
Debounce - digital filter Press both buttons briefly then press OK twice. Select 1 to enable, 0 to disable.		Calibration lockout OFF
Decimal Point position Press button 3 seconds, set during Scaling Change with UP/DOWN button. OK=Accept		Calibration lockout OFF

Button Functions- 'Quick-Step' - Page 2

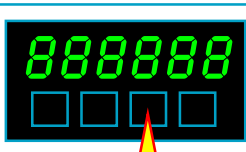
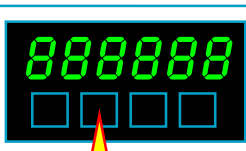
Functions	Buttons	Conditions
<p>Filter time constant for Rate</p> <p>Press both buttons >3 secs</p> <p>Change with UP/DOWN button. OK=Accept</p>		Calibration lockout OFF
<p>Hardware & Software summary</p> <p>Press both buttons >3 secs</p>		Can be viewed at any time
<p>Input Configuration</p> <p>Press both buttons for 3 seconds.</p> <p>Change with UP/DOWN button. OK=Accept</p>		Calibration lockout OFF
<p>Language& Boot-up mode</p> <p>Press both buttons briefly</p> <p>Change with UP/DOWN button. OK=Accept</p>		Calibration lockout OFF
<p>Last digit round-up</p> <p>Press both buttons >3 secs, press OK once</p> <p>Change with UP/DOWN button. OK=Accept</p>		Calibration lockout OFF
<p>Menu timeout delay</p> <p>Press both buttons briefly, press OK 3x</p> <p>Change with UP/DOWN button. OK=Accept</p>		Calibration lockout OFF
<p>Mode and Scaling</p> <p>Press button for 3 seconds.</p> <p>Change with UP/DOWN button. OK=Accept</p>		Calibration lockout OFF
<p>Reset Peak & Valley memories</p> <p>Press buttons briefly</p>		Calibration lockout ON Link terminals 7,10 and 8
<p>Serial Comms setup</p> <p>Press both buttons briefly</p>		Calibration lockout OFF
<p>Reset display to 0</p> <p>Press button briefly. Display shows 0.</p>		Calibration lockout ON and Link terminals 7 and 10
<p>Valley & Peak (Max. & Min.)</p> <p>Press button briefly, once for peak, next for valley.</p>		Calibration lockout ON Link terminals 7 and 9

Modes and Scaling

The INT-C2 has a number of useful operating modes. When you have chosen a mode, you can then scale the display. To select a mode, switch the lockout switch OFF and press the Set1 button for 3 seconds....

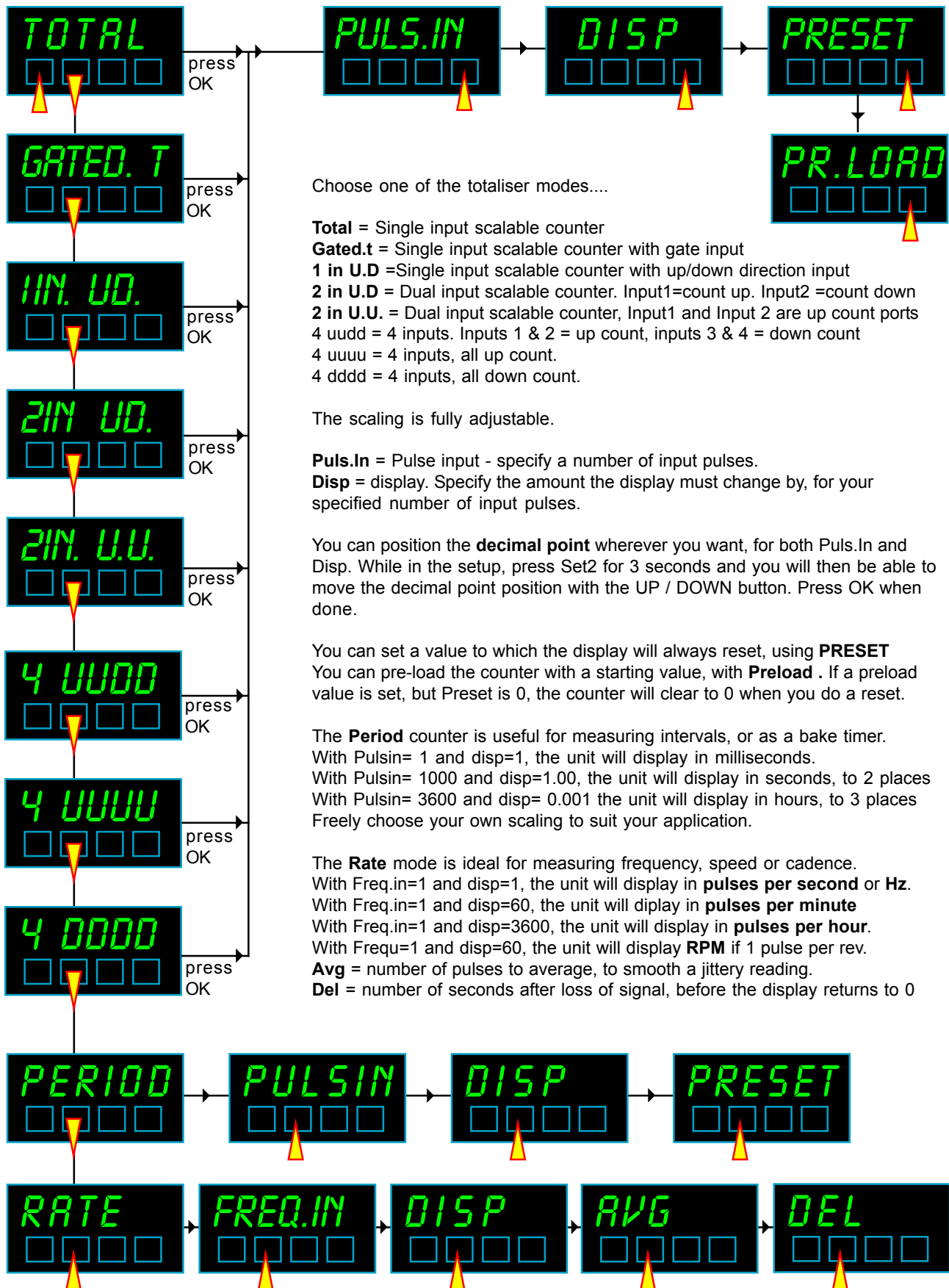

Input Configuration

You can configure the inputs, using the buttons, to accept AC, DC or low level inductive pulses. You can also choose whether to have a pull-down or pull-up resistor (for PNP, NPN or contact closure inputs) and whether to include de-bounce filtering, to minimise contact bounce effects. Each input can be configured independently. To configure the inputs, switch the lockout switch OFF and press Set1 and Set2 buttons together for 3 seconds...

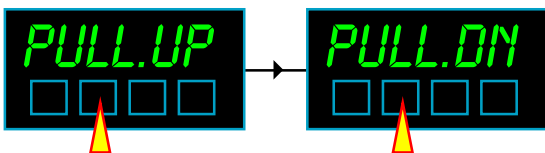
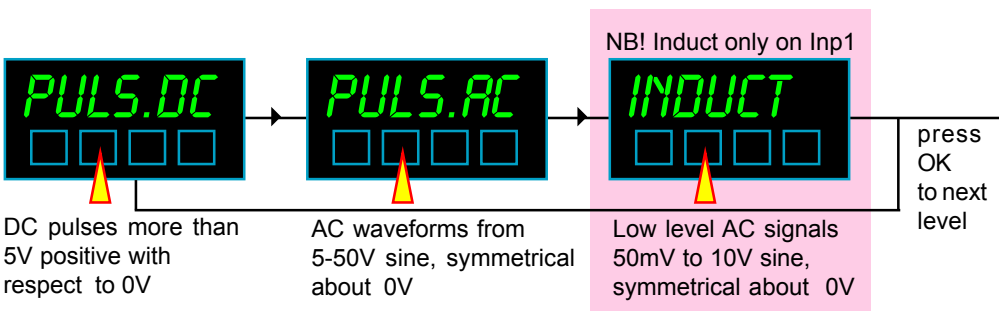
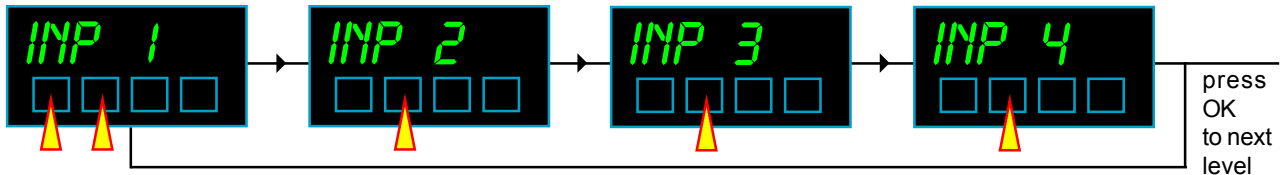

Pull-up = 47kilohm from signal input to +Excitation
 Pull-down = 47kilohm from signal input to 0V

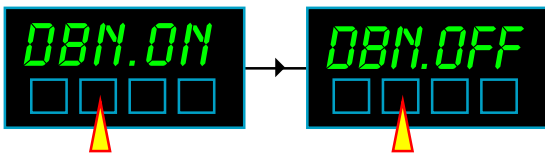

Hardware debounce with RC network.
 Approx. 1/20 Second time constant.

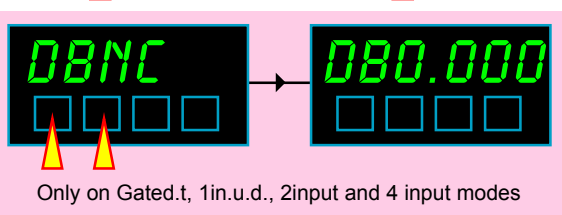

SLOW Software debounce for very slow signals.
 Set from 0.000 to 9.999 seconds. For example, if you set 5.000, then pulses following each other by less than a 5 seconds interval will be ignored.

You MUST disable the Slow software debounce if your input signal is higher than 1kHz.



To enable or disable it, press the right hand 2 buttons briefly in normal running mode, with the lockout switch off. Press OK to select P.DBNC.X and choose P.DBNC.1 to enable or P.DBNC.0 to disable the slow software debounce.

Signal Input type	Use these Settings			
NPN	PulsDC	Pull.Up	DBN.OFF	dbnc dbx.xxx
PNP	PulsDC	Pull.Dn	DBN.OFF	dbnc dbx.xxx
Contact closure	PulsDC	Pull.Up	DBN.ON	dbnc dbx.xxx
24V DC	PulsDC	Pull.Dn	DBN OFF	dbnc dbx.xxx
Passive Inductive pickup*	Induct	Pull.Dn	DBN.ON	dbnc dbx.xxx
AC voltage 5V up to 50V	PulsAC	PullDn	DBN.OFF	dbnc dbx.xxx

* Only available on input 1

Only on Gated.t, 1in.u.d., 2input and 4 input modes

How to install option boards



Where the product is intended for "UL" installations removal or addition of option boards is not permitted.



Warning: Disconnect all power before exposing the rear of the meter

If you want to open your meter to install or modify option boards, follow these steps...

- 1) Switch off power to the meter and unplug all connectors.
- 2) Unclip the front bezel. This is easier if you squeeze the top and bottom of the case, near the front.
- 3) Remove the small screws shown in the diagram. If the meter doesn't yet have an output option board, the top screw may not yet be fitted.
- 4) Slide the electronic boards out through the front of the case. You can easily separate the upper option board from the main board. We strongly suggest that you use anti-static precautions to prevent damage to the semiconductors.

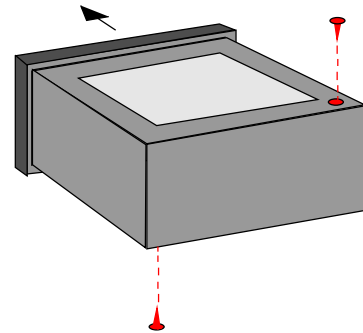

The board assemblies will look something like this...

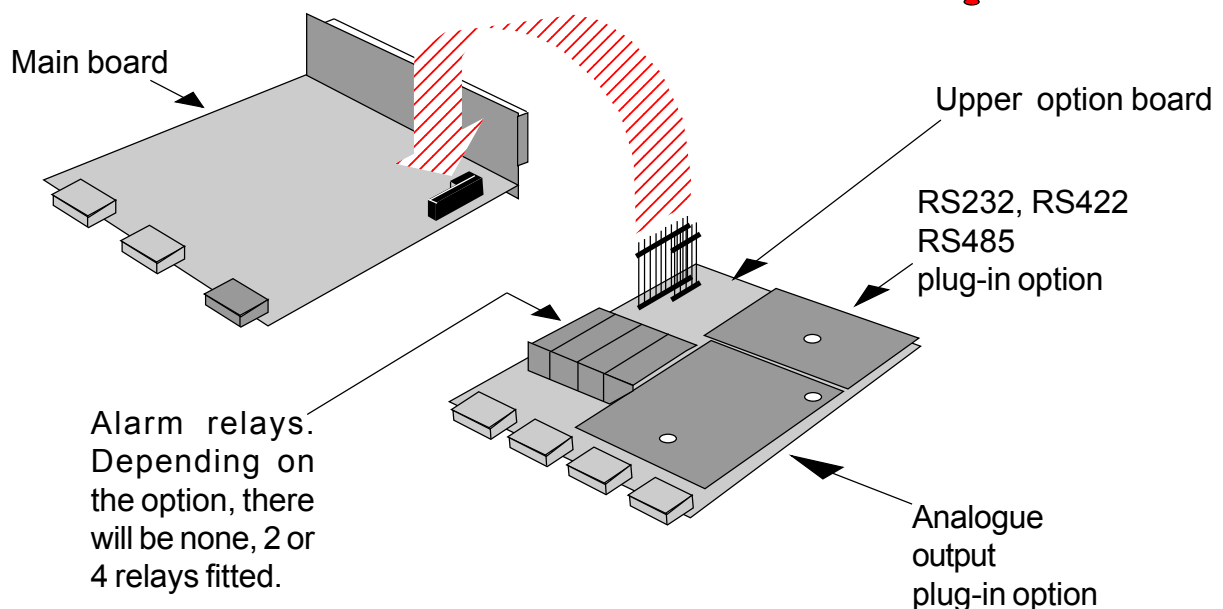

The analogue output and RS232 or RS422 plug-in option boards are fixed to the upper option board with white plastic pillars. You must apply a firm force when fitting or removing these options.

Always be careful to connect the pins to sockets accurately. When reassembling, make sure option boards are firmly fixed to the upper option board. When the boards are replaced in the case, secure them again with the two small black screws.

Analogue Output - page 1



Where the product is intended for “UL” installations removal or addition of option boards is not permitted.



Warning: Disconnect all power before exposing the rear of the meter

The analogue output board plugs onto the 0, 2 or 4 alarm upper option board.

It plugs onto a pair of connectors and is secured by two snap-pillars.

Check that the unit is set for voltage or current output, to suit your application.

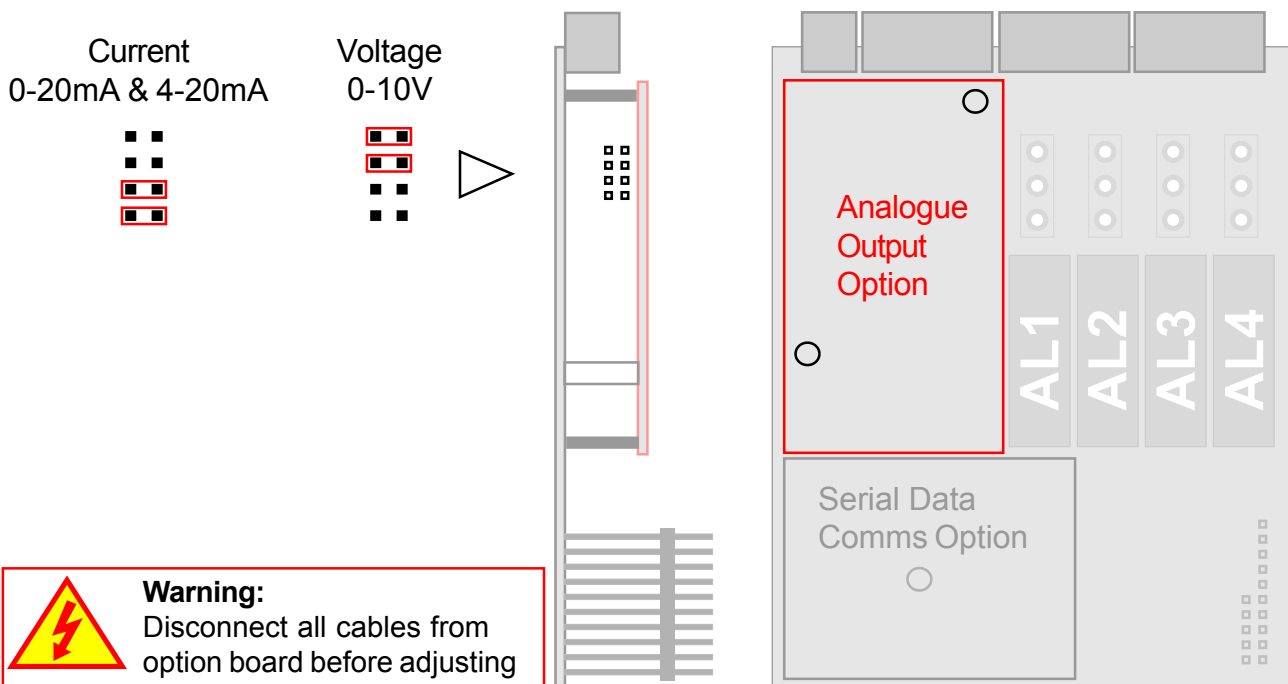

Re-assemble the meter, apply power and follow the Analogue Output Settings procedure on the next page.

You can set the analogue output to operate over a display range of your choice, to create 0-20mA, 4-20mA or 0-10V, fully isolated.

Please see the following page for a guide how to do this.

Handy Feature

You can tell if an analogue output is fitted to your meter, and if it has been set for voltage or current, by viewing the ‘Summary’ display.

To see this, press the two outer buttons of the display for 3 seconds. You will also see the summary when you first switch on your meter.

Analogue Output - page 2

Lockout notes: Cal Lock switch = OFF when changing. Switch Cal Lock to ON after changing

Your analogue output can cover 0-100% of its range over a display range which you can set.

For example, you might want 4-20mA output, for a display range of 500 to 1000.

You would press the Analogue O/P button for 3 seconds, and select 4-20mA

Then set 0% = 500

Then set 100% = 1000

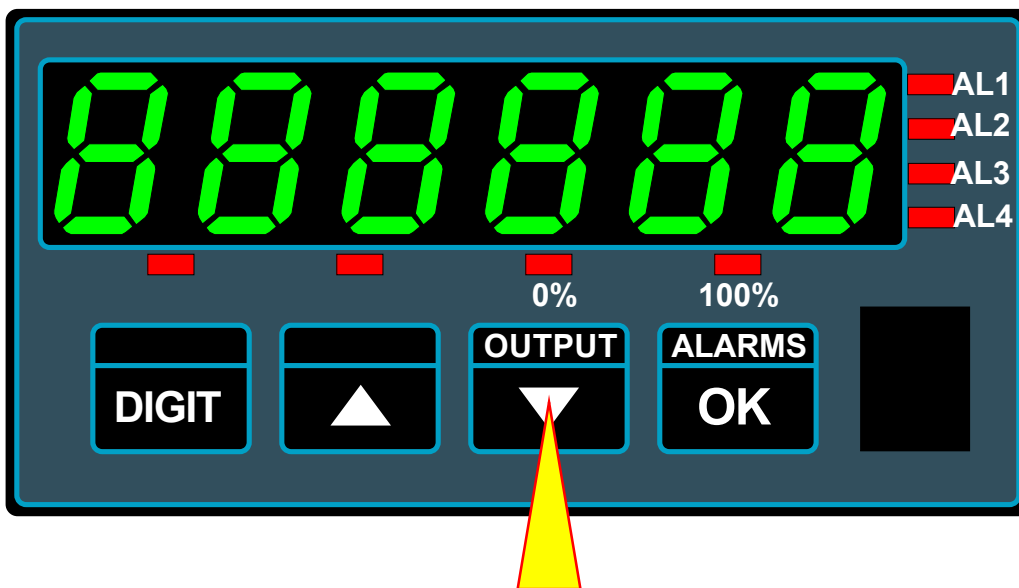

Press the OUTPUT button for 3 seconds. If an output board is fitted, the display will confirm this and confirm the range chosen by the jumpers on the previous page.

The 0% LED will flash. Select the Output range you want.

Use the **DIGIT**, ▲ and ▼ buttons to set the display value at which you want 0% analogue output.

Press **OK** when done.

The 100% LED will flash.

Use the **DIGIT**, ▲ and ▼ buttons to set the display value at which you want 100% analogue output.

Press **OK** when done.

When you have finished setting the meter, put the lockout switch in its ON position now, to prevent your settings from being changed.

Alarm Board Configuration



Where the product is intended for "UL" installations removal or addition of option boards is not permitted.



Warning: Disconnect all power before exposing the rear of the meter

You can have 3 types of alarm board:-

- An alarm board with no relays, which will simply allow you to fit analogue and/or serial output options.
- An alarm board with 2 relays, to which you can also fit analogue and/or serial output options.
- An alarm board with 4 relays, to which you can also fit analogue and/or serial output options.

For failsafe operation (where contacts open on alarm or when power is lost to the meter) set the jumpers for OPEN CONTACTS as shown below, and DE-ENERGISE on alarm, in the alarm setup menu. To access the alarm board, remove power from meter, including any power which might be on the alarm output board.

Look on the top and bottom surfaces of the case, near the rear. You will see two small screws, one on each surface. Remove both screws. Now, clip off the front bezel and slide the meter assembly carefully out via the front of the case. The relay board plugs into the main board. Gently separate the two boards.



Warning: Disconnect all cables from option board before adjusting



Warning: All switched power must come from the same phase.

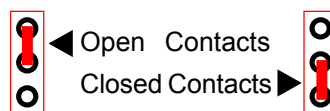
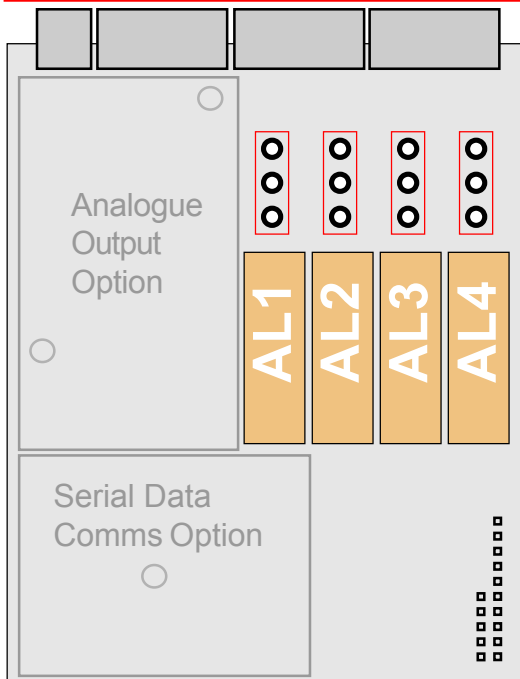

Select relay output contact status, when relays are de-energised (power removed from meter) by placing these jumpers. Each relay has a snubbing network to minimise contact sparking.

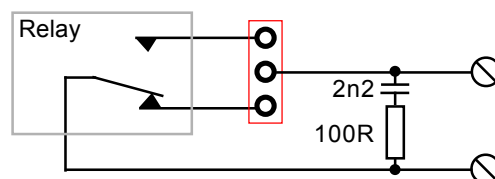

When you have set the jumpers, refit the board to the meter and carefully slide the assembly back into the case.

Fit the two small screws to the top and bottom surfaces of the case.

Alarm Programming

Lockout notes: Alarm Lock switch = OFF when changing. Switch Alarm Lock to ON after changing

Alarm lockout switch must be OFF. Press alarm button briefly to choose an alarm channel - look at the AL1, AL2, AL3 or AL4 leds to see which channel is selected.

Then press the alarm button for 3 seconds to show the Setpoint window - you can now edit the setpoint value with the DIGIT, UP and DOWN buttons. Press OK when done.

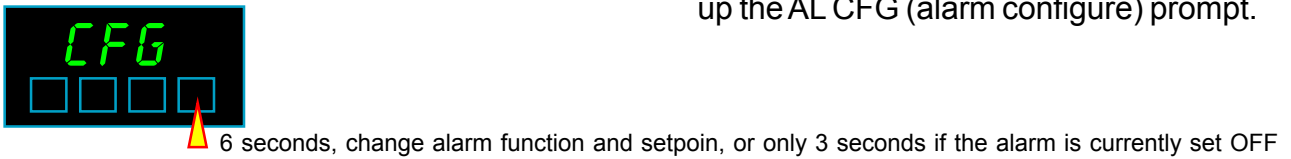
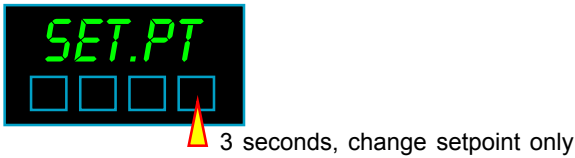

If you want to change the function of an alarm channel, keep your finger on the alarm button for a further 3 seconds after you see the Set.pt prompt, which will bring up the AL CFG (alarm configure) prompt.

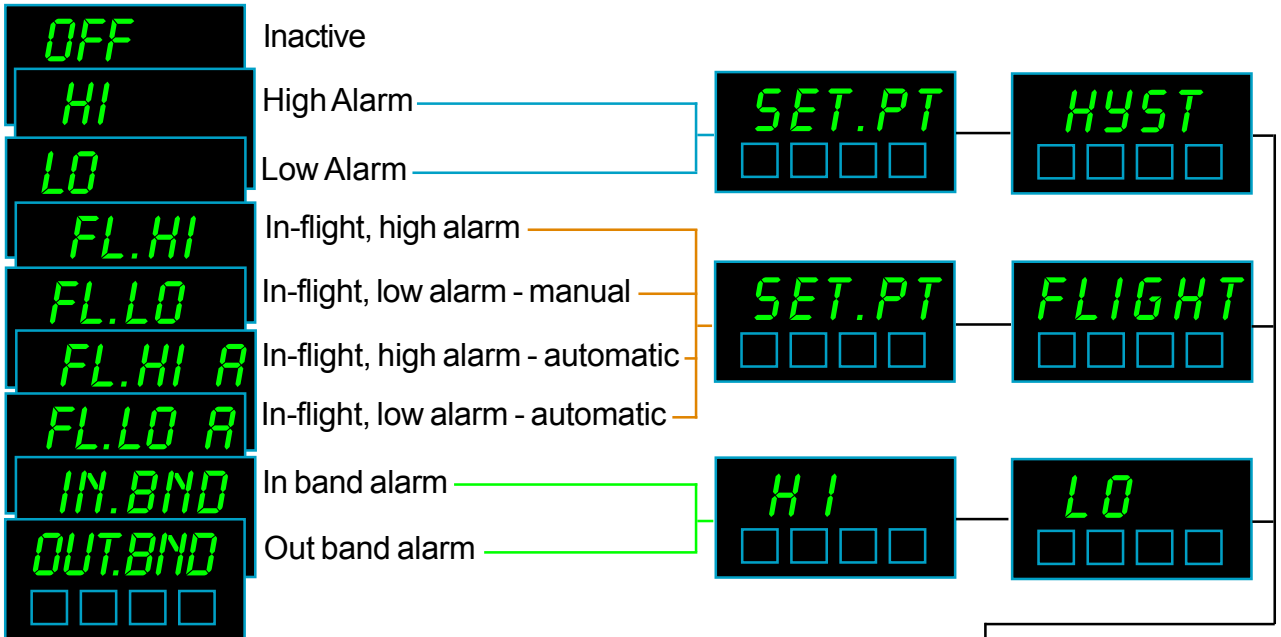

rLY dE
(Relay will De Energise on trip = Failsafe)

rLY En
(Relay will Energise on trip = non-failsafe)



See the alarm board configuration page also, for details on selecting normally open or normally closed contact outputs.

See the following pages for more detailed descriptions of how each alarm mode operates. Remember to put the alarm lock switch ON when finished, to keep your settings safe.

Hi Alarm relay action, no Hysteresis

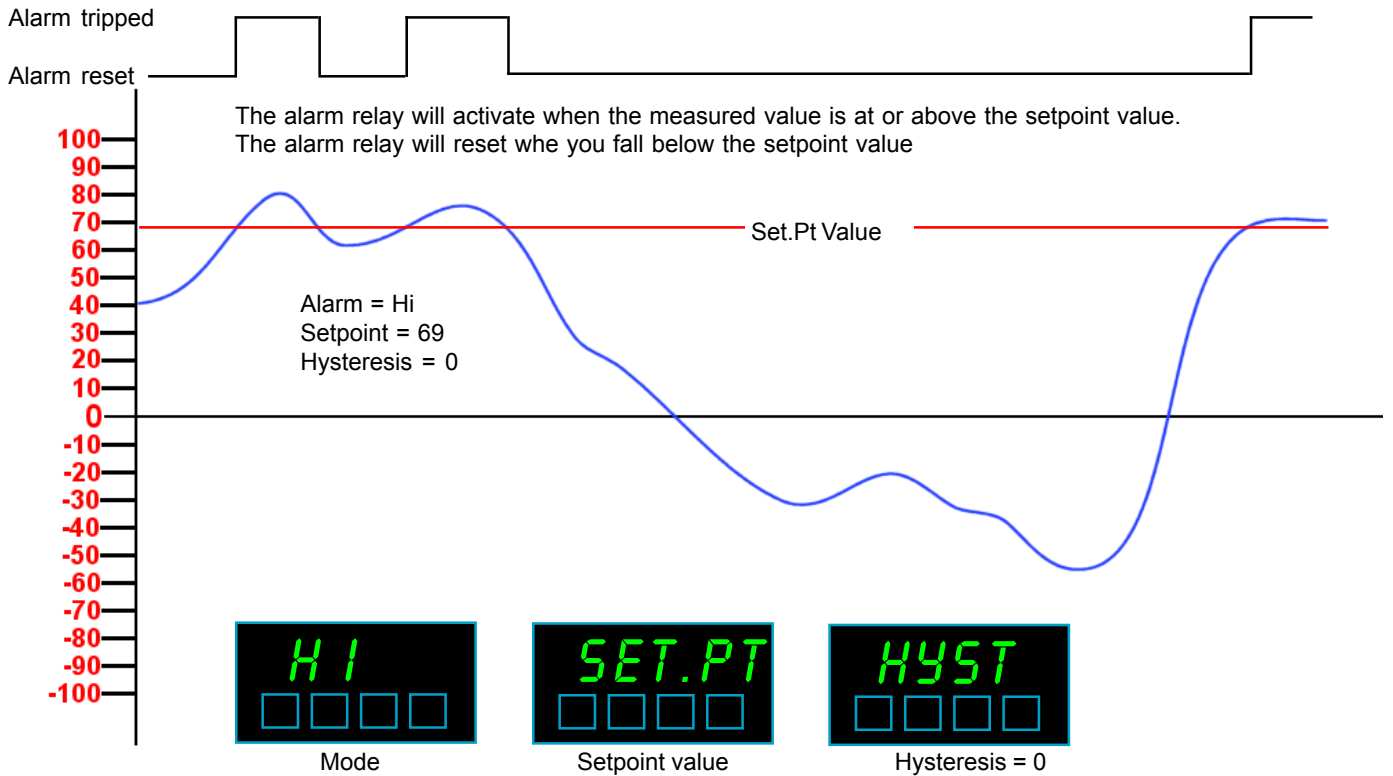

Hi Alarm relay action with Hysteresis

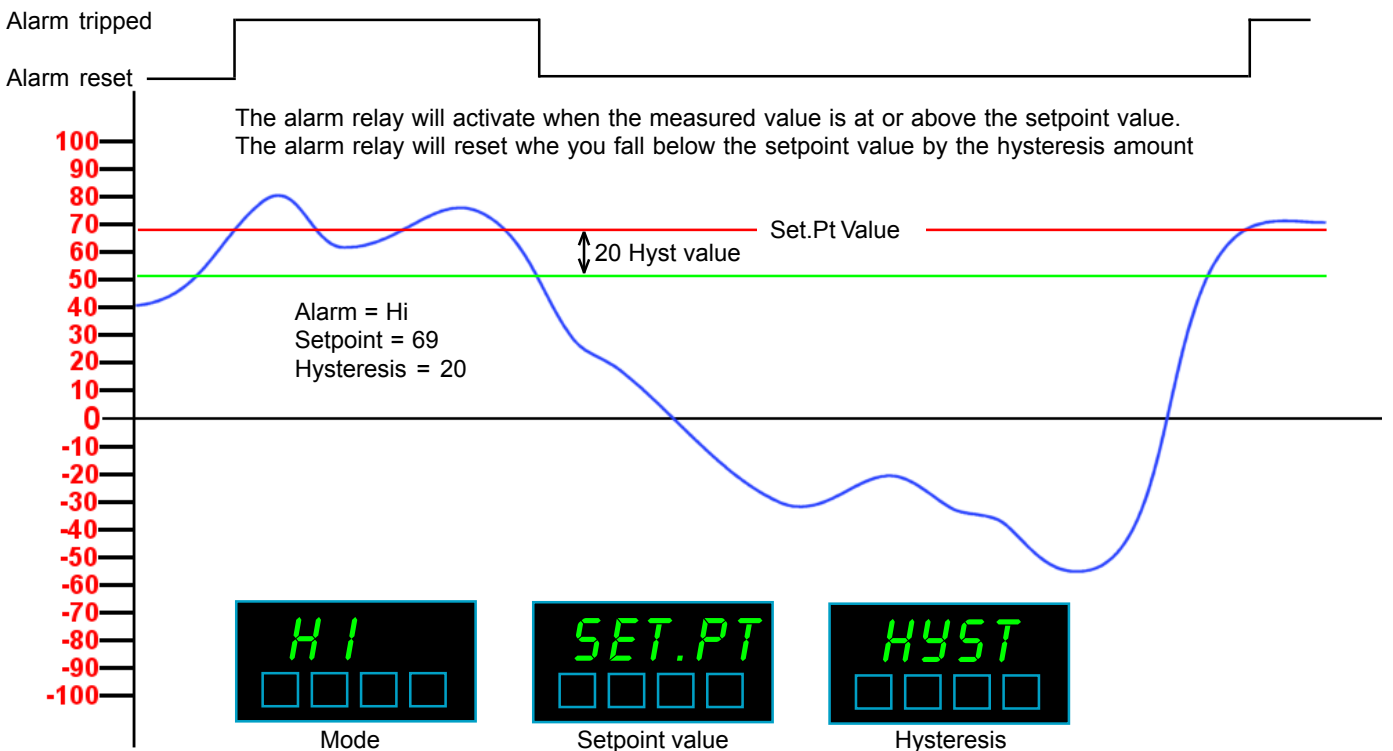

Lo Alarm relay action, no hysteresis

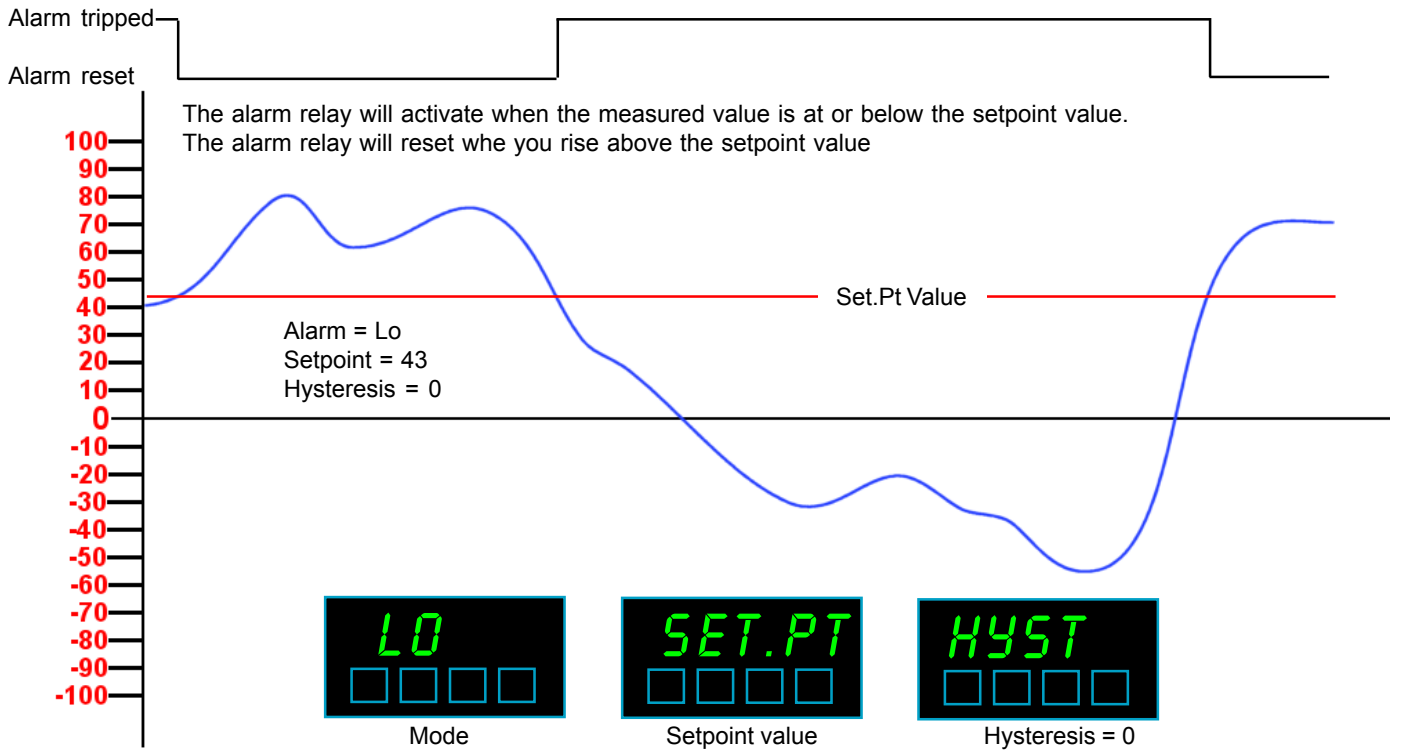

Lo Alarm relay action with Hysteresis

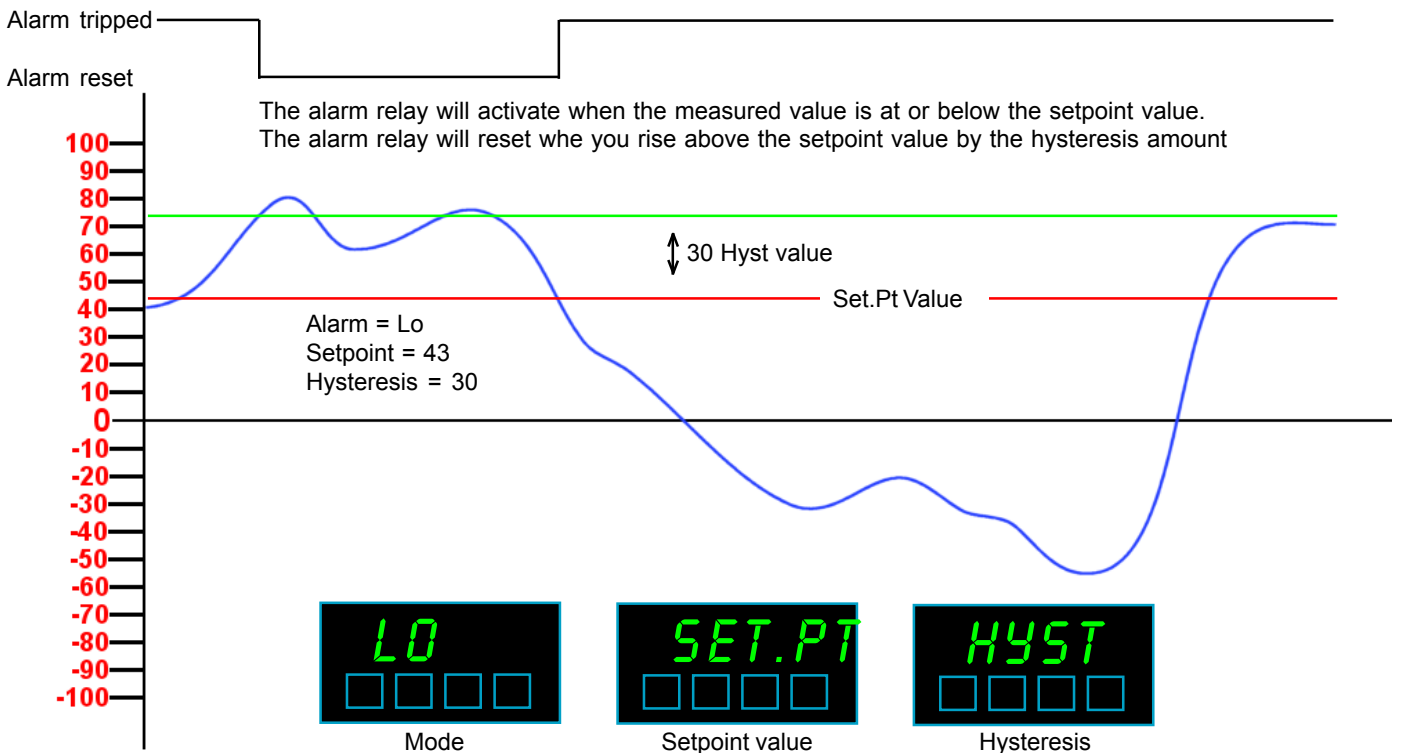

InFlight Hi Alarm relay

The In-Flight alarm modes are used in applications where you want to accurately fill one container from another.

If you were to simply close the shutoff valve when the weight reaches your desired amount, you would find that the weight is higher than you'd hoped for.

This is because some material is still in mid-flight when you send the alarm signal to shut the valve, and the valve will take some time to fully close.

The load measured on the loadcell platform will continue to increase after the alarm signal is sent to the shutoff valve.

The InFlight modes subtract or add this "In-Flight" amount from the setpoint to ensure that your final fill amount is as close as possible to your desired value.

In automatic mode, the unit will note the error after the first fill and try to correct for it on the next fill by moving the trip point by all the error amount on the 2nd fill and by half the subsequent error amount on each following fill. It will constantly monitor the error and correct by half that amount, to ensure a smooth trend towards accurate filling.

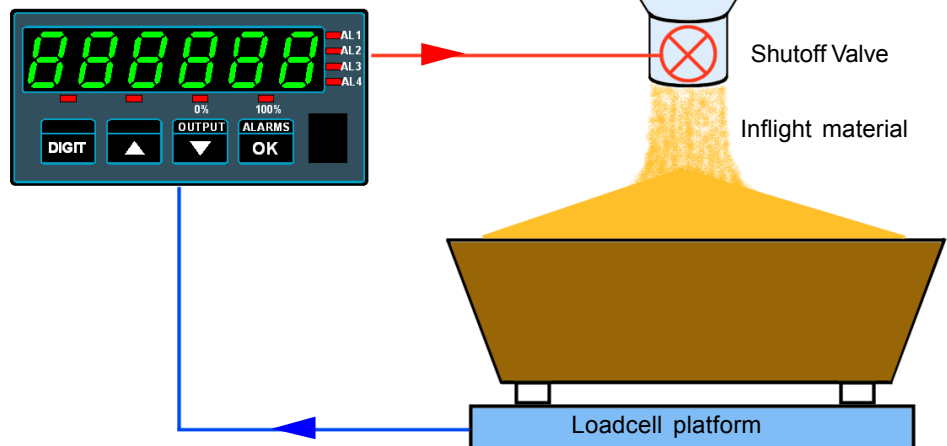
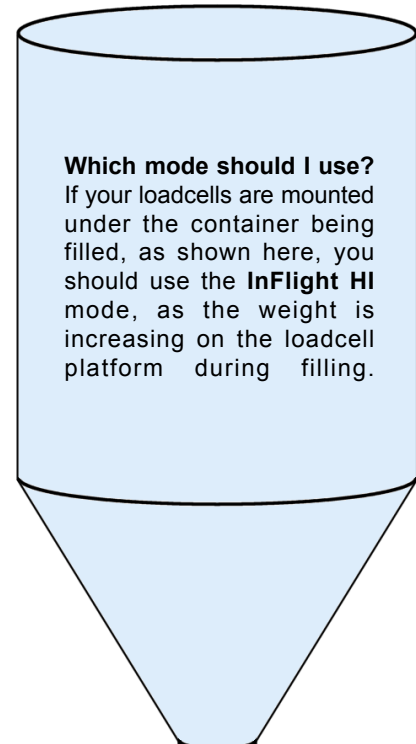

Manual or Automatic ?

You can set a manual value for the Inflight amount, if you know how much in-flight material will continue to fall into the container after the shutoff valve has been triggered, and if this value is likely to remain consistent from fill to fill.

If you don't know the inflight amount or if the material flow properties may change from batch to batch, you can use the automatic mode.

To set, press the alarm button until you illuminate the alarm LED channel you want to change. Press the alarm button again for around 6 seconds, you will see "Set.Pt" followed by "AL CFG". Use the Digit, UP/Down buttons and OK to set.

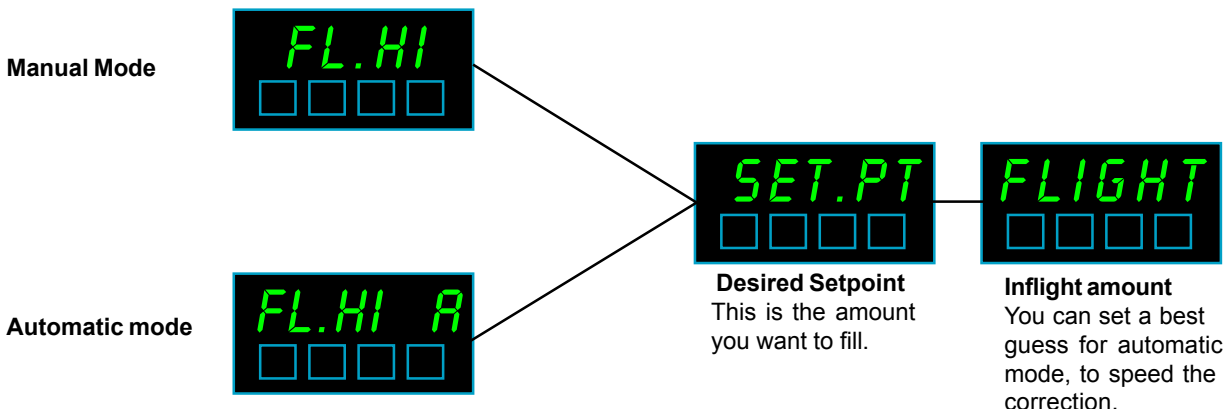

InFlight Lo Alarm relay

The In-Flight alarm modes are used in applications where you want to accurately fill one container from another.

If you were to simply close the shutoff valve when the weight reaches your desired amount, you would find that the weight is higher than you'd hoped for.

This is because some material is still in mid-flight when you send the alarm signal to shut the valve, and the valve will take some time to fully close.

The load measured on the loadcell platform will continue to increase after the alarm signal is sent to the shutoff valve.

The InFlight modes subtract or add this "In-Flight" amount from the setpoint to ensure that your final fill amount is as close as possible to your desired value.

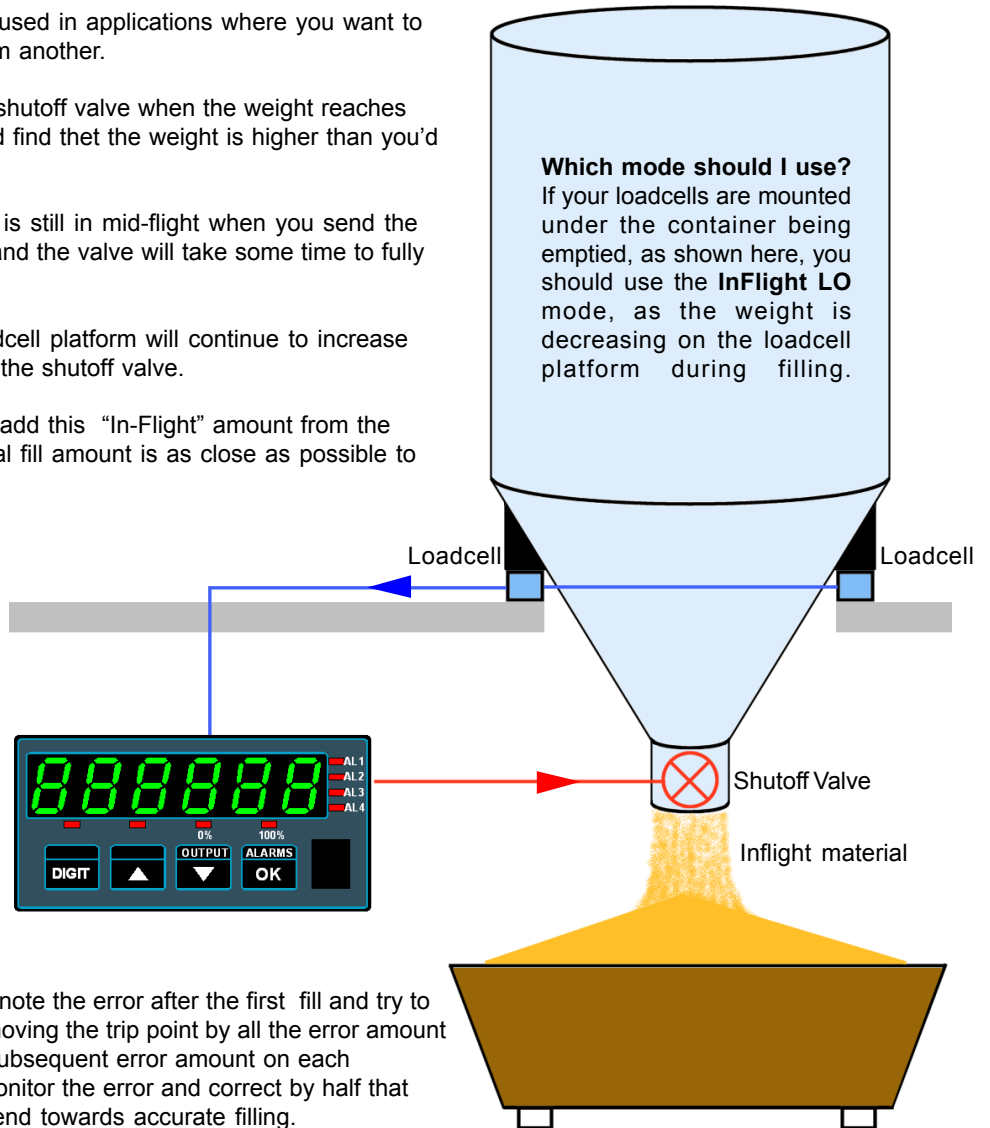

In automatic mode, the unit will note the error after the first fill and try to correct for it on the next fill by moving the trip point by all the error amount on the 2nd fill and by half the subsequent error amount on each following fill. It will constantly monitor the error and correct by half that amount, to ensure a smooth trend towards accurate filling.

Manual or Automatic ?

You can set a manual value for the Inflight amount, if you know how much in-flight material will continue to fall into the container after the shutoff valve has been triggered, and if this value is likely to remain consistent from fill to fill.

If you don't know the inflight amount or if the material flow properties may change from batch to batch, you can use the automatic mode.

To set, press the alarm button until you illuminate the alarm LED channel you want to change. Press the alarm button again for around 6 seconds, you will see "Set.Pt" followed by "AL CFG". Use the Digit, UP/Down buttons and OK to set.

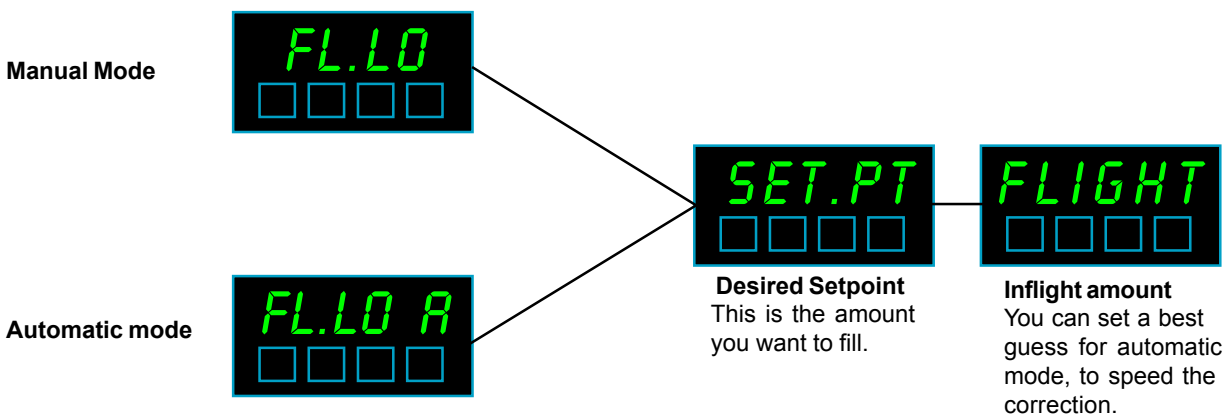

In-Band Alarm relay

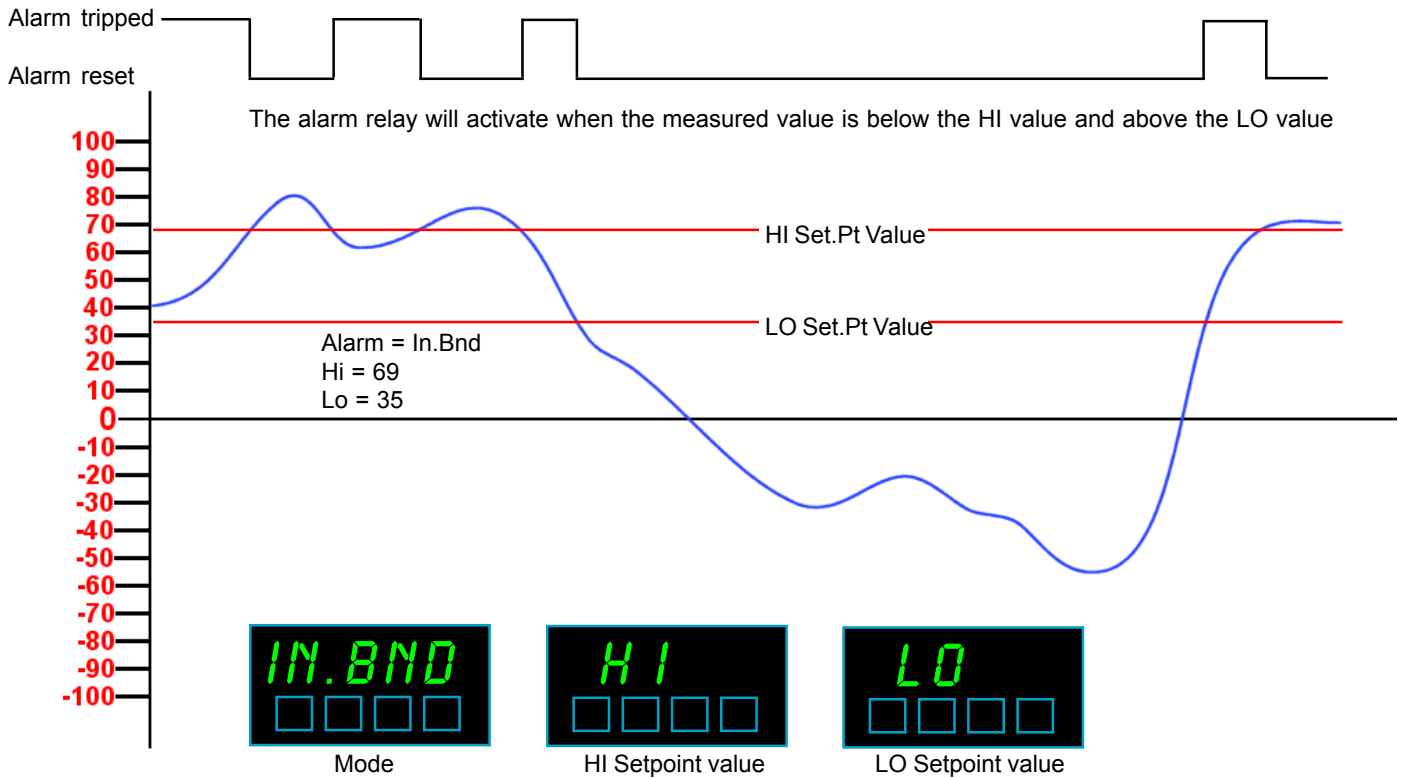

Out-Band Alarm relay

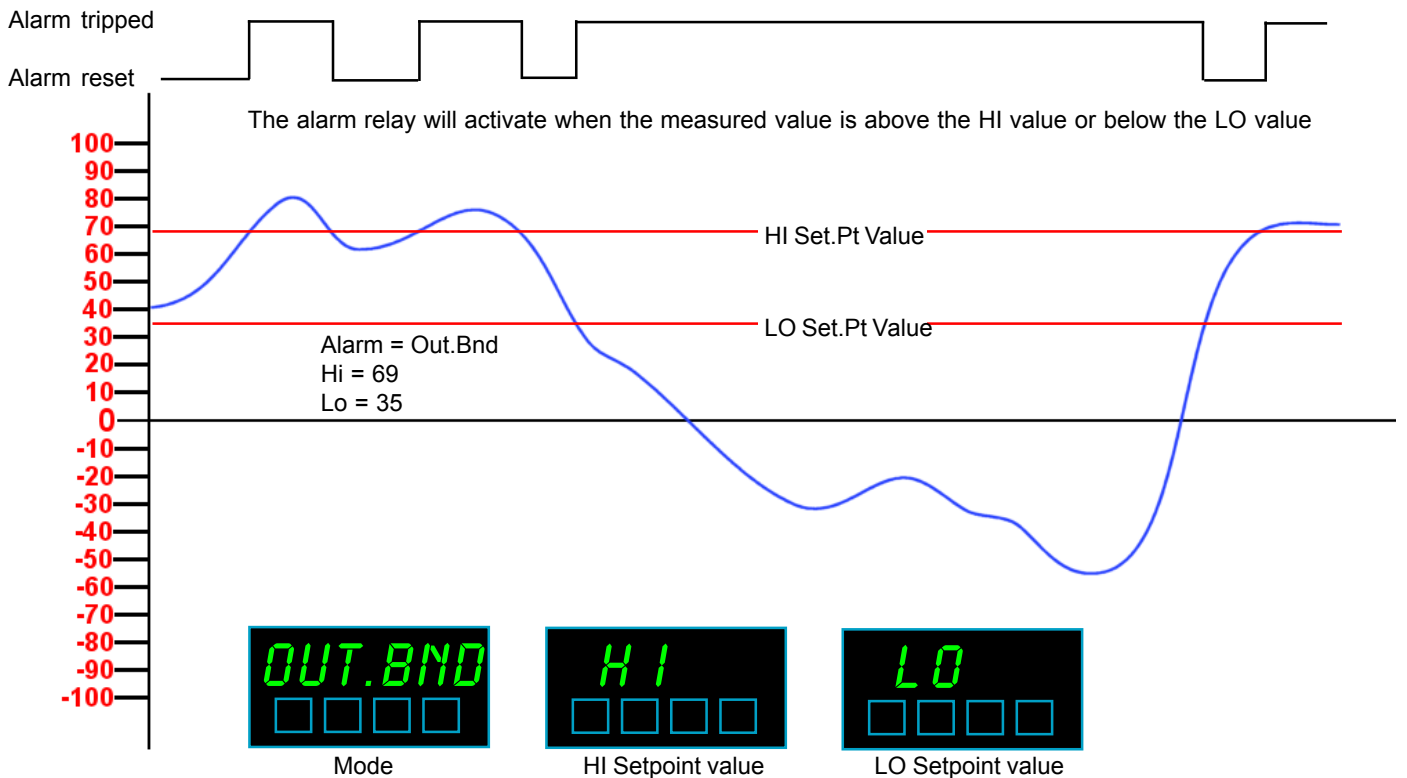

Serial Output - page 1



Where the product is intended for "UL" installations removal or addition of option boards is not permitted.



Warning: Disconnect all power before exposing the rear of the meter

The serial output board plugs onto the 0, 2 or 4 alarm upper option board.

It plugs onto a pair of connectors and is secured by a snap-pillar.

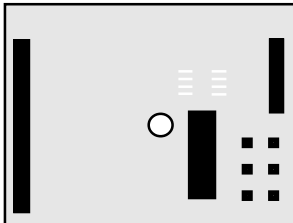

RS232 board
No jumpers needed

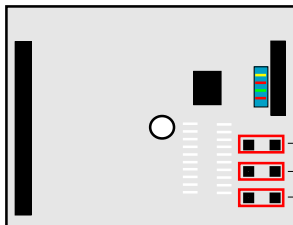

RS485 board
If fitted, connects 120 Ohm terminator
If fitted, sets a bias of +0V on Sig A
If fitted, sets a bias of +5V on Sig B

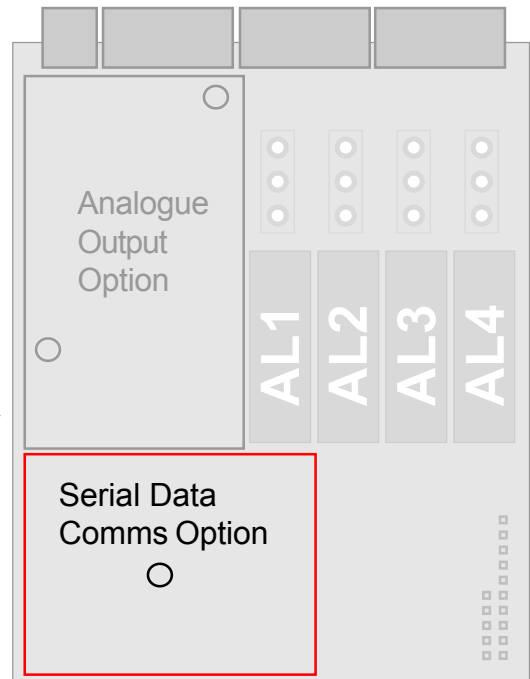

Warning:
Disconnect all cables from option board before adjusting

Typical UART output

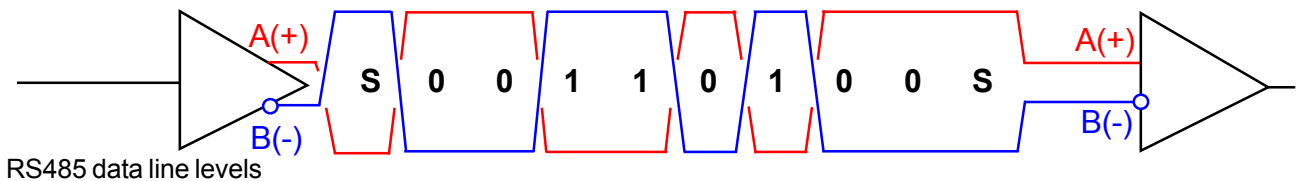
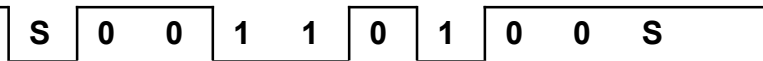

The 120 Ohm termination resistor should be fitted to only the last display on an RS485 data link, to improve noise immunity. A terminator should also be fitted on the sending device.

The bias jumpers are not normally fitted, but are available if your system needs biasing, to keep it in a valid idle state when data is not present.

Re-assemble the meter, apply power and follow the Serial Output Settings procedure on the next page.

Handy Feature

You can tell if a serial output is fitted to your meter by viewing the 'Summary' display. Press the two outer buttons of the display for 3 seconds. You will also see the summary when you first switch on your meter.

Serial Output - page 2

Lockout notes: Cal Lock switch = OFF when changing. Switch Cal Lock to ON after changing

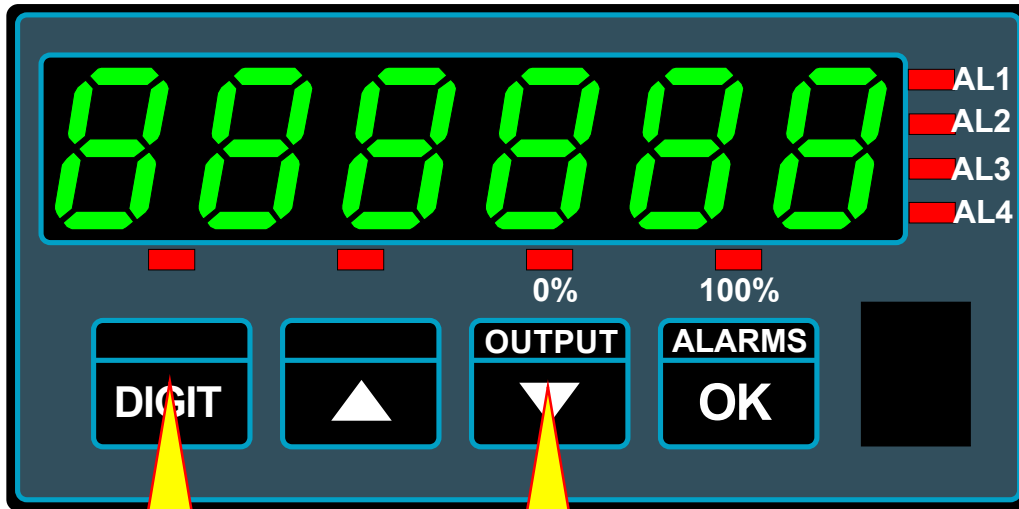

Briefly press together

Baud :- Select from 300,600,1200,2400,4800,9600,19200,38400, 57600,115200

dF = Data Format = 8n1, 7n1, 7E1, 7O1

Prot = Protocol = P1 (polled ASCII), P2 (Polled Modbus ASCII), C1 (Continuous), H1 (GPS)

Addr = Address = 00 to FF

t.rEP = Reply Delay time in milliseconds 00 to 99

t.Chr = Character space timing in milliseconds 00 to 99

Protocol C1 – Continuous output

Meter sends: 8 characters<CR>

e.g.

20 20 20 20 20 2D 31 37 0D	(-17) decimal position = 0
20 20 20 20 20 2D 31 2E 36 0D	(-1.6) negative value
20 20 20 20 20 31 2E 38 0D	(+1.8) positive value
20 20 20 20 20 20 4F 52 0D	(OR) over range
20 20 20 20 20 20 55 52 0D	(UR) under range

Protocol H1 - GPS clock data format for use with our ASR-GPS

Protocol P1 – Polled ASCII

Controller sends: <STX> ADDRH:ADDRL r <ETX> e.g. 02 46 37 72 03 (to device F7)

Meter replies <STX> 8 characters <ETX>

e.g.

02 20 20 20 20 20 2D 31 37 03	(-17) decimal position = 0
02 20 20 20 20 20 2D 31 2E 36 03	(-1.6) negative value
02 20 20 20 20 20 31 2E 38 03	(+1.8) positive value
02 20 20 20 20 20 20 4F 52 03	(OR) over range
02 20 20 20 20 20 20 55 52 03	(UR) under range

Protocol P2 – Polled ASCII Modbus

When you have finished setting the meter, put the lockout switch in its ON position now, to prevent your settings from being changed.

Logic Inputs and extra button functions



Warning:
Disconnect all power before exposing the rear of the meter



Warning:
Logic inputs are NOT isolated from input signal

Lockout notes: Cal Lock switch must be ON to enable logic inputs.

Peak and Valley Detection (Maximum/Minimum Reading View)

The meter can store the lowest and highest reading values in memory. You can see these values if you press the MAX/MIN front panel button, or by using remote contact closure switches. The first press shows peak, with the upper left hand indicator bar lit (marked 'Max.'). The second press shows valley, with the lower left hand indicator lit (marked 'Min.'). The display returns to the running value after 2 or 3 seconds. To reset the memory, press the RESET button for more than 3 seconds while peak or valley is being displayed. Peak and Valley values are not stored if you switch the meter off.

How to use the MAX/MIN button to view Peak or Valley

- 1) Link terminal 7 to terminal 9
- 2) Set lockout switch 'ON'
- 3) Press UP arrow key (MAX/MIN) for peak, valley, normal

Remote contact closure viewing of Peak/Valley

- 1) Connect a normally-open contact closure switch between terminals 7 and 9
- 2) Set the calibration lockout switch 'ON'

Reset Command

The reset command clears any stored peak or valley data, any tared offsets and any in-flight compensation data. It may be accessed either from the front panel or by external contact closure command.

Front Panel key reset command

- 1) Link terminal 7 to terminal 10 (not necessary if MEM-08 option fitted)
- 2) Set calibration lockout switch 'ON'
- 3) Press Down Arrow key to reset display.

For Tare reset, you must press the Tare button AND the Reset button together.

For Peak/Valley reset, you must activate the reset key while a peak or valley value is being displayed.

Remote contact closure resetting

- 1) Connect a normally-open contact closure switch between terminals 7 and 10
- 2) Set calibration lockout switch 3 'ON'

Calibration Counter / Tamper detector

An internal totaliser counts each calibration. The 'CAL XXX' value appears for a second or two after you switch the meter on. The number starts at 00 and can go up to FFF. It counts all changes made to the meter's calibration. It stores the total in non-volatile memory which can't be reset, so is useful for keeping track of the meter's calibration history. You can ask the meter to repeat its summary at any time if you press the two outer buttons for 3 seconds.

Notes

Reverse/Mirror/Heads-Up display

The INT2 display can be 'mirror-imaged' to allow it to be viewed as a reflection in a rear-view mirror, windscreen or other reflective surface.

This can be useful for creating 'heads-up' displays, for some test installations where the display will be viewed in a mirror, as a display for drivers reversing large vehicles, etc.

Reverse / Mirror display

Press both buttons briefly, press OK 5x

Change with UP/DOWN button. OK=Accept



Calibration lockout OFF

Choose Rev.d 0 for normal display

Choose Rev.d 1 for reflected display

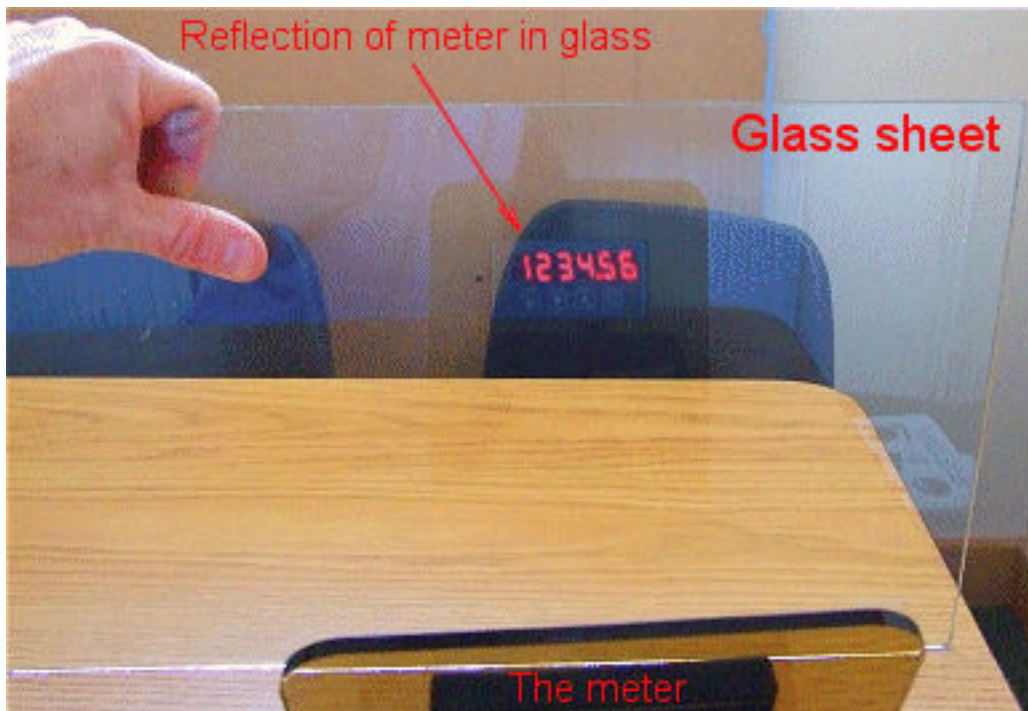

Equipment Specifications

Bezel size	48mm high by 96 mm wide (1/8 DIN)
Panel Cutout	45 mm high by 92 mm wide
Case Depth	125 mm including connectors
Weight	300 grammes
Case Material	Black polycarbonate
Connectors	Detachable Screw Terminal connectors
Environmental	Storage Temperature range -20 to +70C, non condensing Operating temperature range 0 to 50C, non condensing Front sealed IP65.
Power Burden	100-240 VAC, 45 to 60Hz or 11-30 VDC optional 10VA maximum
Input Signals (4x)	Contact closures, with debounce NPN and PNP proximity sensors (47kilohm pullup/down) 24V logic pulses from PLCs AC tachometer inputs 100mV passive Inductance pickup (on Input 1 only)
Frequency Range	0-40,000 Hz (0-100,000Hz on Rate only)
Accuracy	+/-0.05% of range, quartz crystal reference
Span tempco	20 ppm/Degree Celsius
Excitation voltage	24VDC nominal rated at 60mA, to power sensors
Averaging / smoothing Memory	Selectable averaging time constant of 0 to 25 seconds. Totals and settings saved in 10 year non-volatile memory.
Display update rate	3 readings per second.
Display Range (max)	-199999 to 999999
Plug-In Output Options	
Analogue O/P	0-10VDC 0-20mA 4-20mA
Drive capacity	>1K Ohms <500 Ohms <500 Ohms
Isolation	250 VAC Optically isolated
Accuracy	+/-0.1% range, +/-10mV for ANV, +/-10uA for ANI, 50ppm/C stab.
Linearity	+/-0.02% of range
Resolution	better than 0.2mV for 10v, 0.4uA for 20mA range
Scaling	Fully adjustable, direct or inverse
Alarm Relay O/P	2 or 4 alarms SPST rated 2 Amperes at 250 VAC, resistive load. All relays must switch power from the same phase. Selectable normally open or normally closed by on-board switches. Selectable energise or de-energise on trip by menu Independant hysteresis on each alarm relay.
ASCII Data O/P	RS232 or RS485 ASCII Value of reading.
Format	1 start bit, 8 data, no parity. <Measurement><CR>
Isolation	250 VAC optically isolated

Record of revisions

1 May 2007	INT-L Released with F00.001 software
22 May 2007	Added RS485 logic level diagram
22 August 2007	Added Zener barrier application notes.
2 October 2007	F00.006 software. Linearisation added. Inflight compensation and band alarms added. Brightness setting added, Menu timeout delay added.
6 May 2008	Added 'General Description' page. Added power frequency spec. Mounting & Installation page added. Wiring Advice page added
27 May 2008	Added UL label sample to front page. Added ClassII connection details.
26 June 2008	Added Bootup option menu
28 October 2008	Software version 12 released. Includes mirror display option, software debounce option.
13 Nov. 2008	Amended VA ratings and added UL listed graphic
21 Nov 2008	Version 14 software released, upgrading version 12 (no version 13). Corrects reset bug on totaliser and variable brightness bug.
9 Dec 2008	Added cULus fuse recommendations, removed front panel programming port reference
15 Dec 2008	Added warning to option pages that no options shall be added or removed where the product is intended for UL installations
30 June 2009	Address updated

Waste Electrical and Electronic Equipment (WEEE)

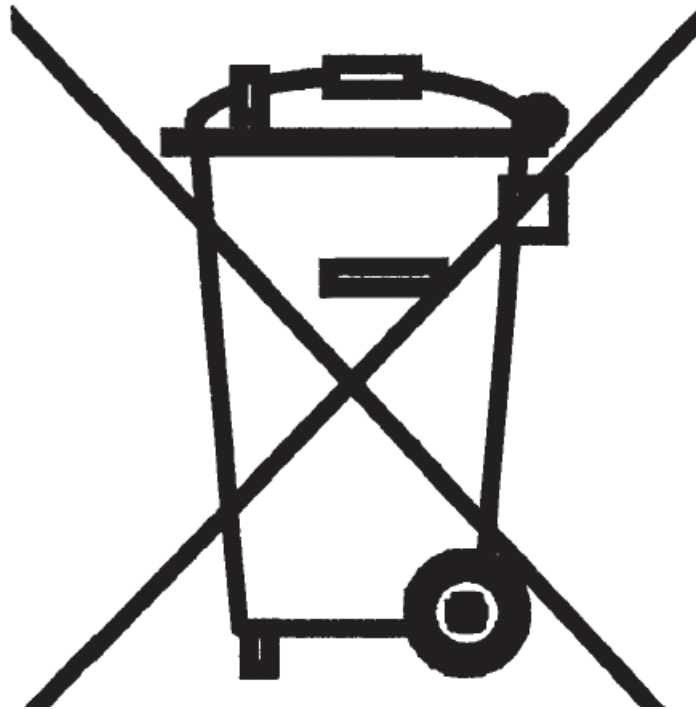

In Europe, this equipment must be disposed of in accordance with European Parliamentary Directive 2002/96/EC

This directive encourages recycling and the reduction of waste materials in the environment.

This means it must be sent to an approved recycling plant if you want to dispose of it.

It must not be thrown away in general rubbish.

If you are unable to dispose of this item locally, you may send it to us for recycling.

Conditions:

1. We will only accept items of our manufacture.
2. You must pay for the transport of the goods to us.
3. We will only accept items if they include a signed declaration by an authorised person in your organisation, stating that :-
 - i. The item is safe to handle and has no contaminants which may be harmful to health.
 - ii. You wish us to dispose of or destroy the item(s)

Notes

Notes

Declaration of Conformity

Declaration Reference : INTUITIVE Mk2
Issue Date : 30 April 2007
Products Covered : INTUITIVE Mk2 series
Title : DOC-INTUITIVE2

This is to confirm that the Product covered by this declaration have been designed and manufactured to meet the limits of the following EMC Standard :

EN61326-1:1997

and has been designed to meet the applicable sections of the following safety standards

EN61010-1:2001

Conditions

The meters are permitted a worst case error of 1% of A/D range during electro-magnetic disturbance, and must recover automatically when disturbance ceases without the need for human intervention, such as resetting, power-down etc.

The meters covered by this certificate must be installed in adherence to the following conditions :-

Signal cabling shall be routed separately to power carrying cabling (includes relay output wiring)
All signal cabling shall be screened. The screen shall only be terminated to the power earth terminal

Declared as true and correct, for and on behalf of London Electronics Ltd.

J.R.Lees Director