

London Electronics Limited

Warren Court, Chicksands, Shefford, Beds. SG17 5QB

Tel.: 01462-850967 Fax.:01462-850968

E17XX Series of Large Displays **Elapsed Timers**

NPN, PNP, Contact Closure, TTL, CMOS logic Inputs
Including Sensor Excitation and RS422 Data Output

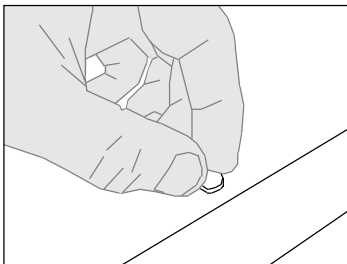
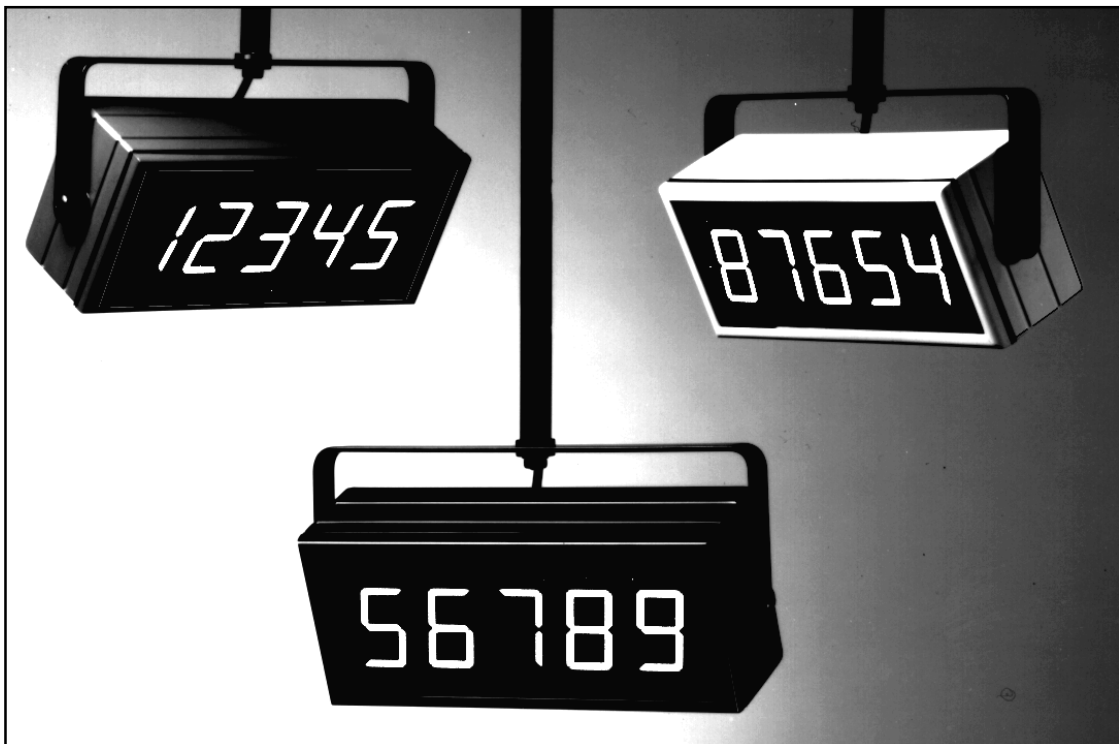

Rear case screws - please note

The rear panel is held in place with finger-screws, which only need to be gently tightened. **Do not use tools to tighten or loosen the screws, as this could cause damage to the internal threads.**

User Manual

Rev.9.0 11 June 2004

Doc. E17XX.p65

CONTENTS.

SECTION	PAGE
INTRODUCTION.....	3
1.0 UNPACKING AND INSPECTION.....	4
2.0 GENERAL INFORMATION.....	4
2.1 General specifications.....	5
3.0 INTERNAL CABLES.....	6
3.1 Signal cables.....	6
3.2 Mains cables.....	6
4.0 DETAILED OPERATING INFORMATION	
4.1 Pulse I/P Selection.....	7
4.1.1 Jumper Functions and Positions.....	7
4.2 Typical Input connections.....	8
4.3 RS485 (optional) output notes.....	8
4.4 Contact Closure Remote Programmer connections.....	9
4.5 Programming your display.....	9
4.6 The Programming Menu & Brightness adjustment.....	10
4.7 Programming Flow Chart.....	11
4.8 Application Example.....	12
5.0 INSTALLATION.....	13
5.1 Mounting positions.....	14
5.2 Panel mounting.....	14
5.3 Wall mounting.....	14
5.4 Suspension mounting.....	14
5.5 Multiple display mounting.....	15
6.0 TROUBLE SHOOTING AND MAINTENANCE.....	15
7.0 SAFETY CONSIDERATIONS.. .....	15
8.0 WARRANTY.....	16
9.0 OTHER LONDON PRODUCTS.....	17
10.0 AND FINALLY.....	18

Elapsed Timer model - E17XX

INTRODUCTION

The E17XX is one member of a broad family of Large Displays. The family is the '1700 Series', and the part number tells you a little about the display's function.....

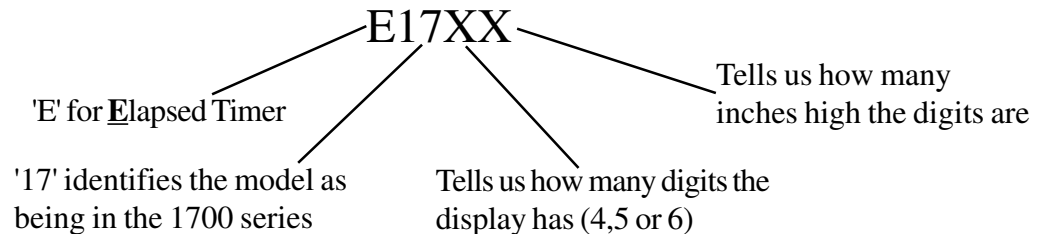

This model is intended for large time measurement display use. It accepts the most commonly encountered proximity sensors, of NPN or PNP type, contact closures, TTL and CMOS logic levels.

The incoming pulses can be used to start and stop the timer. A contact closure Reset input is available.

An optional RS422 output is available, useful for feeding remote mimic displays. If you require serial input only, and do not require pulse input, a simpler, model is available, S17XX series. The serial input models can have 4, 5, 6 or 7 digits.

The configuration settings and calibration constants of the display are stored in non-volatile E²PROM memory, which is retained for at least 10 years. Change to the settings is achieved by way of remote contact closure inputs, allowing alteration of the unit's configuration menu and brightness.

The case is sealed to IP65, and the lens is 4mm thick polycarbonate, making it ideal for use in food industry washdown applications.

1.0 UNPACKING AND INSPECTION

PLEASE check the carton's contents as soon as possible after receipt, to detect any transit damage or losses. Unpack the contents and check each item in the box against the check list below to make sure you have all items.

Check List :

- Handbook
- Display
- Mounting kit (where appropriate)
- Programming Unit (If Ordered)

In the event of damage, please contact the carrier and advise our sales office of the fault.

Please retain the carton packing material, for future possible use.

2.0 GENERAL INFORMATION

This handbook covers the Elapsed Timer model of the 1700 series large displays.

The 1700 series is a family of units for broadcasting process values and data on easy to read large 7 segment displays. Character heights of 2", 4" or 6" are standard, and, dependent on type, displays are 4,5,6 or 7 digit. Extra-large and Daylight viewing displays are available to special order.

The enclosures for the displays are of welded UPVC material with tough lenses, providing certified protection to IP65/66 for the internal electronics. Thermostatic heater options may be installed for outdoor mounting in cold climates.

Case colours are white or black.

The units incorporate a 95 to 265VAC power supply (Which can be used on DC in the range 100 to 300 VDC) for operation off any mains source without the need to re-configure.

Display brightness is settable to 4 levels to accommodate differing ambient light conditions and the 3 standard character heights provide a choice of viewing distances of up to 20, 40 and 60 metres. Other character heights and brightnesses are available to special order.

The large displays are based around a common power and control card which is linked to display units of different sizes.

Instrument behaviour is set by way of remote contact closure pushbuttons, which provide access to and alteration of the instrument's menu, and the settings are stored in 10 year non-volatile memory.

2.1 GENERAL SPECIFICATIONS

Display type	Dual Input elapsed timer . UP or DOWN	
Signal inputs	Contact closure, NPN, PNP, 5V TTL/CMOS, 24VDC	
Input Resistances:	2200 Ohms if internal pull-up/down enabled. Otherwise 10M	
Excitation Supply:	Nominally 13VDC at 60mA max.	
Accuracy:	0.1% of displayed value worst case error	
Scaling	Select timing format with configuration number.	
Signal Output (optional)	RS422 at 300, 1200, 2400 or 9600 Baud	
Output Data format (optional)	Serial ASCII at 300,1200,2400 or 9600 baud; 1 start bit, 8data (or 7 data plus parity) and 1 or more stop bits.	
Handshake	No handshake, unit always transmits data	
Case material:	UPVC, White or Black	
Case size:(mm WxH)	4 or 5 digit	6 or 7 digit
	2" 288x120	384x120
	4" 480x168	672x168
	6" 624x192	864x192
Case depth :	90mm (115 mm including rear cable/glands)	
Weight :	4 or 5 digit	6 or 7 digit
	2" 2.5Kg	3Kg
	4" 4.5Kg	5Kg
	6" 5.0Kg	6Kg
Display type:		
2" digit height	High efficiency red LED 57mm high 7 segment display tiles	
4" digit height	Ultrabright red LED 102mm high 7 segment display tiles	
6" digit height	144mm high characters formed from twinned individual 5mm round red LEDs	
Daylight viewing versions, whether 2", 4" or 6" are made up of individual 5mm round lensed LED's		
Power supply :	95-264VAC, 100 to 300 VDC, Via Rectifier, non-specific polarity	
Power consumption:	20W typ.	without thermostatic heater.

3.0 INTERNAL CABLES

The units are supplied with approximately 2 metres of free ended cable for mains, signal and serial ports. You may connect your own cable to this, via a junction box, or completely remove the supplied cable and install your own.

REMEMBER The signals you will be feeding to the displays are quite small in comparison to some of the undesirable 'noise' generated by certain types of common electrical equipment. To obtain the highest degree of accuracy and reliability from your indication equipment, we strongly suggest that you....

DO NOT run signal cables adjacent to power/switching lines or near equipment liable to generate large amounts of electrical noise, such as contactors, solenoids, fluorescent tubes, discharge lamps, motor control equipment, etc.

Do use screened, twisted-pair extension cable to minimise the amount of noise being fed into the display.

WARNING: RISK OF LETHAL ELECTRICAL SHOCK



YOU MAY NEED TO OPEN THE CASE TO ALTER JUMPER POSITIONS OR TO PANEL MOUNT THE DISPLAY. BEFORE COMMENCING TO OPEN THE CASE YOU **MUST ENSURE** THAT POWER HAS BEEN **DISCONNECTED**, AND MUST ENSURE THAT POWER CAN IN NO CIRCUMSTANCES BE RE-APPLIED TO THE DEVICE WHILST THE CASE IS OPEN.

3.1 SIGNAL CABLES

The signal and data connectors are at the left hand end of the power and control card. They are connected to extension cables, which are accessible from the rear of the display.

Do not earth the screen or braid of the input, data output or programmer cable outside the display, as it is already internally earthed to the 'screen' terminal.

Top Connector

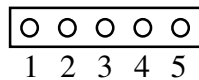

Pulse Inputs

- 1=Screen Braid
- 2=Common Blue
- 3=Input A Red
- 4=Input B Green
- 5=+Excitation Yellow

Middle Connector

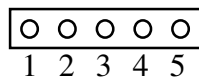

Remote Programmer

- 1=Screen Braid
- 2=Common Red
- 3=Select Green
- 4=Increment Blue
- 5=Menu Yellow

Bottom Connector (optional)

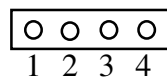

Serial Data O/P

- 1=Screen Braid
- 2=Common Yellow
- 3=Data B Green
- 4=Data A Blue

3.2 MAINS CABLES

The unit incorporates a switching power supply to enable the unit to operate over the full 95 to 265 Volts range.

The **mains lead** must be of 3 core construction, with the earth wire **bonded to a good earth.**

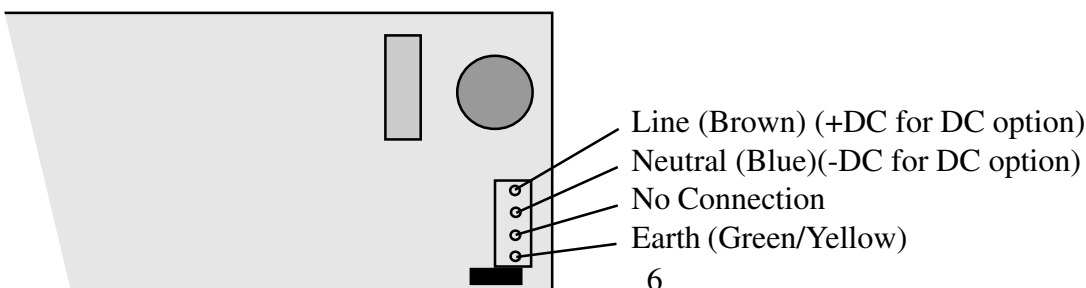

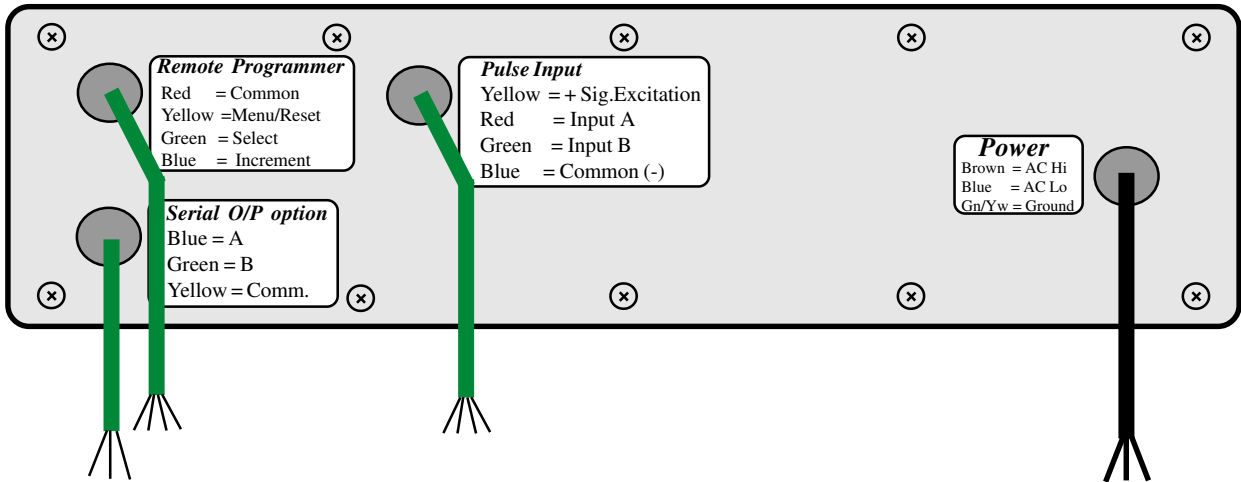

4.1 PULSE INPUT SELECTION

If, when ordering your display you specified the input type required, this will have been set for you prior to despatch, and should be noted on the label on the rear of the display. If you **did not specify** the input type, this will be the **factory default of NPN/Contact closure**. You can re-configure the meter, by making internal jumper alterations, to accept PNP, 24VDC, TTL etc.

4.1.1 JUMPER FUNCTIONS AND POSITIONS

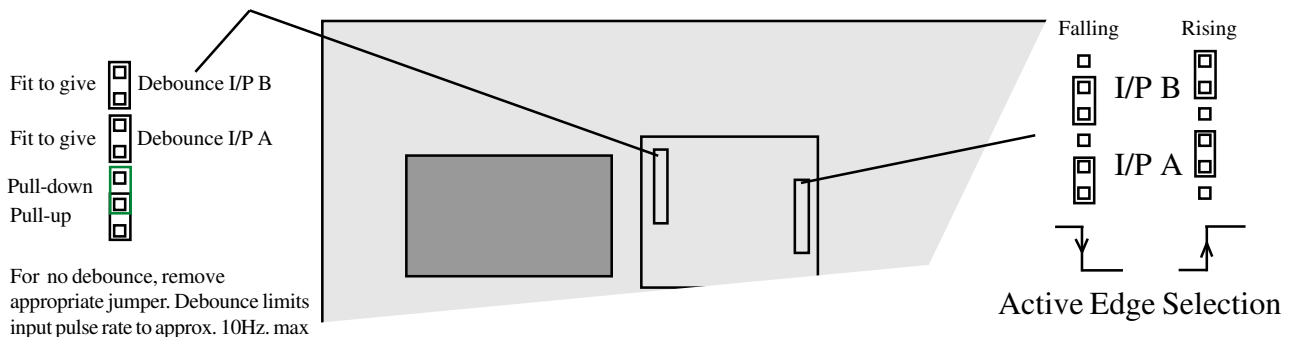

The internal circuitry is arranged as follows:-

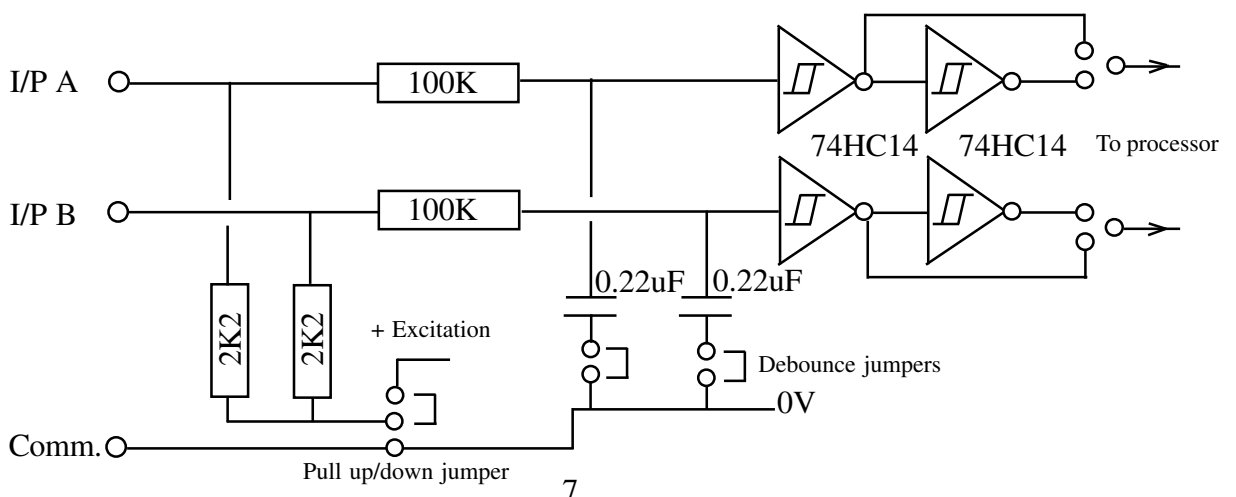

SIGNAL, DATA AND CONTACT CLOSURE CONNECTIONS

4.2 Typical Input Connections

The most common input sensor types are shown below, with a wiring guide, to assist you in the installation of your totaliser. Only one input is shown, as they both have identical input circuitry. Because the pullup resistors are not independent (both inputs will be pulled up or down), you should choose sensors which require the same pullup format, if using both inputs. In other words, do not use a PNP sensor for one input and an NPN sensor for the other. You could, however, have a NPN sensor for one input and a contact closure for the other. However, Reset is ALWAYS contact closure

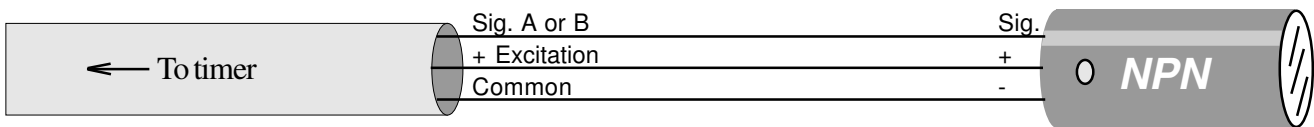

Jumper Settings: Fit Debounce jumper if input rate is less than 10 per second
Fit Pull-up jumper
If count is to increment when item approaches sensor, fit falling edge jumper.
If count is to increment when item leaves sensor, fit rising edge jumper.

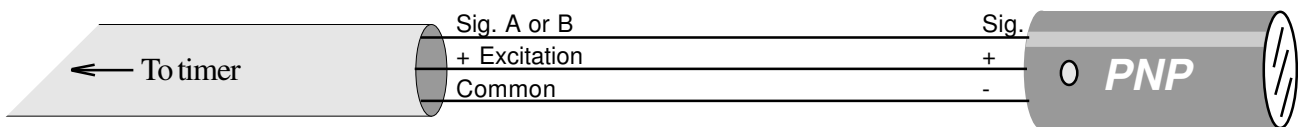

Jumper Settings: Fit Debounce jumper if input rate is less than 10 per second
Fit Pull-down jumper
If count is to increment when item approaches sensor, fit rising edge jumper.
If count is to increment when item leaves sensor, fit falling edge jumper.

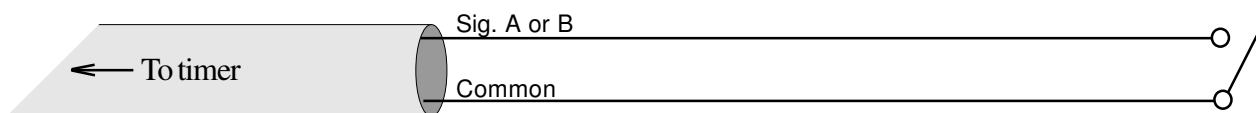

Jumper Settings: Fit Debounce jumper. Input rate must not be greater than 10 closures per second
Fit Pull-up jumper
If count is to increment when contacts close, fit falling edge jumper.
If count is to increment when contacts open, fit rising edge jumper.

4.3 RS422 Data Output Option:

The Serial Data O/P allows you to feed the measured reading to serial input slave displays, such as our S17XX series, or small 1/8 DIN SER-06 models, for remote indication purposes.

The output is continuous, with a new string transmitted at roughly 1 second intervals. The format is the reading itself, including decimal point character, in ASCII, terminated by a Carriage Return. The data format is 1 start bit, 8 data bits and 1 stop bit. The Baud rate is selectable, and is determined by the fourth character of the Configuration Number. Extension cable should be screened, high quality data cable, and should be routed away from sources of electrical noise such as motors, power cables, inductive devices, discharge lighting circuits etc. **Do not** earth the screen of the data cable, however, as it is already connected to internal earth on the display itself.

Up to 32 slaves having RS422 inputs can be driven from the optional output port.

The Timer offers useful flexibility in resolution and display presentation, and all parameters are adjusted by using the three contact closure programming pushbuttons.

It is worth spending a little time familiarising yourself with the menu and the programming technique before carrying out a full calibration. The menu structure is described below, and is followed by a flow diagram to add clarity.

The flow diagram uses pictures of our Remote Programmer, consisting of three pushbuttons, arranged as follows....

If you make up your own programmer, please be sure to use good quality pushswitches, and lay them out in the same order as shown here.

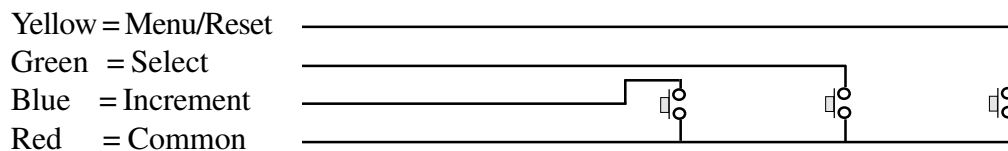
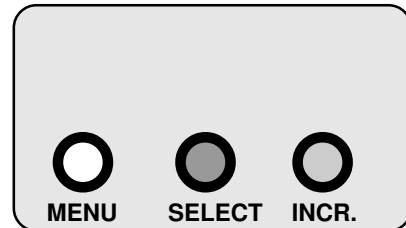

The Blue (increment) line is also used for remote reset

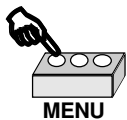

Allows you to step down all the variable options when in programming mode. Also allows you to reset the display to zero when in normal running mode.



Allows you to select a digit within a variable, for alteration. The digit which can be altered flashes. Each time you press 'SELECT' the flashing digit moves one place to the right. Also allows you to set the display's brightness when in normal running mode.



Allows you to increase the value of any flashing digit. Each press will increase the value by 1. Also used to Reset the display to 0 or to Preset start time. .

E1700 Series Configuration numbers.

Use the 4 digit configuration number to choose various types of timing functions.

Each digit has a specific function, as follows:-

Display Syle
 (do not set 1,6 or 7)
0 = MM:SS:SS
2 = HH:MM:SS
3 = MM:SS
4 = DD:HH:MM
5 = HH:MM
8 = SSS.SS
9 = SSSS.S
A = MMM.MM
B = MMMM.M
C = HHH.HH
D = HHHH.H
E = DDD.DD
F = DDDD.D

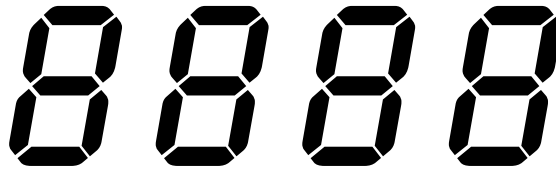

Size/Control - to suit display hardware
0 = 2" & 4" displays
1 = 6" & 8" displays
2 = 2" & 4" displays with relay
3 = 6" & 8" displays with relay
4 = 2" & 4" stop at 0 or preset
5 = 6" & 8" stop at 0 or preset
6 = 2" & 4" displays with relay stop at 0 or preset
7 = 6" & 8" displays with relay stop at 0 or preset

Serial Data Baud rate
0 = 1200 Baud
1 = 2400 Baud
2 = 4800 Baud
3 = 9600 Baud

Control Functions
0 = Up Count I/P1=Start, I/P2=Stop
1 = Down Count I/P1=Start, I/P2=Stop
2 = Up Count Only counts when I/P1 active
3 = Down Count Only counts when I/P1 active
4 = Up Count I/P1 toggles Run/Stop
5 = Down Count I/P1 toggles Run/Stop
8 = As '0', but starts at Reset pulse
9 = As '1', but starts at Reset pulse
A = As '2', but starts at Reset pulse
B = As '3', but starts at Reset pulse
C = As '4', but starts at Reset pulse
D = As '5', but starts at Reset pulse

E174X Menu Flow Diagram

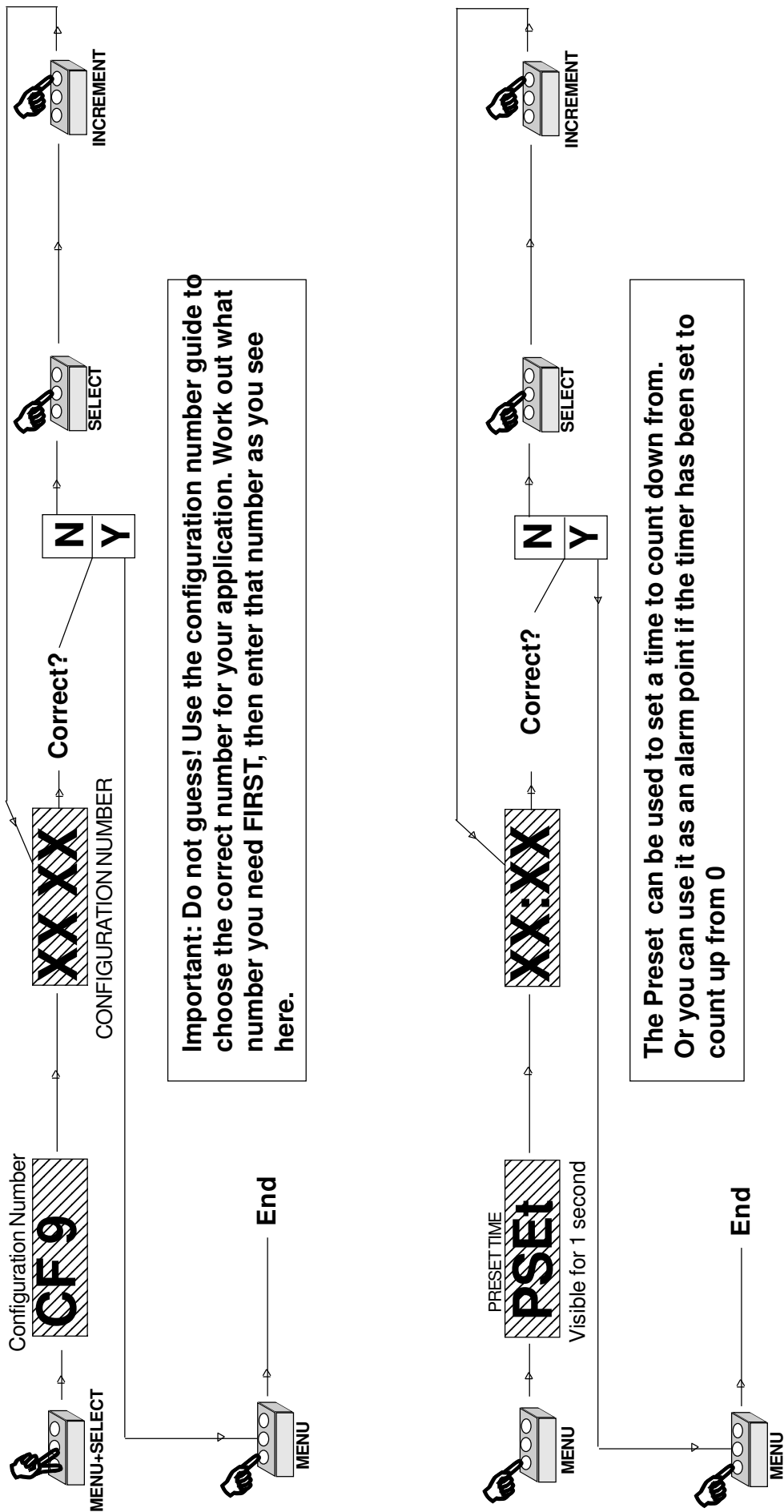

Reset . To reset your timer to 0 or Preset, make a momentary contact closure on the INCREMENT line.

Brightness. To choose a brightness level to suit your environment, press SELECT.

4.8 Application Examples

Here are a few common applications, with examples of how the displays are set up to achieve the timing .

Please feel free to call our Application Engineering Department for assistance with your particular application, if you so wish, and we shall be pleased to help you.

1. Timing a task in a production environment.

Minutes and Seconds MM:SS readout. Order a 4 digit display with digit size to suit your required viewing distance.

Assume a button is pressed when the operator starts a process, and another button pressed when the process is completed.



Set Configuration number = 3000 for 2"/4" displays or 3100 for 6"/8" displays.

2. Predictive maintenance - how long has a machine been running?

Show hours up to 9999.9. Order a 5 digit display with digit size to suit your required viewing distance.

Assume that a contact is closed whenever a machine is running. connect this contact



Set Configuration number = D002 for 2"/4" displays or D102 for 6"/8" displays.

3. Cure-Time monitor and alarm

You want to time how long a resin cures for, in an oven. The ideal cure time is known to be 42minutes.

You want an alarm to occur when the cure time is complete. You want to see how much longer the process needs to continue for - time remaining.

For this application, you'll set a Preset of 42:00 minutes. You'll also set the configuration to make the timer count down from Preset time to 0 and generate an alarm when reaching 0.



Set Configuration number = 3603 for 2"/4" displays or 3703 for 6"/8" displays.

5.0 INSTALLATION

If possible position the display away from heat and direct sunlight on the display face. The displays should not be exposed to substances liable to damage uPVC, acrylic or glass.

If mounted outside, the display should be protected by a shroud to limit direct falls of rain, the cooling effect of which can give rise to the display sucking in moisture.

DO NOT remove the cables supplied with the indicator, as these contain essential filter components. You should extend cables with a junction box rather than remove and substitute cabling. Screening must be used on your cables.

REMEMBER The signals you will be feeding to the displays are quite small in comparison to some of the undesirable 'noise' generated by certain types of common electrical equipment. To obtain the highest degree of accuracy and reliability from your indication equipment, we strongly suggest that you....

DO use screened, twisted-pair cable to minimise the amount of noise being fed into the display.

DO NOT run signal cables adjacent to power/switching lines or near equipment liable to generate large amounts of electrical noise, such as contactors, solenoids, fluorescent tubes, discharge lamps, motor control equipment, etc. **DO NOT** earth the screens of signal, data or programmer cables, but **DO** earth the screen on mains cables.

5.1 MOUNTING POSITIONS

The unit as supplied is suitable for panel mounting, or may be free standing. Optional mounting kits provide for wall mounting, suspension mounting and vertical or horizontal links for multiple units

5.2 PANEL MOUNTING

The panel cutout sizes in mm +/- 1mm are as follows .. (width x height):

Digit Height	4 or 5 digit	6 or 7 digit
2"	279x111	375x111
4"	471x159	643x159
6"	615x183	855x183

Method :

Remove fixing screws and slacken the cable glands. Ease rear case off front section, leaving rubber gasket on front section. Offer front section up to panel cutout. Feed cables through glands in case rear. Slide rear over front section, pulling any excess cable through glands. Fit all screws and washers, and finger tighten glands.

5.3 WALL MOUNTING

Fixing centres (mm, horizontal) Hole pitch 100mm vertical

	4 or 5 digit	6 or 7 digit
2"	288	384
4"	480	672
6"	624	864

Method : Fix the wall mounting brackets to the wall with rawlplugs and screws or nuts and bolts.
Offer the case up to the brackets and insert the screws and washers supplied at each end of the case. Note the position of the friction washers. Tighten the mounting screws sufficiently to hold the display in position. Do not over-tighten.

5.4 SUSPENSION MOUNTING

Method :

Connect the U shaped bracket with the supplied screws and washers to each end of the display. Tighten the screws sufficiently to hold the display in place. Do not over-tighten.
Drill an 8.5mm diameter hole in the beam where the display is to be fitted. Slide the supplied bolt through the bush. Feed this through the center hole of the suspension bracket and place the bearing washer on top. Push the bolt through the drilled hole and secure with the nut and washers supplied. Please note that the drilled hole should be sufficiently clear from any obstruction to allow the display to swing 360 degrees and pivot up and down.

5.5 MULTIPLE DISPLAY MOUNTING

Refer to the information supplied with the mounting kit.

The Large displays have been designed to provide a long trouble-free life and require no routine maintenance. An annual calibration check is recommended.

The front lens may be cleaned with a proprietary window cleaner, and the case may be hosed down, and cleaned with a cloth dampened with mild detergent. Surface scratching can be polished out with a mildly abrasive cleaner such as perspex cleaner.

The mains power supply is for 95 to 264 volts AC, so there is no risk of applying 240 volts to a 110 volt unit. Filtering is incorporated on the mains input, to prevent damage due to short spikes on the mains.

Damage will occur if the unit is subject to 415 volt mains application.

Check wiring prior to powering the units!

Technical helpline 01462 850967 Please make a note of full model number, serial number and configuration number before calling us. *Please also read the manual before calling*, and , if you find any part unclear, or do not find the information you need, let us know. That way we can improve future editions of the manual for you.

7.0 SAFETY CONSIDERATIONS

The 1700 series is protected in accordance with IEC Safety Class 1. The instruments are designed and tested in accordance with IEC publication 348, 'Safety Requirements for Electronic measuring apparatus', and are supplied in a safe condition.

Whenever protection is likely to have been impaired by damage, the equipment shall be made inoperative and be secured against any intended operation.

Removal of the rear cover **WILL EXPOSE LIVE PARTS.**  The equipment must be disconnected from the supply before carrying out any adjustments, replacement, or repair with the case opened. If any work is carried out with the equipment opened and powered, it shall only be carried out by a skilled person who is aware of the hazard involved.

Mains connections:

The unit is operable as soon as the mains is applied, there is no mains switch.

The equipment must be connected to a protective earth. Any interruption of the earth conductor inside or outside the equipment is likely to make the equipment dangerous.

The mains and signal leads should not be allowed to collect within the instrument; all excess lead must be pulled out through the cable glands.

Note that capacitors inside the instrument may still be charged when the equipment has been disconnected from the supply. Before carrying out any work inside the equipment, a period of one minute should be allowed for capacitors to discharge; to discharge the mains filter capacitors, short together the live and neutral mains wires.

R F I

The equipment generates and uses radio frequency energy, but when properly installed as described, complies with EN55022. The equipment is certified as meeting EN50081-1 and EN50082-1

Shielded cables **MUST** be used for all signal and data leads, but use of a shielded mains lead is not required. The power earth wire must be bonded to a good earth, but **DO NOT** earth the signal, data or remote programmer screens.

8.0 Warranty

London Electronics Ltd. warrants its products against defects in materials or workmanship for a period of one year from the date of purchase.

In the event of a defect during the warranty period, the unit should be returned, freight(and all duties and taxes) prepaid by the Buyer to the authorised London Electronics Ltd. distributor from where the unit was purchased. The Distributor, at its option, will repair or replace the defective unit. The unit will be returned to the Buyer with freight charges prepaid by the distributor.

LIMITATION OF WARRANTY

The foregoing warranty shall not apply to defects resulting from:

1. Improper or inadequate maintenance by the buyer.
2. Unauthorised modification or misuse.
3. Operation outside the environmental specification of the product.
4. Mishandling or abuse.

The warranty set forth above is exclusive and no other warranty, whether written or oral is expressed or implied. London Electronics Ltd. specifically disclaims the implied warranties of merchantability and fitness for a particular purpose.

EXCLUSIVE REMEDIES

The remedies provided herein are the buyer's sole and exclusive remedies. In no event shall London Electronics Ltd. be liable for direct, indirect, incidental or consequential damages (including loss of profits) whether based on contract, tort or any other legal theory.

9.0

Other London Products

We also design and manufacture a broad range of panel meters, controllers, transmitters, and other types of Large Displays.

1/8 DIN Panel meters

Inputs accepted include...

- Pulses- Totalisers & Quadrature
- Pulses - Ratemeters
- 4-20mA
- 0-10V
- Thermocouples
- RTD's
- AC Volts and Current
- Resistance
- Slidewire position transducers
- Loadcells
- Torque transducers
- RS232, RS485, RS422, 20mA TTY
- BCD

We also produce Custom special instruments, designed for you from your requirement specifications

Large Displays

Other forms of large displays manufactured by London Electronics Ltd. include.....

- Serial Input remote displays
- Ratemeters
- Process Indicators
- Weight Indicators
- Draw Meters
- Rate of Change indicators
- Clocks

For a **Full Catalogue and PriceList**, please call us on **01462-850967**, and we will despatch details immediately.

9.0 **AND FINALLY...**

We really would appreciate receiving any comments you may wish to make after receiving your **LONDON ELECTRONICS LTD.** Large displays.

In particular , if you experienced any difficulties during any stage of your purchase, your comments will enable us to serve you better in the future.

Similarly, if there are any additional features you feel you would benefit from by having them included in our range of equipment , please let us know and we will give your suggestions serious consideration.

Please complete the section below and return it to us as soon as possible so that changes can be made without delay.

Thank you for choosing products from **LONDON ELECTRONICS LTD. !**

LONDON ELECTRONICS LTD. Warren Court, Chicksands, Shefford SG15 5QB

TEL:- 01462 850967

FAX:-01462 850968

NAME _____ JOB FUNCTION _____

COMPANY _____

ADDRESS _____

POST CODE _____ TEL. NO. _____

MODEL NUMBER _____ SERIAL NUMBER _____

BRIEF APPLICATION DESCRIPTION _____

COMMENTS _____

SIGNED _____ DATE _____

Notes

Declaration of Conformity

Declaration Number : EMC1700 Iss. 3
Issue Date : 21 April 1997
Products Covered : 1700 Series Large Displays
Title : Large Process, Serial
Rate & Totalising Displays

This is to confirm that the Products covered by this declaration have been designed and manufactured to meet the following specifications :

EN55022:1987 Conducted Emissions: Class B
EN55022:1987 Radiated Emissions : Class B
IEC801-2:1984 Electro-Static Discharge Immunity: 8kV Air
IEC801-3:1984 Radiated ElectroMagnetic field Immunity: 3V/m
IEC801-4:1988 Fast Transient Immunity : AC 1kV, cable 0.5kV

Thus the products conform with the applicable sections of the following standards:

EN50081-1:1992 (normative)
EN50082-1:1992 (normative)

and comply with the requirements of Council Directive 89/336/EEC relating to Electro-Magnetic Compatibility and 72/23/EEC relating to safety.

To confirm compliance, representative models within the range have been independently tested and certified by MARCONI INSTRUMENTS EMC Department.

MARCONI CERTIFICATE # : TC96/029C
MARCONI CERTIFICATE Issue # : 1
MARCONI Certificate Issue Date : 14 February 1996

Conditions

The meters are permitted a worst case error of 1% of A/D range during electro-magnetic disturbance, and must recover automatically when disturbance ceases without the need for human intervention, such as resetting, power-down etc.

The meters covered by this certificate must be installed in adherence to the following conditions :-

Signal cabling shall be routed separately to power carrying cabling (includes relay output wiring)
All signal cabling shall be screened. The screen shall only be terminated to the power earth terminal

This certificate applies only to meters carrying Serial Numbers 601001 or higher.

Certified as true and correct, for and on behalf of London Electronics Ltd.
Warren Court, Chicksands, Shefford, Bedfordshire SG17 5QB

J.R. Lees
Director