

# London Electronics Limited

Thorncote Green, Near Hatch, Sandy, Bedfordshire SG19 1PU  
Tel +44(0)1767 626444 Fax +44(0)1767 626446  
www.london-electronics.com help@london-electronics.com

**Obsolete - now replaced by MAXI-INT2-P**

## Model MAXI-INTUITIVE-P

Digital Process Indicator / Controller

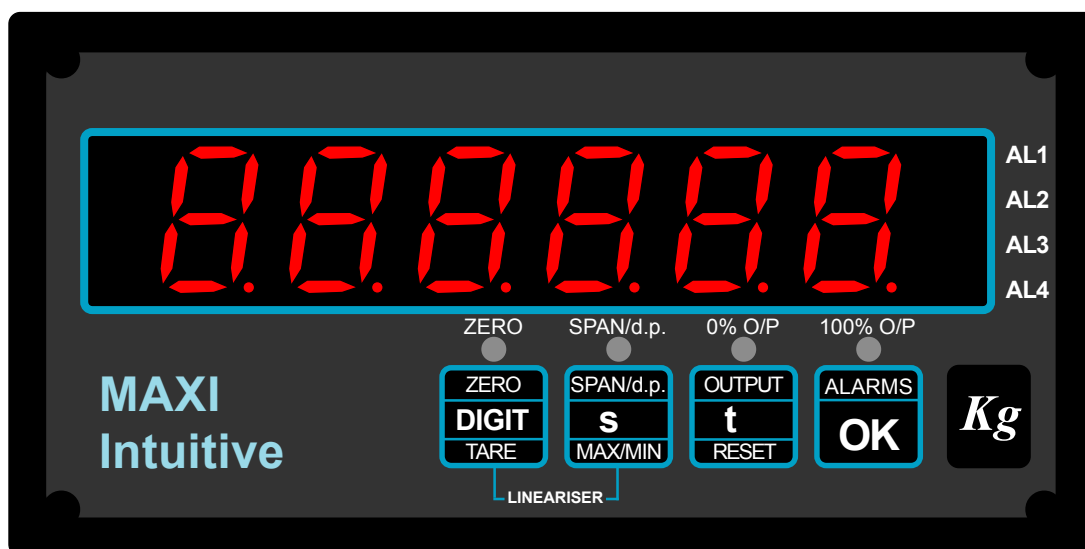

Software version 4.6

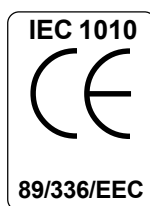

Patent App. Numbers :- UK=GB9820695.6, EU=99307553.0, USA 09/401738, Canada 2283378

Document Ref:pm65\manuals\MAXI\_INTUITIVE\_P46

Revision:2 Dated: 8 March 2004

# Alphabetic Index

Alarm board Configuration	14
Alarms, how to set	15
Analogue Output configuration	17
Analogue output, how to set	18
Calibration method selection	6
Calibration - Direct method	8
Calibration - Theoretical method	7
Calibration - Tamper detection	12
Connections	5
Count-By (last digit round-up) adjustment	9
Decimal point position selection	7 & 8
Declaration of Conformity	23
Failsafe alarm setting	14
Filter time constant selection	9
General description	3
Getting Started	4
Hysteresis adjustment	15
In-Flight compensation facility	16
Installing options	13
Introduction	1
Input connection examples	5
Linearisation facility	10
Peak / Valley detection and memory	11
Programme memory facility	20
Reset command	12
Revisions record	22
Serial Communications	19
Specifications	21
Tare Command	11
Zero-Drift automatic compensation feature	12
Warnings	2

## Important Introductory Notes

Please feel welcome to contact us if you need help, have a complaint, or if you have suggestions for improving our products or services.

If you contact us about a product you already have, please give us as much information as you can, so we can give you accurate and swift help.

**Software Version:** The display will show VEr. X.X shortly after being switched on. The value X.X is the software version which you must quote when contacting us about technical matters.

Our products have a 2 year warranty, and we will put right or replace any meter found to be faulty through bad workmanship or materials. This warranty does not cover damage caused by misuse or accident.

***IMPORTANT*** If the meter is a vital component in your process, you may wish to buy a spare to cover possible failure or accident, as we cannot guarantee instant repair or replacement. We always try to improve our products and services, so changes to instruments will occur. Please keep this manual safely for future reference, as future manuals, covering revised designs may no longer describe your product accurately.

We believe these instructions are accurate, and that we have competently designed and manufactured the product. We do not make any claims as to the suitability of this product for any particular application. The choice of product and responsibility for the choice lies with the User.

Our full terms and conditions of trading are available on request.

## Warnings



**Please carefully read all warnings and ONLY install the meter when you are sure that you've covered all aspects.**

\* Connect the meter according to current IEE regulations and separate all wiring according to IEC1010.

\* Power supplies to this equipment must be anti-surge fused at 125mA for 230V supply, 250mA for 110V supply or 1A for DC supplies in the range 11-30VDC.

\* Check that model number and supply voltage suit your application before you install the meter.

\* Don't touch any circuitry when the meter is powered, because lethal voltages may be present on the circuit board.

\* We have designed this product for Installation class II service.

\* We have designed this product for use in Pollution-Degree 2 environments.

\* Only adjust switches or connections with the power removed.

\* Ensure all screw terminals are tight before applying power.

***Safety First .....Don't assume anything..... Always double check.  
If in doubt, ask someone who is QUALIFIED to assist you in the subject.***

# General Description

This meter has been designed to be simple to configure. It is easy to use because no menu is used. Look at the front panel below... to adjust ZERO you press the ZERO button, to adjust Span you press the SPAN button, to adjust Analogue Output you press the OUTPUT button, to adjust Alarms you press the ALARM button. There is no need to spend time learning a complex menu system.

The meter's main function is to display physical variables, such as pressure, humidity, level, etc. So, it will accept the most common process signals such as 4-20mA, 0-10V etc. You can use the 24V excitation supply to power 2 wire transmitters, 3 wire transmitters etc. You can linearise signals with the 10 point user-configurable lineariser, a standard feature. Peak and valley memories allow you to view the minimum and maximum recorded measurements.

The meter can give alarm outputs, scaled and isolated analogue output and isolated serial data retransmission when fitted with option boards.

The front panel has a 6 digit, 7 segment window for displaying the measurement. It allows decimal point and minus sign characters to be included and has 4 alarm annunciators to show the status of each alarm relay.



The front panel pushbuttons each have an LED to show which setting is being altered at any time. A clear protective window is provided, behind which you can fit one of our 'Units-of-Measure' labels, to identify the reading as Kg, or Deg. C, or Bar, etc.

A lockout switch on the rear of the meter saves your configuration settings in non-volatile memory, which has a 10 year guaranteed storage period. If the lockout switch is not set ON, your settings could be accidentally altered.

## Getting Started

First, please check that the display will suit all the requirements of your application. Page 4 has some important warnings - please check that all warnings are covered.

If you have analogue output or alarm relay options, you may need to configure their boards before installing the meter in a panel. See the separate sections in this manual for those options.

Check that your panel cutout is correct , 92mm wide, 45mm high. You must fit the meter in a protective enclosure for installation class II service. Remove the 2 screws holding the U clamp at the rear of the case. Slide the meter into the cutout and re-fit the U clamp and screws. Tighten the screws just enough to hold the meter firmly in place and make sure the sealing gasket is evenly held between the panel and the bezel.

Connect the signal and power cables, to the appropriate screw terminal connectors. Check that you are using the correct terminals or you may cause damage to the meter. Do not connect any output or alarm cabling yet.

Apply power, and confirm that the meter illuminates all segments for a few seconds and then shows the software version “VEr. X.X” briefly (The X numerals depend on version).

The lockout switch should be OFF to allow you to change the meter’s settings. Set the scaling to suit your system, using one of the scaling methods described in this manual. Check that the meter responds correctly. Now, adjust your analogue output settings, if necessary, and alarm settings. Use a DVM of sufficient precision to check that the analogue output is operating as required, and use a continuity tester to check that the relay contacts operate correctly. Switch the meter off, and check alarm relay contact status. Check that the contact status suits your system, in conditions of power loss to the meter.

When you have verified all settings, you can connect the alarm relay and analogue output cables, to check that your system operation is satisfactory.

Remember to set the lockout switch ON when you have finished , to prevent accidental loss of your settings.

# Connections

These connectors are only used when options are fitted

Analogue Output		Serial Output				ALARM RELAY OUTPUTS							
Neg.	Pos.	Sig+	Sig-	Comm	Enable	AL1	AL1	AL2	AL2	AL3	AL3	AL4	AL4
14	15	16	17	18	19	20	21	22	23	24	25	26	27

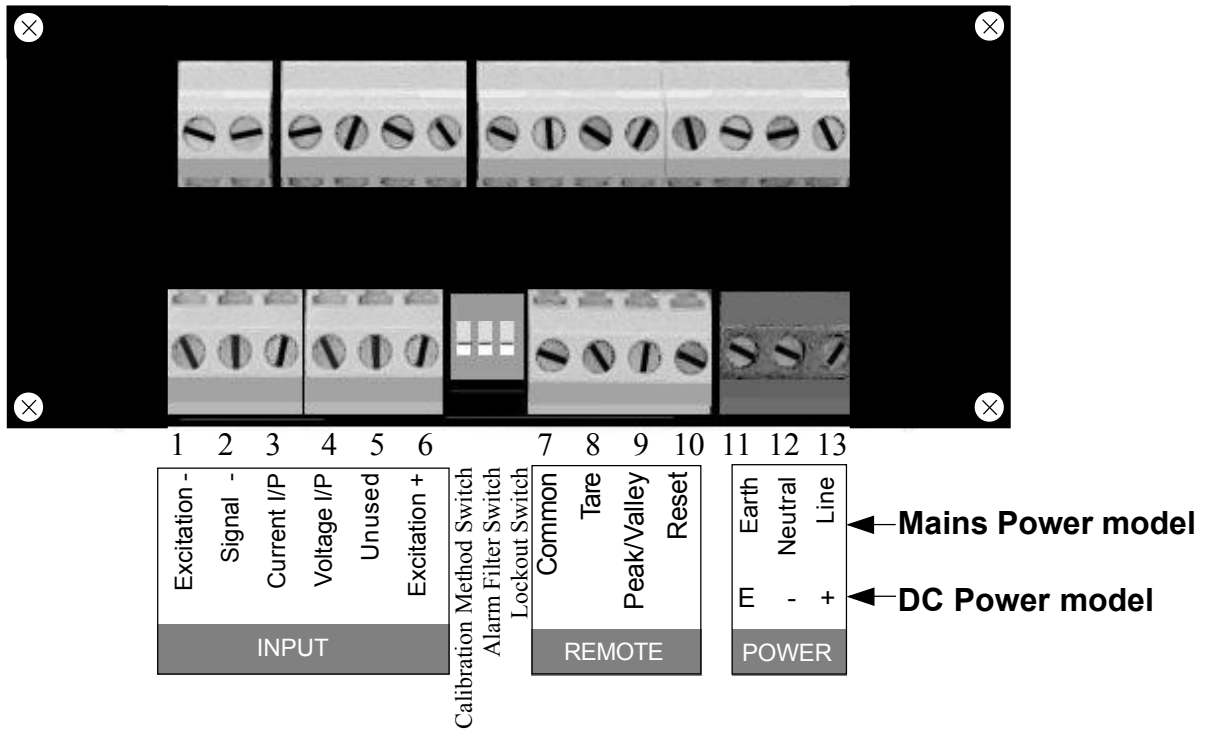

**NB - Switches have changed! Red switches had ON=UP. Blue switches have ON=DOWN**

Cabling should be screened and routed away from noise-carrying cables and machines to reduce interference. The screen can be connected to power earth if it is not already grounded at the sensor end.

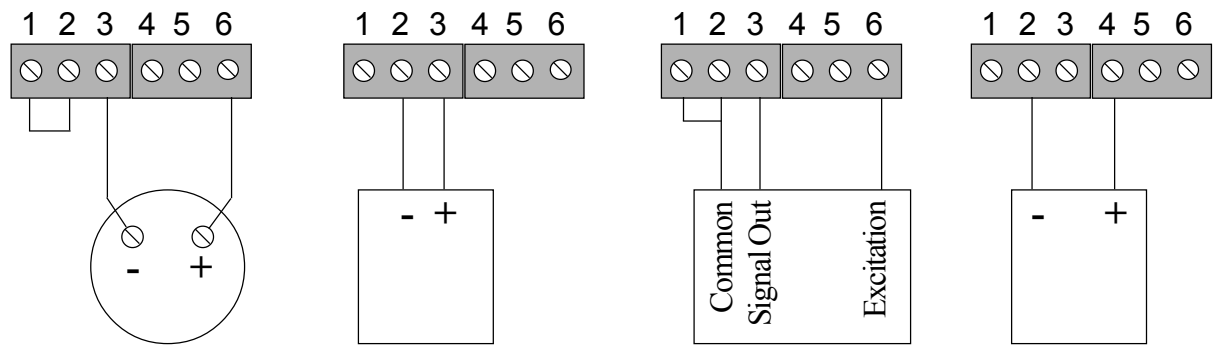

**4-20mA 2 wire transmitter      4-20mA direct      4-20mA 3 wire transmitter      0-10V direct**

**IMPORTANT!**

Set the right-hand switch to its upper 'LOCK' position after setup, to save your settings.

# Choosing a Calibration Method

You can choose one of two calibration methods.

All calibrations are saved by switching 'ON' the lockout switch when you are finished.

## **1) Calibration without an input signal.**

**This is 'THEORETICAL' Calibration (not available with MEM-08 option)**

You can use this method if you know the calibration of your sensor. Assume your sensor gives 4-20mA for 0-250 bar.

You should first select the 'THEORETICAL' calibration switch position on rear of the meter.

Then, using the buttons on the meter, you will tell the meter what 0% input signal level will be (4mA) and what 0% reading value will be (0). Next, tell it what 100% input signal level will be (20mA) and what 100% reading value will be (250)

The Multi-Point linearisation facility is not yet available with this method of calibration. A separate page covers this calibration method in detail.

## **2) Calibration by injecting signals into the meter, either from a calibrator or a sensor installed in a system. This is 'DIRECT' Calibration.**

Select the 'DIRECT' calibration switch position on the rear of the meter.

Inject a signal to the meter equal to 0% of signal range. (If the signal is from a sensor, you don't need to know the value of signal, only what the meter should read. Assume your pressure sensor covers 0-250 Bar) Use the buttons on the meter to tell the meter what to read when no pressure is applied to the sensor.

Now apply a signal 100% of range (If the signal comes from a sensor, apply 250 Bar to the sensor, if possible. If you can't apply 100% of range, apply a lesser, known pressure. Calibration accuracy will be better with larger signals) Use the buttons on the meter to set reading to 250, or the lesser pressure you apply.

A separate page covers this calibration method in detail.

# **‘THEORETICAL’ Calibration**

**Set switch 1, near the input connector ON and lockout switch OFF**

## **1) How to set SPAN and DECIMAL POINT**

Press the SPAN button for 3 seconds. You’ll see ‘dC V’ or ‘dC A’ if the meter is set for DC Voltage or DC current. Use the up or down arrow to change, if needed and then press OK.

You’ll now see ‘In HI’ briefly, then a value, with one digit brighter than the other. This is 20.000 for a 4-20mA input signal, or 10.000 for a 0-10V input signal, 5.000 for a 1-5V input signal and so on. If the value is correct, press the ‘OK’ button, otherwise use the ‘DIGIT’ key to select digits, and the ‘UP’ or ‘DOWN’ arrow keys to alter. When correct, press the ‘OK’ button.

‘rd HI’ appears briefly, then a value, with one digit brighter than the other. This is what will be displayed for the IN HI input. If the value is correct, press the ‘OK’ button, otherwise use the ‘DIGIT’ key to select digits, and the ‘UP’ or ‘DOWN’ arrow keys to alter. The *Decimal point* position may be set after the most significant digit has been selected. When correct, press the ‘OK’ button.

## **2) How to set ZERO**

Press the ZERO button for 3 seconds. You’ll see ‘IN LO’ briefly, then a value, with one digit brighter than the other. This is 4.000 for a 4-20mA input signal, 0.000 for a 0-10V input signal, 1.000 for a 1-5V input signal etc. If already correct, press the ‘OK’ button. Or, use the ‘DIGIT’ key to select digits, and the ‘UP’ or ‘DOWN’ arrow keys to change. When correct, press the ‘OK’ button.

You’ll now see ‘LO rd’ briefly, then a value, with one digit brighter than the other. This is what will be displayed for the IN LO input. If already correct, simply press the ‘OK’ button. Or, use the ‘DIGIT’ key to select digits, and the ‘UP’ or ‘DOWN’ arrow keys to change. When correct, press the ‘OK’ button.

**Now, please set the LOCKOUT switch ON to protect your settings**

# **‘DIRECT’ Calibration**

**Please set all 3 switches OFF**

You must have the meter connected to power and a steady input signal before you start.

## **How to set the Span Calibration and Decimal Point position**

- 1) Apply 100% Cal. signal, and ensure it is steady before proceeding
- 2) Press the SPAN Button for 3 seconds
- 3) The SPAN LED should flash
- 4) Set the display to read your desired fullscale for the signal you're injecting by pressing UP/DOWN Keys. To change the decimal point position, use the DIGIT button to brighten the left-hand digit. Then, one more push of the DIGIT button will allow you to move the decimal point with the UP/DOWN buttons.
- 5) When display correctly set, press OK

## **How to calibrate Zero**

- 1) Apply the Lowest cal. signal and ensure it is steady before proceeding
- 2) Press the ZERO Button for 3 seconds
- 3) The ZERO LED should flash
- 4) Set the display to read 0 , or the desired reading for this signal, by pressing DIGIT SELECT and theUP/DOWN Keys
- 5) Press OK when done

That completes the calibration of your meter.

**Now, please set the LOCKOUT switch ON to protect your settings**

# Filter and Last Digit Roundup

Press the OK button 5 times to access the filter time constant, which is expressed in seconds. You can use the filter to improve your display stability with fluctuating input signals. Use the UP and DOWN buttons to select a time constant in the range 0 to 5 seconds. Bigger time constants give more stability but slower response. Press OK when selected.

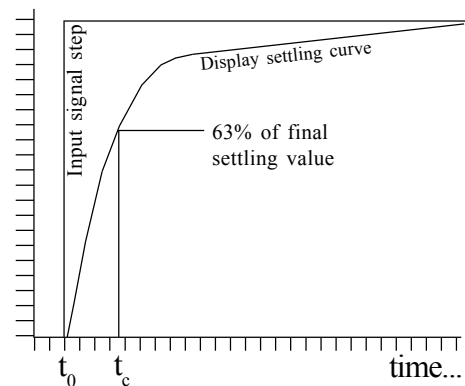

*The Time constant of this digital filter is very similar to the time constant of an RC filter where  $T=RC$ . The time constant is the time it takes for the display to reach 63 % of its final reading value, after a step change on the input. You can see that if you select a 1 second filter time, it will take several seconds for the meter to reach its final value. To give improved response to large step changes, we momentarily cancel the filter action for stable input step changes of over 64 counts, and then re-apply the filter to maintain stability.*

Another function which can give you a more stable display, with less flicker is the LAST DIGIT ROUNDUP.

After the filter setting, the display will show LSt and a number. This number sets the increments by which the meter will change its reading.



Use the UP/DOWN buttons to select a roundup value, and accept by pressing OK.

- |   |                            |
|---|----------------------------|
| LSt = 1 Best resolution, but most sensitive to noise. | Sequence 0,1,2,3,4,5,6 ... |
| LSt = 2   | Sequence 0,2,4,6,8,0...    |
| LSt = 5   | Sequence 0,5,0,5...        |
| LSt = 10  | Sequence 0,10,20,30...     |
| LSt = 20  | Sequence 0,20,40,60...     |
| LSt = 50 Lowest resolution, least sensitive to noise  | Sequence 0,50,100,150...   |

## Using the Lineariser

You can enter up to 10 calibration points, to generate a curved function between input signal and displayed value. Each point **MUST** be greater in value than the previous one and the meter must be set for **DIRECT** calibration method.

**(Note - linearising is not available on MEM-08 option meters or meters set for THEORETICAL calibration)**

- 1) Calibrate the first two points using the **ZERO** pushbutton for the lowest input value and **SPAN** pushbutton for the 2nd input value, using the direct calibration routine. **Do not calibrate SPAN with 100% input !**

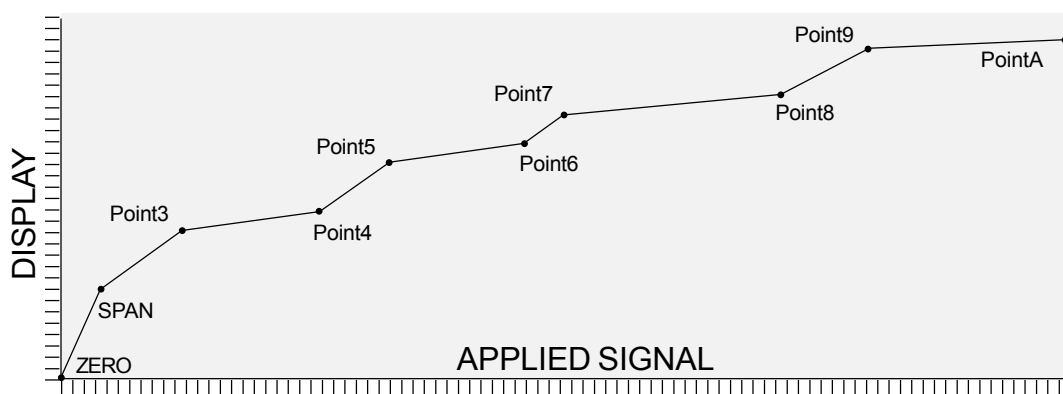

- 2) Apply the 3rd input level and then press both 'LINEARISER' Buttons. Display should confirm by saying POINT3. Adjust the reading to the desired value using the DIGIT SELECT and the UP/DOWN pushbuttons. Press OK when done.
- 3) Apply the 4th input level and then press both 'LINEARISER' Buttons. Display should confirm by saying POINT4. Adjust the reading to the desired value using the DIGIT SELECT and the UP/DOWN pushbuttons. Press OK when done.

You can repeat this process for as many other calibration I/P's you wish to apply, up to a maximum of 10.

There is no time limit with these settings, so you can take as much time as you need to adjust each point. But, power must not be removed from the meter during the procedure, or your settings will be corrupted.

**Please set the lockout switch ON when complete, to save your settings.**

# Features

## **Peak and Valley Detection (Maximum/Minimum Reading View)**

The meter can store the lowest and highest reading values in memory. You can see these values by briefly pressing the MAX/MIN front panel button, or by using remote contact closure switches. The first press shows peak, with the upper left hand indicator bar lit (marked 'Max.'). The second press shows valley, with the lower left hand indicator lit (marked 'Min.'). The display returns to the running value after 2 or 3 seconds. To reset the memory, press the RESET button for more than 3 seconds. Peak and Valley values are not stored if you switch the meter off.

## **How to use the MAX/MIN button to view Peak or Valley**

- 1) Link terminal 7 to terminal 9 (not necessary if MEM-08 option fitted)
- 2) Set lockout switch 'ON'
- 3) Press UP arrow key (MAX/MIN) for peak, valley, normal

## **Remote contact closure viewing of Peak/Valley (Not with MEM-08 option)**

- 1) Connect a normally-open contact closure switch between terminals 7 and 9
- 2) Set the lockout switch 'ON'

## **Tare Command**

You can force the reading to zero by pressing the front panel tare switch for 2 to 3 seconds, or by applying a remote contact closure. Following readings will be the 'net' value, offset by the reading at the time the tare switch was operated. The tare value is stored in non-volatile memory. Press the front panel reset switch for 2 to 3 seconds to cancel the tare value.

## **Front Panel key Taring**

- 1) Link terminal 7 to terminal 8 (not necessary if MEM-08 option fitted)
- 2) Set lockout switch 'ON'
- 3) Press ZERO key to tare display

## **Remote contact closure taring (Not available on MEM-08 option meters)**

- 1) Connect a normally-open contact closure switch between terminals 7 and 8
- 2) Set lockout switch 'ON'

## Features - contd.

### **Automatic Zero-Drift Compensation**

This feature is useful in applications where your meter reads zero most of the time. It cancels long-term zero drift caused by ageing, temperature change, etc. If the reading is within 7 counts of zero for around 100 seconds, the reading will go to zero without changing basic calibration. The correction is **not** stored when the meter is switched off and is cleared if you press the front panel RESET button for more than 3 seconds. To activate this feature, set the display value at 0% input to MINUS ZERO (-0)

### **Calibration Counter / Tamper detector**

An internal totaliser counts each calibration. The 'CAL XX' value appears for a second or two after you switch the meter on. The number starts at 00 and can go up to FF (255 counts). It doesn't count changes of setpoints, or changes of filter value or count-by value. It stores the total in non-volatile memory which can't be reset, so is useful for keeping track of the meter's calibration history.

### **Reset Command**

The reset command clears any stored peak or valley data, any tared offsets and any in-flight compensation data. It may be accessed either from the front panel or by external contact closure command.

### **Front Panel key reset command**

- 1) Link terminal 7 to terminal 10 (not necessary if MEM-08 option fitted)
- 2) Set lockout switch 'ON'
- 3) Press Down Arrow key to reset display

### **Remote contact closure resetting (Not with MEM-08 option meters)**

- 1) Connect a normally-open contact closure switch between terminals 7 and 10
- 2) Set lockout switch 'ON'

# How to install option boards

If you want to open the meter to install or modify option boards, follow these steps...

- 1) Switch off power to the meter and unplug all connectors.
- 2) Remove the 4 small screws from the rear panel, as shown in the diagram.
- 3) Slide the electronic boards out through the rear of the case. We strongly suggest that you use anti-static precautions to prevent damage to the semiconductors.

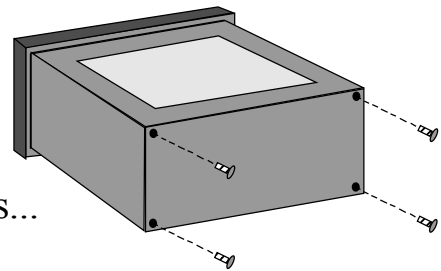

The board assemblies will look something like this...

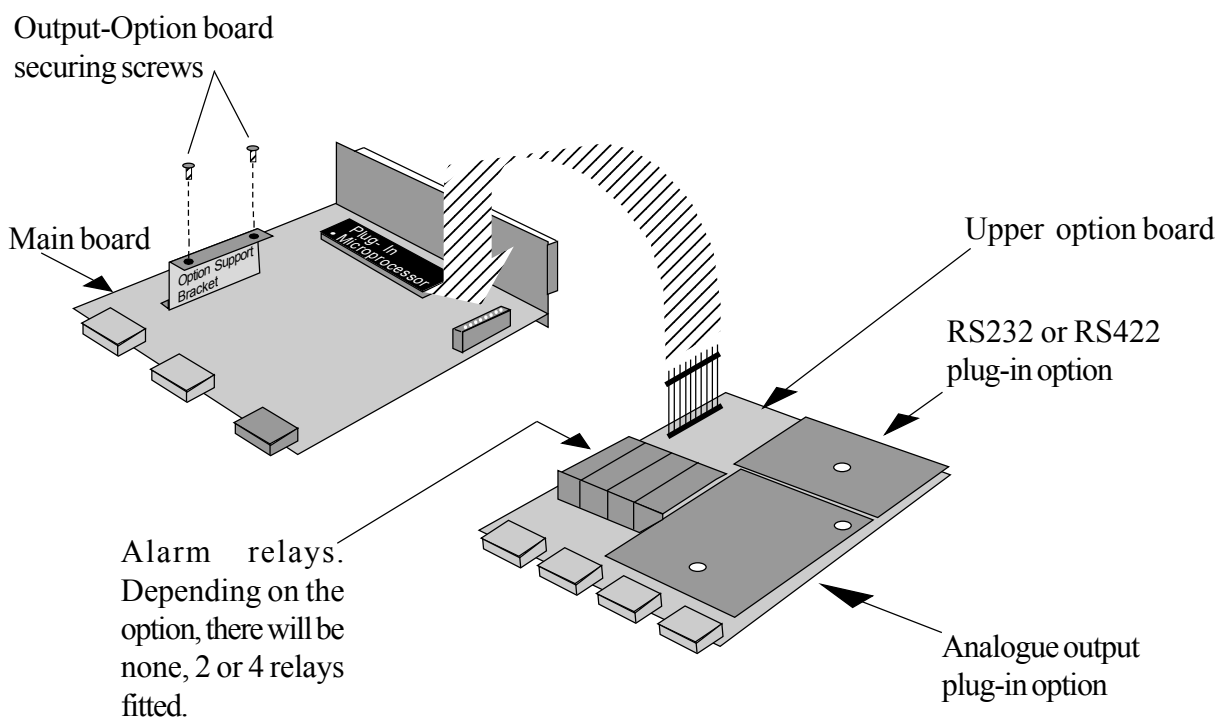

The analogue output and RS232 or RS422 plug-in option boards are fixed to the upper option board with white plastic pillars. You must apply a firm force when fitting or removing these options.

Always be careful to connect the pins to sockets accurately. When reassembling, make sure option boards are firmly fixed to the upper option board, and that the rear pcb fits neatly into the rear panel slots. When the boards are replaced in the case, secure them again with the four small screws in the corners of the rear panel.

# Alarm Board Configuration & Adjustment

For failsafe operation (where contacts open on alarm or when power is lost to the meter) set the jumpers for OPEN CONTACTS and DE-ENERGISE on alarm.

To access to the alarm board, first remove power from meter, including any power which might be on the alarm output circuitry.

Look on the top and bottom surfaces of the case, near the rear. You will see two small screws, one on each surface. Remove both screws. Now, clip off the front bezel and slide the meter assembly carefully out via the front of the case.

The relay board plugs into the main board. Gently separate the two boards.

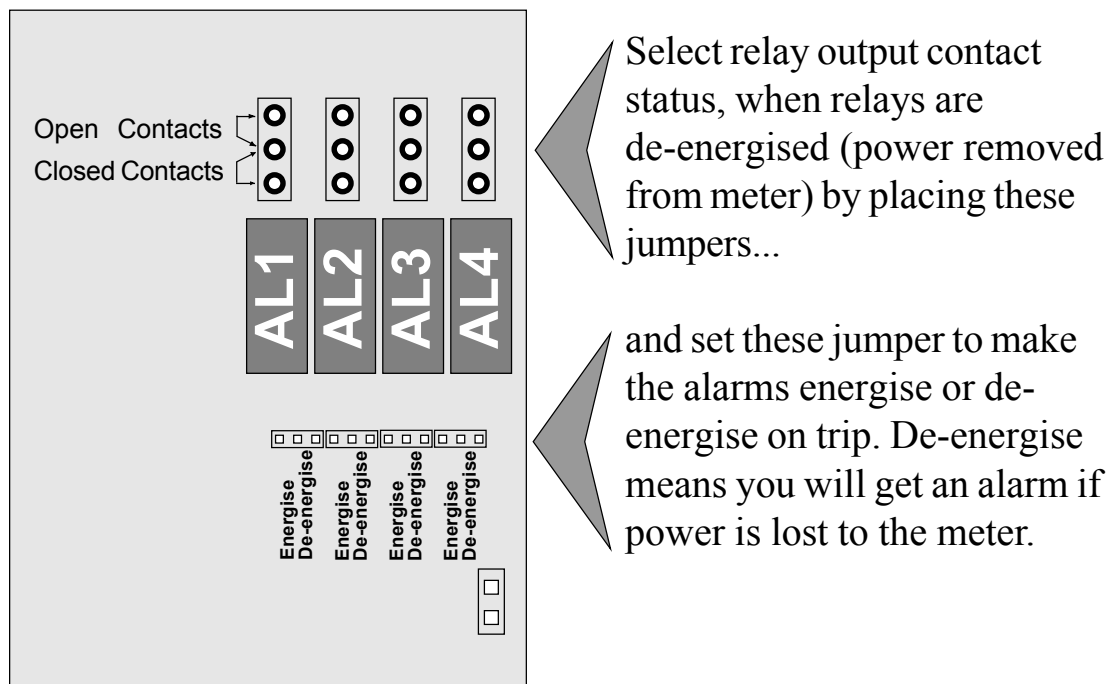

When you have set the jumpers, refit the board to the meter and carefully slide the assembly back into the case.

Fit the two small board screws to the top and bottom surfaces.

# Alarm settings

If you press the ALARMS button momentarily, you can view each of the 4 alarm settings (each press will illuminate in turn AL1, AL2, AL3 and AL4 LEDs). Alarm settings are not locked out by the lockout switch.

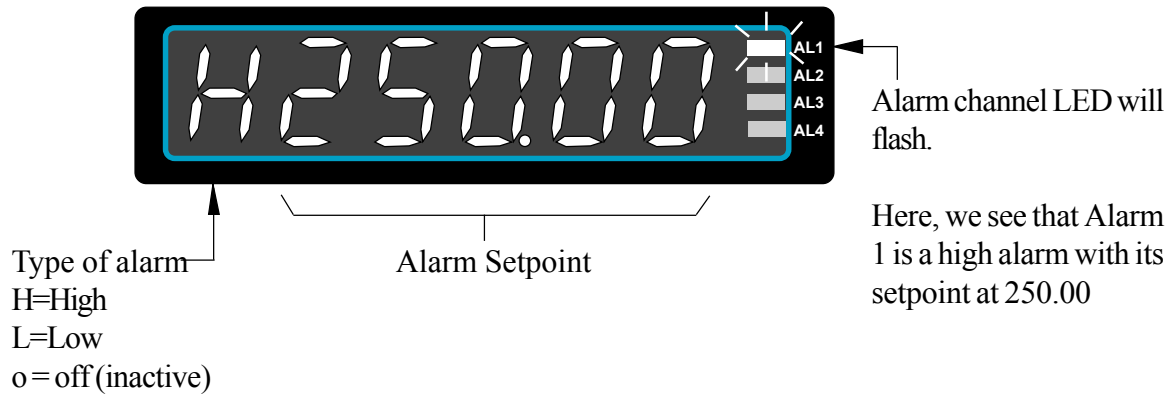

To change alarm settings, select the alarm you wish to change as shown above until its LED is flashing, then press the ALARM key for more than 3 seconds. You will see one digit is brighter than the others. You can change its value using the UP/DOWN buttons, and then select other digits with the DIGIT SELECT pushbutton.

The alarm action is determined by the left-hand character. This will show an 'H' for HIGH alarm action, an 'L' for LOW alarm action, or a 'o' for NO alarm action. You can change this with the UP/DOWN buttons. Press OK when set.

The HYSTERESIS value is identified with a 'HY' prompt, and you can change this to suit your requirements, in the same way as the alarm value.

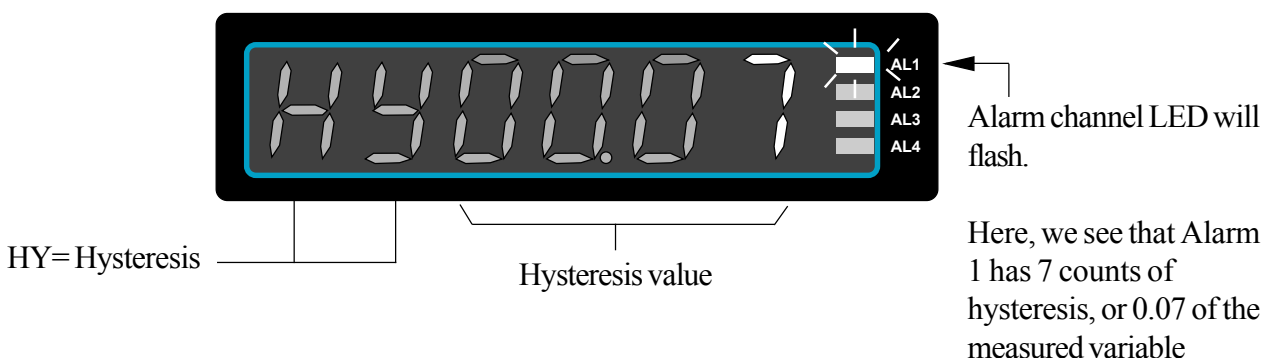

The hysteresis value is directly related to your measurements, so, for example, if you have a high alarm, set to 500, and set the hysteresis value to 7, the alarm will occur when the meter reading rises above 500, and will reset when the meter reading falls to 493. If the hysteresis is set to 9999, the alarms will be provided with 'IN-FLIGHT' compensation (automatic correction for overshoot)

## In-Flight Compensation

You can configure the meter to have in-flight compensation, which can improve alarm accuracy in some applications.

Here's how it works....

Imagine you have a storage container and you want to empty a certain amount of material from that container into a bin.

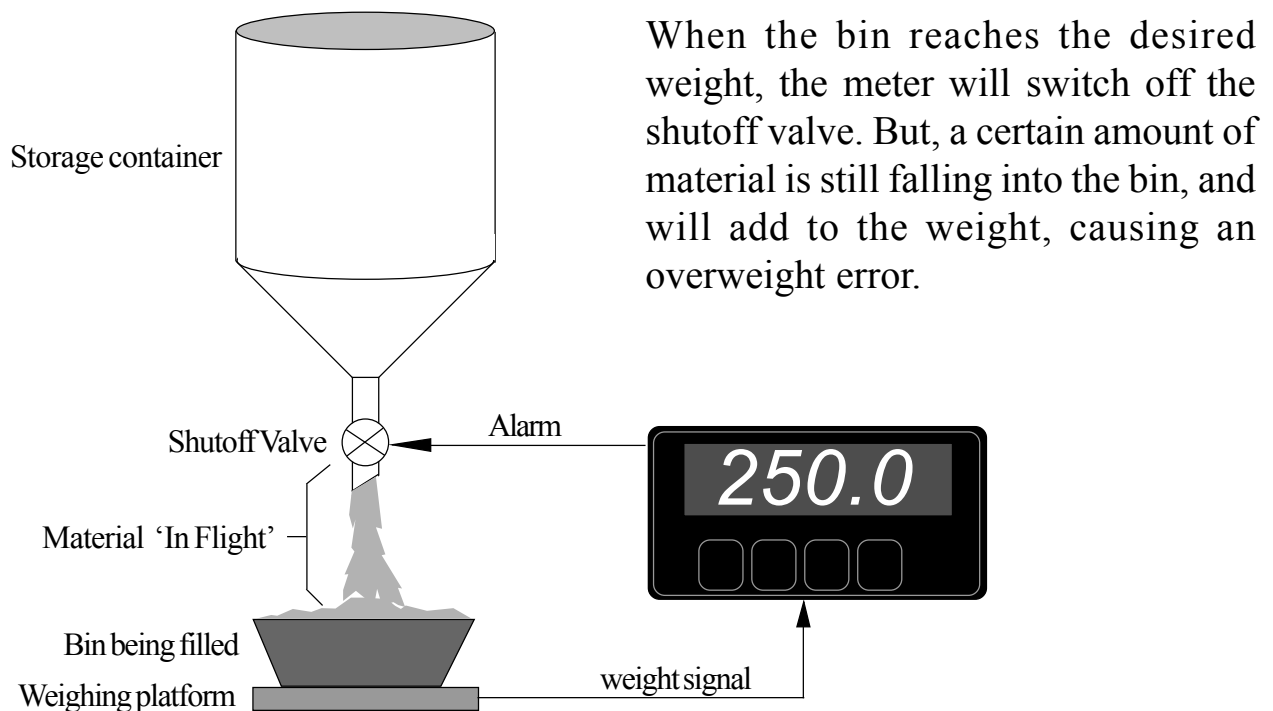

When the bin reaches the desired weight, the meter will switch off the shutoff valve. But, a certain amount of material is still falling into the bin, and will add to the weight, causing an overweight error.

The meter will automatically compare the desired setpoint level to the actual final fill or empty weight, or position, and compensate for any calculated error for the next cycle. This is a continuous process, so if material consistency varies and the in-flight error varies, the meter automatically adapts after each operation.

For the first alarm, the meter will correct for 100% of the measured error, to get as close to desired action as possible. Then, each time the alarm occurs, it will correct for 25% of the previous smaller error, to reduce the effects of material variations.

To use the in-flight compensation, set Hysteresis to 9999 for the alarm channels you need it to operate on.

# Analogue Output Configuration

We always set the meters to suit any requests on your order, so you should not need to adjust the analogue board. If you didn't specify ranges, but ordered option 'ANI', the meter will be set for 4-20mA output. If you ordered 'ANV' it will be set for 0-10V.

If you want to change a range, for example from 0-10V to 4-20mA, the zero and span potentiometers must be adjusted to get best accuracy at 0% and 100%.

You will need to remove the analogue board from the case to change the position of jumpers and to adjust the fine trim potentiometers. See the page headed "How to fit Option Boards" for details of how to expose this board. The analogue board, if fitted, can be seen plugged into the upper board, and can be easily identified because it has either 2 or 3 blue potentiometers, depending on version.

You will need to carefully unplug the analogue output board from the upper board and change the jumper positions to suit your new range, as shown below.

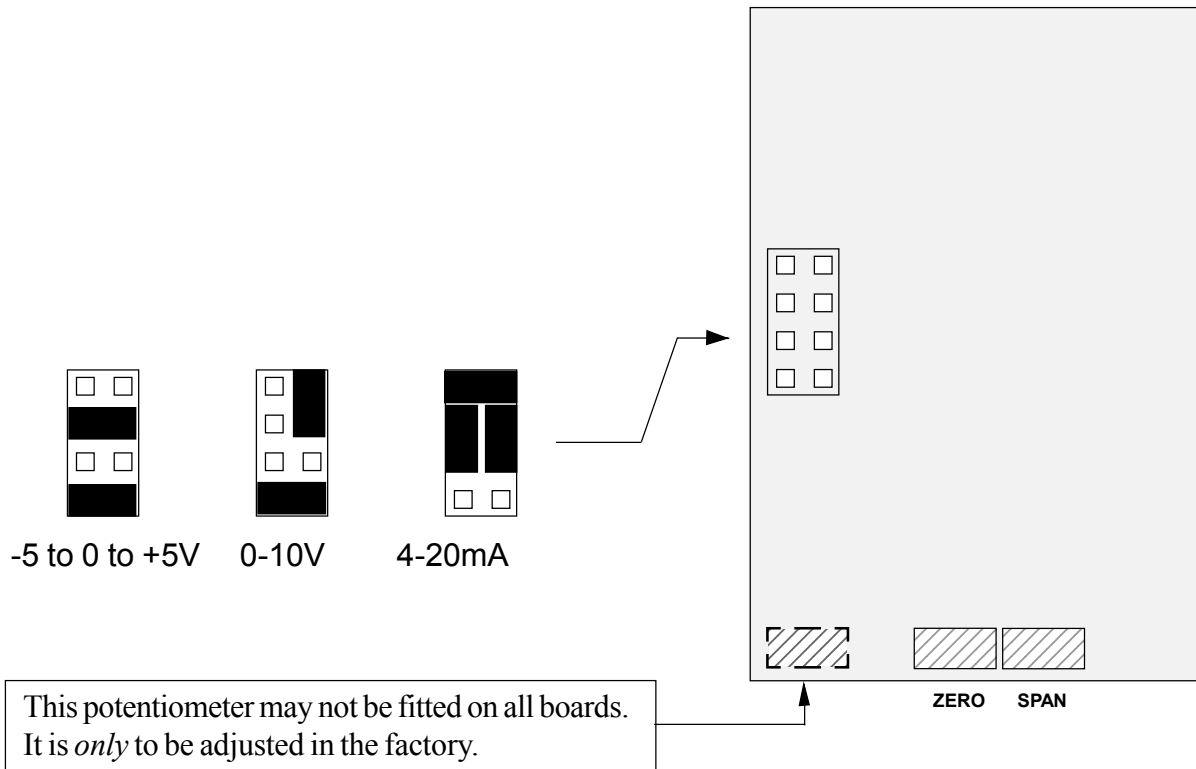

Re assemble the meter, apply power and follow the Analogue Output Settings procedure on the next page. Measure the analogue output and trim, if needed, using the ZERO and SPAN potentiometers, for best accuracy.

# How to adjust your Analogue Output

The lockout switch should be set 'OFF' to change the analogue output calibration. You can set the analogue output range to suit your display range.

The analogue output can be directly proportional or inversely proportional to the display range, for example you can have 4-20mA output for display 0 to 100 or for display 100 to 0.

- 1) Press 'OUTPUT' button for 3 seconds
- 2) 0% O/P LED should flash
- 3) Set the display for the reading value where you want 0% Output, by using DIGIT and UP/DOWN buttons

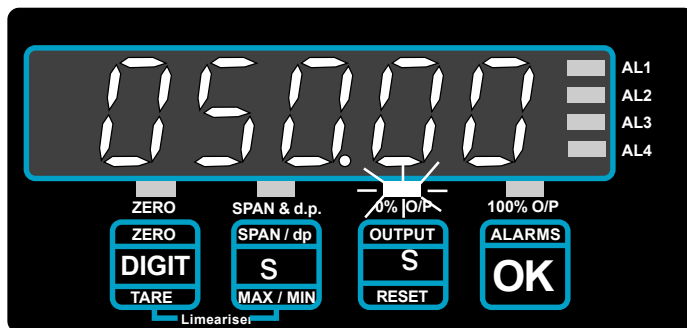

Jumpers on Analogue Board	0% gives
4-20mA	4mA
0-10V	0 V
-5 to +5V	-5V

So in this example, if you set the jumpers for 4-20mA, you will get 4mA output when the display is 50.00

- 4) When set, press the OK button.
- 5) Now the 100% O/P LED should flash
- 6) Set the display to the reading value where you want 100% Output, by using DIGIT and UP/DOWN buttons

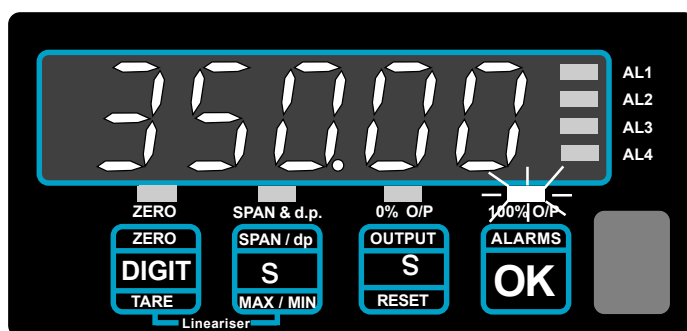

Jumpers on Analogue Board	100% gives
4-20mA	20mA
0-10V	10 V
-5 to +5V	+5V

So in this example, if you set the jumpers for 4-20mA you will get 20mA output when the display is 350.00

- 7) When set, press OK, to complete your adjustment of the analogue output scaling

**Please remember to set the lockout switch 'ON' to save your settings.**

## Serial Communications Output Option

You can have either an RS232 or an RS422 ASCII output at 1200 baud representing the meter's displayed value. You can have a continuous transmission of readings, or a single transmission on demand.

RS232 O/P on terminal 16 (data+) and terminal 18(common)

RS422 O/P on terminals 16 & 17(Data + and -) and 18 (common)

### String Format:

Data is made ASCII coded numerals, with embedded decimal point position if one has been set on the display, with a preceding - sign if the display is negative, with leading zero blanking, followed by a Carriage Return and a Line Feed.

So, for a displayed value of...

12345    the string will be <space><space><1><2><3><4><5><CR><LF>

-15.0    the string will be <space><space><-><1><5><.><0><CR><LF>

### Commands:

The data output port is activated by connecting to the ENABLE terminal.

For RS232, the ENABLE port must be held high at a 5V level for as long as serial data output is required, or, if only one string of data is needed, the ENABLE line must be held high until the transmission starts, after which it may be taken low again. The Sig- connection on terminal 17 may be used to provide the 5V level if an external source is not available

For RS422, the ENABLE port operates in reverse, so must be held low to enable transmission.

If you need a remote mimic display, the Model INTUITIVE-S is an ideal choice, being a 1/8 DIN meter directly compatible with this output format.

Also, we manufacture a range of Large Format remote displays having digit heights of 57mm, 102mm, 144mm, 200mm and 280mm. Ask us about the 1700 Series and the Grand Intuitive Series.

## 8 Programme Memory Option

With the MEM-08 option, you can store up to 8 sets of configuration and calibration data. This is useful if you want to connect a number of different sensors, each with different calibration, to the meter, selected by rotary switch. Each memory location can have its own input/display calibration, alarm settings, and analogue O/P calibration. **NB** The linearisation facility and Theoretical Calibration are **not** available with this option. Nor is external tare or reset.

Memory locations are addressed using an external switch. If you need up to 4 memories, you may use a simple rotary switch. If you need more than 4 memories you must use a BCD coded switch, as shown below.....

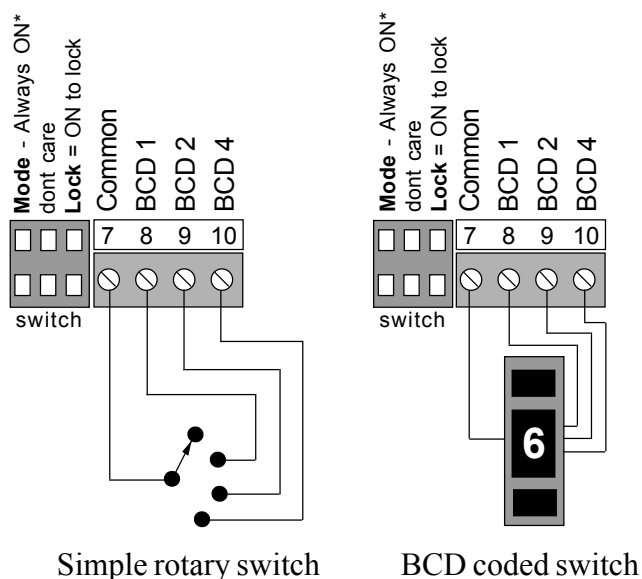

If you want to use a rotary switch to select up to 8 memory locations, and to switch up to 8 two-wire signals, switch model SW2P8W-BCD may be useful. This is a 1/8DIN unit you can order separately.

### \* Programming Notes:

Memory location 0 is a 'GLOBAL' programming location. When you programme location 0, with the Mode switch "ON", the same data will go to all other memory locations, and their settings will be lost.

Always **programme location 0 first** if you don't want to erase and over-write the data in other locations. Or, if you need less than 8 memories, you can make sure that location 0 will never be accessed if you connect a link from Common to BCD1

#### Useful trick if you must have 8 memories and need to change the calibration of location 0 ...

If you do want to change memory 0 calibration, switch the Mode switch and the Lock switch "OFF". Double check that they are off, then carry out your calibration. Remember to switch both the Mode switch and the Lock switch "ON" again when you have finished.

All programmes are stored in non-volatile EEPROM memory, which has a typical storage life of 10 years.

# Equipment Specifications

<b>Bezel size</b>	72mm high by 144 mm wide
<b>Panel Cutout</b>	67.5mm high by 138 mm wide
<b>Display</b>	Red LED 20mm high
<b>Viewing distance</b>	8 metres, average eyesight
<b>Case Depth</b>	150 mm including connectors, 130 without
<b>Weight</b>	300 grammes without options
<b>Case Material</b>	Black GRP
<b>Connectors</b>	Detachable Screw Terminal connectors
<b>Power</b>	95-265 VAC or 11-30 VDC optional
<b>Burden</b>	8VA maximum
<b>Input Signals (bipolar)</b>	4-20mA 0-10mA 0-10VDC 1-5VDC Custom Ranges
<b>Input Resistance</b>	33 Ohms 33 Ohms 1 Meg 1 Meg Ask factory
<b>Accuracy</b>	+/-0.05% of range
<b>Span tempco</b>	50ppm/Degree Celsius
<b>Zero Tempco</b>	20ppm/Degree Celsius
<b>Excitation voltage</b>	24VDC +/- 20% rated at 50mA
<b>Filtering / smoothing</b>	Selectable time constants of 0 to 5 seconds.
<b>A/D conversion</b>	Dual slope 10 conversions per second. Resolution 1 in 63000 max. over full range
<b>Display update rate</b>	2 readings per second.

## Plug-In Output Options

<b>Analogue O/P</b>	0-10VDC 4-20mA +/-5VDC
<b>Drive capacity</b>	>1K Ohms <500 Ohms >1 K Ohms
<b>Isolation</b>	250 VAC Optically isolated
<b>Linearity</b>	+/-0.02% of range, accuracy 0.1% of range
<b>Resolution</b>	12 bits
<b>Update rate</b>	10 per second (100 per second to special order)
<b>Alarm Relay O/P</b>	2 or 4 alarms SPST rated 5 Amperes at 250 VAC, resistive load. Selectable normally open or normally closed. Selectable energise or de-energise on trip.
<b>ASCII Data O/P</b>	RS232 or RS422 ASCII Value of reading. 1200 baud.
<b>Format</b>	1 start bit, 8 data, no parity. <Measurement><CR>
<b>Isolation</b>	250 VAC optically isolated

# Record of Revisions/Changes

30 October 2003  
8 March 2004

Product released  
Memory option amended

## Notes

## Notes

# Declaration of Conformity

Declaration Reference : INTUITIVE  
Issue Date : 9 October 1998  
Products Covered : INTUITIVE series  
Title : DOC-INTUITIVE

This is to confirm that the Products covered by this declaration have been designed and manufactured to meet the limits of the following EMC Standards :

EN50081-1:1992 (normative)  
EN50082-1:1992 (normative)

and have been designed to the applicable sections of the following safety standards

EN61010-1:1995

They also comply with the requirements of Council Directive 89/336/EEC relating to Electro-Magnetic Compatibility, and are designed to meet 73/23/EEC low voltage directive.

## Conditions

The meters are permitted a worst case error of 1% of A/D range during electro-magnetic disturbance, and must recover automatically when disturbance ceases without the need for human intervention, such as resetting, power-down etc.

The meters covered by this certificate must be installed in adherence to the following conditions :-

Signal cabling shall be routed separately to power carrying cabling (includes relay output wiring)  
All signal cabling shall be screened. The screen shall only be terminated to the power earth terminal

This certificate applies only to meters carrying Serial Numbers 841001 or higher.

Signed as true and correct, for and on behalf of London Electronics Ltd.

J.R. Lees Director